

---

# ***Host Command Reference***

*Q and SCL commands for servo and stepper drives*

*Includes RS-232, RS-485,  
Ethernet UDP, Ethernet TCP/IP, EtherNet/IP,  
Modbus RTU and Modbus TCP/IP*



APPLIED MOTION PRODUCTS, INC.

# Contents

<b>Getting Started.....</b>	<b>11</b>
Servo Drives .....	11
StepSERVO .....	11
Stepper Drives .....	11
<b>Commands .....</b>	<b>13</b>
Buffered Commands .....	13
Stored Programs in Q Drives.....	13
Multi-tasking in Q Drives .....	13
Immediate Commands.....	13
<b>Using Commands.....</b>	<b>13</b>
Commands in Q drives .....	14
<i>SCL Utility</i> software.....	15
<b>Command Summary .....</b>	<b>16</b>
Motion Commands.....	17
Servo Commands .....	18
Configuration Commands .....	19
Communications Commands.....	21
Register Commands .....	21
I/O Commands.....	22
Q Program Commands .....	23
<b>Command Listing.....</b>	<b>24</b>
AC - Acceleration Rate .....	25
AD - Analog Deadband.....	26
AD - Analog Deadband (SV200 Drives).....	27
AF - Analog Filter .....	28
AG - Analog Velocity Gain.....	29
AI - Alarm Reset Input .....	30
AL - Alarm Code .....	33
AM - Max Acceleration.....	36
AN - Analog Torque Gain .....	37
AO - Alarm Output .....	38
AP - Analog Position Gain .....	40
AR - Alarm Reset (Immediate).....	41
AS - Analog Scaling.....	42
AT - Analog Threshold.....	43
AV - Analog Offset Value.....	44
AV - Analog Offset Value - SV200.....	45

AX - Alarm Reset (Buffered) .....	46
AZ - Analog Zero.....	47
BD - Brake Disengage Delay .....	48
BE - Brake Engage Delay .....	49
BO - Brake Output .....	50
BR - Baud Rate .....	52
BS - Buffer Status .....	53
CA - Change Acceleration Current .....	54
CB - CANopen Baudrate.....	55
CC - Change Current.....	56
CD - Idle Current Delay Time.....	58
CE - Communication Error.....	59
CF - Anti-resonance Filter Frequency .....	60
CG - Anti-resonance Filter Gain.....	61
CI - Change Idle Current.....	62
CJ - Commence Jogging .....	64
CM - Command Mode (AKA Control Mode) .....	65
CN - Secondary Control Mode.....	67
CO - Node ID/ IP address .....	68
CP - Change Peak Current .....	69
CR - Compare Registers .....	70
CS - Change Speed.....	71
CT - Continue.....	72
DA - Define Address .....	73
DC - Change Distance .....	74
DD - Default Display Item of LEDs.....	75
DE - Deceleration.....	76
DI - Distance/Position .....	77
DL - Define Limits .....	78
DL - Define Limits (StepSERVO and SV200 drives) .....	80
DR - Data Register for Capture.....	81
DS - Switching Electronic Gearing.....	82
ED - Encoder Direction .....	83
EF - Encoder Function .....	84
EG - Electronic Gearing.....	86
EH - Extended Homing .....	87
EI - Input Noise Filter .....	89
EN - Numerator of Electronic Gearing Ratio.....	90
EP - Encoder Position.....	91

ER - Encoder Resolution .....	92
ES - Single-Ended Encoder Usage.....	93
EU - Denominator of Electronic Gearing Ratio .....	94
FA - Function of the Single-ended Analog Input .....	95
FC - Feed to Length with Speed Change .....	96
FD - Feed to Double Sensor .....	98
FE - Follow Encoder .....	99
FH - Find Home .....	100
FI - Filter Input.....	103
FL - Feed to Length .....	107
FM - Feed to Sensor with Mask Distance .....	108
FO - Feed to Length and Set Output .....	109
FP - Feed to Position .....	110
FS - Feed to Sensor.....	111
FX - Filter select inputs .....	112
FY - Feed to Sensor with Safety Distance .....	113
GC - Current Command.....	114
GG - Controller Global Gain Selection.....	115
HA - Homing Acceleration.....	116
HC – Hard Stop Current.....	117
HD - Hard Stop Fault Delay .....	118
HG - 4th Harmonic Filter Gain .....	119
HL - Homing Deceleration.....	120
HO – Home Offset .....	121
HP - 4th Harmonic Filter Phase .....	122
HS - Hard Stop Homing .....	123
HV - Homing Velocity .....	125
HW - Hand Wheel .....	126
Immediate Status Commands.....	127
IA - Immediate Analog .....	128
IC - Immediate Current (Commanded) .....	130
ID - Immediate Distance .....	131
IE - Immediate Encoder .....	132
IF - Immediate Format .....	133
IH - Immediate High Output .....	134
IL - Immediate Low Output.....	135
IO - Output Status.....	136
IP - Immediate Position.....	138
IQ - Immediate Current (Actual).....	139

IS - Input Status .....	140
IT - Immediate Temperature .....	143
IU - Immediate Voltage.....	145
IV - Immediate Velocity .....	146
IX - Immediate Position Error.....	147
JA - Jog Acceleration .....	148
JC - Velocity (Oscillator) mode second speed .....	149
JC - 8 Jog Velocities (SV200 drives).....	150
JD - Jog Disable.....	151
JE - Jog Enable.....	152
JL - Jog Decel .....	153
JM - Jog Mode .....	154
JS - Jog Speed .....	155
KC - Overall Servo Filter .....	156
KD - Differential Constant .....	157
KE - Differential Filter .....	158
KF - Velocity Feedforward Constant.....	159
KG – Secondary Global Gain .....	160
KI - Integrator Constant.....	161
KJ - Jerk Filter Frequency .....	162
KK - Inertia Feedforward Constant .....	163
KP - Proportional Constant.....	164
KV - Velocity Feedback Constant.....	165
LA - Lead Angle Max Value.....	166
LM - Software Limit CCW .....	168
LP - Software Limit CW.....	169
LS - Lead Angle Speed.....	170
LV - Low Voltage threshold.....	171
MC - Motor Current, Rated .....	172
MD - Motor Disable .....	173
ME - Motor Enable .....	174
MN - Model Number.....	175
MO - Motion Output .....	176
MR - Microstep Resolution.....	179
MS - Control Mode Selection.....	180
MT - Multi-Tasking.....	181
MV - Model & Revision .....	182
NO - No Operation .....	185
OF - On Fault .....	186

OI - On Input .....	187
OP - Option board.....	188
PA - Power-up Acceleration Current .....	189
PB - Power-up Baud Rate .....	191
PC - Power-up Current.....	192
PD - In-Position Counts .....	193
PE - In-Position Timing .....	194
PF - Position Fault.....	195
PH - Inhibit Pulse Command .....	196
PI - Power-up Idle Current .....	197
PK - Parameter Lock.....	198
PL - Position Limit .....	199
PM - Power-up Mode .....	200
PN - Probe On Demand.....	201
PP - Power-up Peak current.....	202
PR - Protocol.....	203
PS - Pause.....	204
PT - Pulse Type.....	205
PV - Secondary Electronic Gearing .....	206
PW - Password .....	207
QC - Queue Call .....	208
QD - Queue Delete .....	209
QE - Queue Execute .....	210
QG - Queue Goto.....	211
QJ - Queue Jump.....	212
QK - Queue Kill .....	213
QL - Queue Load .....	214
QR - Queue Repeat.....	215
QS - Queue Save.....	216
QU - Queue Upload .....	217
QX - Queue Load & Execute .....	218
RC - Register Counter .....	219
RD - Register Decrement.....	221
RE - Restart or Reset .....	222
RI - Register Increment.....	223
RL - Register Load - immediate .....	224
RM - Register Move .....	225
RO - Anti-Resonance ON .....	226
RR - Register Read.....	227
RS - Request Status .....	228

RU - Register Upload .....	229
RV - Revision Level .....	230
RW - Register Write .....	231
RX - Register Load - buffered .....	232
R+ - Register Add .....	233
R- - Register Subtract .....	234
R* - Register Multiply .....	235
R/ - Register Divide .....	236
R& - Register AND .....	237
RI - Register OR .....	238
SA - Save Parameters .....	239
SC - Status Code .....	240
SD - Set Direction .....	241
SF - Step Filter Frequency .....	242
SH - Seek Home .....	243
SI - Enable Input Usage .....	244
SJ - Stop Jogging .....	246
SK - Stop & Kill .....	247
SM - Stop Move .....	248
SO - Set Output .....	249
SP - Set Position .....	250
SS - Send String .....	251
ST - Stop .....	252
TD - Transmit Delay .....	253
TI - Test Input .....	254
TO - Tach Output .....	255
TR - Test Register .....	257
TS - Time Stamp .....	258
TT - Pulse Complete Timing .....	259
TV - Torque Ripple .....	260
VC - Velocity Change .....	261
VE - Velocity .....	262
VI - Velocity Integrator Constant .....	263
VL - Voltage Limit .....	264
VM - Maximum Velocity .....	265
VP - Velocity Mode Proportional Constant .....	266
VR - Velocity Ripple .....	267
WD - Wait Delay .....	268
WI - Wait for Input .....	269

WM - Wait on Move.....	270
WP - Wait Position .....	271
WT - Wait Time .....	272
ZC - Regen Resistor Continuous Wattage.....	273
ZR - Regen Resistor Value .....	274
ZT - Regen Resistor Peak Time.....	275
<b>Data Registers .....</b>	<b>276</b>
Read-Only data registers.....	276
Read/Write data registers .....	276
User-Defined data registers .....	276
Storage data registers.....	276
<b>Using Data Registers .....</b>	<b>277</b>
Loading (RL, RX) .....	277
Uploading (RL, RU).....	278
Writing Storage registers (RW) ( <i>Q drives only</i> ).....	278
Reading Storage registers (RR) ( <i>Q drives only</i> ) .....	278
Moving data registers (RM) ( <i>Q drives only</i> ) .....	278
Incrementing/Decrementing (RI, RD) ( <i>Q drives only</i> ) .....	278
Counting (RC, "I" register) ( <i>Q drives only</i> ).....	278
Math & Logic (R+, R-, R*, R/, R&, RI) ( <i>Q drives only</i> ).....	278
Conditional Testing (CR, TR) ( <i>Q drives only</i> ) .....	279
<b>Data Register Assignments.....</b>	<b>279</b>
Read-Only data registers: a - z .....	279
Read/Write data registers: A - Z .....	284
User-Defined data registers: 0 - 9, other characters .....	288
<b>Appendices .....</b>	<b>289</b>
<b>Appendix A: Non-Volatile Memory in Q drives .....</b>	<b>290</b>
<b>Appendix B: Host Serial Communications .....</b>	<b>291</b>
<b>Appendix C: Host Serial Connections .....</b>	<b>295</b>
<b>Appendix D: The PR Command .....</b>	<b>299</b>
<b>Appendix E: Alarm and Status Codes.....</b>	<b>308</b>
<b>Appendix F: Working with Inputs and Outputs .....</b>	<b>316</b>
<b>Appendix G: eSCL (SCL over Ethernet) Reference.....</b>	<b>324</b>
<b>Appendix H: EtherNet/IP.....</b>	<b>338</b>
<b>Appendix I: Troubleshooting .....</b>	<b>369</b>
<b>Appendix J: List of Supported Drives.....</b>	<b>371</b>
<b>Appendix K: Modbus appendix .....</b>	<b>378</b>
What is Modbus? .....	380



Wiring.....	380
Drive Behavior .....	381
Monitoring .....	381
Sending Commands .....	381
Examples .....	382
IO Encoding Table.....	389

(This page intentionally left blank)

# Getting Started

The basic procedures for integrating an Applied Motion drive into your application are the same for every drive offered. The first step is to configure and/or tune the drive using either *ST Configurator* (stepper) or *Quick Tuner* (servo). Depending on the specific drive, the user may now use *SCL Utility*, *Q Programmer* or *Si Programmer* software for testing and advanced programming.

## Servo Drives

- This series includes all SV7, SVAC3, SV200, BLuAC5, BLuDC9, and BLuDC4 drives.
- For Ethernet-enabled drives, see Appendix G of this document and your drive's Hardware Manual for information regarding Ethernet communications.
- Use SVX Servo Suite to tune, configure (and program) SV200 series servo drives.
- Use *Quick Tuner* software to tune and configure SV7, SVAC3, BLu series drives. See the appropriate Software Manual for details on tuning servo drives.
- For SCL applications choose the SCL Operating Mode; for Q applications choose either the SCL or Q Program Operating Mode.
- For SCL applications, the *SCL Setup Utility* is a useful tool to gain familiarity with the SCL command syntax and to test commands that will be used in the final product.
- For Q applications use *Q Programmer* both for creating stored programs and for sending commands to your drive. Note that SVX Servo Suite, used for SV200 series drives has Q Programmer built in.
- For Si applications use Si Programmer for creating stored programs.
- Note: SV7-Si and BLu-Si drives are not recommended for multi-drop communications over the RS-485 port.

## StepSERVO

- This series includes all SSM, TSM, SS, SSAC and TXM drives.
- For Ethernet-enabled drives, see Appendix G of this document and your drive's Hardware Manual for information regarding Ethernet communications.
- Use StepSERVO Quick Tuner software to tune and configure your drive. See the StepSERVO Quick Tuner Software Manual for details on tuning StepSERVO drives.
- For SCL applications choose the SCL Operating Mode; for Q applications choose either the SCL or Q Program Operating Mode.
- For SCL applications, the SCL Setup Utility is a useful tool to gain familiarity with the SCL command syntax and to test commands that will be used in the final product.
- For Q applications use Q Programmer both for creating stored programs and for sending commands to your drive.

## Stepper Drives

- This series includes all ST5/10, STM, STAC5 and STAC6 drives.
- For Ethernet-enabled drives, see Appendix G of this document and your drive's Hardware Manual for information regarding Ethernet communications.
- Use *ST Configurator* software to define your motor, configure the operating mode and encoder (if applicable), as well as any application-specific I/O requirements.

## Host Command Reference

- For SCL applications choose the SCL Operating Mode; for Q applications choose either the SCL or Q Program Operating Mode.
- For SCL applications, the *SCL Setup Utility* is a useful tool to gain familiarity with the SCL command syntax and to test commands that will be used in the final product.
- For Q applications use *Q Programmer* both for creating stored programs and for sending commands to your drive.
- For Si applications use Si Programmer for creating stored programs.
- Note: ST5/10-Si and STAC6-Si drives are not recommended for multi-drop communications over the RS-485 port.
- STAC5-Q, STAC6-Q, STAC6-QE, and STAC6-Si drives can be used in Q applications.

# Commands

There are two types of host commands available: buffered and immediate. Buffered commands are loaded into and executed out of the drive's volatile command buffer, also known as the *queue*. Immediate commands are not buffered: when received by the drive they are executed immediately.

## Buffered Commands

After being loaded into the command buffer of a drive, buffered commands are executed one at a time. (See "Multi-tasking in Q Drives" below for an exception to this rule). If you send two buffered commands to the drive in succession, like an FL (Feed to Length) command followed by an SS (Send String) command, the SS command sits in the command buffer and waits to execute until the FL command is completed. The command buffer can be filled up with commands for sequential execution without the host controller needing to wait for a specific command to execute before sending the next command. Special buffer commands, like PS (Pause) and CT (Continue), enable the buffer to be loaded and to pause execution until the desired time.

### Stored Programs in Q Drives

Stored Q Programs, created with the *Q Programmer* application software, are created by using only buffered commands. Q Programmer is built in to the configuration software for SV200 servo drives and StepSERVO products.

### Multi-tasking in Q Drives

Multi-tasking allows for an exception to the "one at a time" rule of buffered commands. The multi-tasking feature of a Q drive allows you to initiate a move command (FL, FP, CJ, FS, etc.) and proceed to execute other commands without waiting for the move command to finish. See MT command for additional details.

## Immediate Commands

Immediate commands are executed right away, running in parallel with a buffered command if necessary. For example, this allows you to check the remaining space in the buffer using the BS (Buffer Status) command, or the immediate status of digital inputs using the IS (Input Status) command, while the drive is processing other commands. Immediate commands are designed to access the drive at any time.

Applied Motion recommends waiting for an appropriate Ack/Nack response from the drive before sending subsequent commands. This adds limited overhead but ensures that the drive has received and executed the current command, preventing many common communication errors. If the Ack/Nack functionality cannot be used in the application for any reason, the user should allow a 10ms delay between commands to allow the drive sufficient time to receive and act on the last command sent.

This approach allows a host controller to get information from the drive at a high rate, most often for checking drive status or motor position.

## Using Commands

The basic structure of a command packet from the host to the drive is always a text string followed by a carriage return (no line feed required). The text string is always composed of the command itself, followed by any parameters used by the command. The carriage return denotes the end of transmission to the drive. Here is the basic syntax.

**YXXAB<cr>**

In the syntax above, "Y" symbolizes the drive's RS-485 address, and is only required when using RS-485 networking. "XX" symbolizes the command itself, which is always composed of two capital letters. "A" symbolizes the first of two possible parameters, and "B" symbolizes the second. Parameters 1 and 2 vary in length, can be letters or numbers, and are often optional. The "<cr>" symbolizes the carriage return which terminates the command string. How the carriage return is generated in your application will depend on your host software.

Once a drive receives the <cr> it will determine whether or not it understood the preceding characters as a

valid command. If it did understand the command the drive will either execute or buffer the command. If Ack/Nack is turned on (see PR command), the drive will also send an Acknowledge character (Ack) back to the host. The Ack for an executed command is % (percent sign), and for a buffered command is \* (asterisk).

It is always recommended that the user program wait for an ACK/NACK character before subsequent commands are sent. If the ACK/NACK functionality cannot be used in the application, a 10ms delay is recommended between non-motion commands.

If the drive did not understand the command it will do nothing. If Ack/Nack is turned on a Nack will be sent, which is signified by a ? (question mark). The Nack is usually accompanied by a numerical code that indicates a particular error. To see a list of these errors see the PR command details in Appendix D.

Responses from the drive will be sent with a similar syntax to the associated SCL command.

**YXX=A<cr>**

In the syntax above, “Y” symbolizes the drive’s RS-485 address, and is only present when using RS-485 networking. “XX” symbolizes the command itself, which is always composed of two capital letters. “A” symbolizes the requested data, and may be presented in either Decimal or Hexadecimal format (see the IF command). The “<cr>” symbolizes the carriage return which terminates the response string.

### Commands in Q drives

Q drives have additional functionality because commands can also be composed into a stored program that the Q drive can run stand-alone. The syntax for commands stored in a Q program is the same as if the commands were being sent directly from the host, or “XXAB”. *Q Programmer* software is used to create stored Q programs and can be downloaded for free from [www.applied-motion.com/support/software.php](http://www.applied-motion.com/support/software.php).

The diagram below shows how commands sent from the host’s serial port interact with the volatile command buffer (AKA the Queue), and the drive’s non-volatile program memory storage. Loading and Uploading the Queue contents via the serial port are done with the QL and QU commands, respectively. Similarly, the Queue’s contents can be Loaded from NV memory using the QL and QX commands, and can be saved to NV memory with the QS command. Finally, commands currently in the Queue can be executed with the QE or QX command.

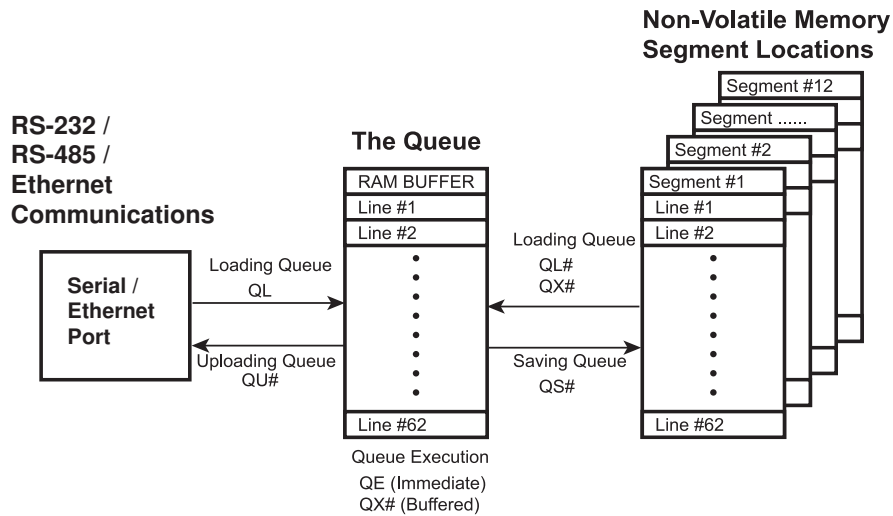

The *Q Programmer* software automates many of the functions shown in the diagram above.

## SCL Utility software

The *SCL Utility* software is an excellent application for familiarizing yourself with host commands. *SCL Utility* can be downloaded for free from [www.applied-motion.com](http://www.applied-motion.com).

To send commands to your drive from *SCL Utility* simply type a command in the Command Line and press the ENTER key to send it. (Remember that all commands are capital letters so pressing the Caps Lock key first is a good tip). Pressing the ENTER key while in *SCL Utility* does two things: it terminates the command with a carriage return and automatically sends the entire string. Try the example sequence below. In this example, note that <ENTER> means press the ENTER key on your keyboard, which is the same as terminating the command with a carriage return.

**IMPORTANT: We recommend practicing with SCL commands with no load attached to the motor shaft. You want the motor shaft to spin freely during startup to avoid damaging mechanical components in your system.**

AC25<ENTER>	Set accel rate to 25 rev/sec/sec.
DE25<ENTER>	Set decel rate to 25 rev/sec/sec
VE5<ENTER>	Set velocity to 5 rev/sec
FL20000<ENTER>	Move the motor 20000 steps in the CW direction.

If your motor didn't move after sending the FL20000 check the LEDs on your drive to see if there is an error present. If so send the AR command (AR<ENTER>) to clear the alarm. If after clearing the alarm you see a solid green LED it means the drive is disabled. Enable the drive by sending the ME command (ME<ENTER>) and verify that the you see a steady, flashing green LED. Then try the above sequence again.

Here is another sample sequence you can try.

JA10<ENTER>	Set jog accel rate to 10 rev/sec/sec
JL10<ENTER>	Set jog decel rate to 10 rev/sec/sec
JS1<ENTER>	Set jog speed to 1 rev/sec
CJ<ENTER>	Commence jogging
CS-1<ENTER>	Change jog speed to 1 rev/sec in CCW direction
SJ<ENTER>	Stop jogging

In the above sequence notice that the motor ramps to the new speed set by CS. This ramp is affected by the JA and JL commands. Try the same sequence above with different JA, JL, JS, and CS values to see how the motion of the motor shaft is affected.

## Command Summary

This section contains a set of tables that list all of the Host Commands available with your drive. In each table there are a number of columns that give information about each command.

- “Command” shows the command’s two-letter Command Code.
- “Description” shows the name of each command.
- “NV” designates which commands are Non-volatile: that is, which commands are saved in non-volatile memory when the SA (Save) command is sent to the drive. Note that certain commands (PA, PB, PC, PI, and PM) save their parameter data to non-volatile memory immediately upon execution, and need not be followed by an SA command.
- “Write only” or “Read only” is checked when a command is not both Read/Write compatible.
- “Immediate” designates an immediate command (all other commands are buffered).
- “Compatibility” shows which drives use each of the commands.

The different categories for these tables - Motion, Servo, Configuration, I/O, Communications, Q Program, Register - are set up to aid you in finding particular commands quickly.

- “Motion” commands have to do with the actual shaft rotation of the step or servo motor.
- “Servo” commands cover servo tuning parameters, enabling / disabling the motor, and filter setup.
- “Configuration” commands pertain to setting up the drive and motor for your application, including tuning parameters for your servo drive, step resolution and anti-resonance parameters for your step motor drive, etc.
- “I/O” commands are used to control and configure the inputs and outputs of the drive.
- “Communications” commands have to do with the configuration of the drive’s serial ports.
- “Q Program” commands deal with programming functions when creating stored programs for your Q drive.
- “Register” commands deal with data registers. Many of these commands are only compatible with Q drives.



## Motion Commands

Command	Description	NV	write only	read only	Immediate	Compatibility
AC	Accel Rate	•				All drives
AM	Accel Max	•				All drives
CJ	Commence Jogging		•			All drives
CS	Change Speed		•		•	All drives
DC	Distance for FC, FM, FO, FY	•				All drives
DE	Decel Rate	•				All drives
DI	Distance or Position	•				All drives
ED	Encoder Direction	•				Servos and steppers with encoder feedback
EF	Encoder Function	•				Steppers with encoder feedback
EG	Electronic Gearing	•				All drives
EH	Extended Homing		•			StepSERVO and SV200 series only
EI	Input Noise Filter	•				All drives
EP	Encoder Position					Servos and steppers with encoder feedback
FC	Feed to Length with Speed Change		•			All drives
FD	Feed to Double Sensor		•			All drives
FE	Follow Encoder		•			All drives
FH	Find Home		•			StepSERVO and SV200 series only
FL	Feed to Length		•			All drives
FM	Feed to Sensor with Mask Dist		•			All drives
FO	Feed to Length & Set Output		•			All drives
FP	Feed to Position		•			All drives
FS	Feed to Sensor		•			All drives
FY	Feed to Sensor with Safety Dist		•			All drives
HA	Homing Acceleration	•				StepSERVO and SV200 series only
HL	Homing Deceleration	•				StepSERVO and SV200 series only
HO	Homing Offset	•				StepSERVO and SV200 series only
HS	Hard Stop Homing		•			StepSERVO and SV200 series only
HV	Homing Velocity	•				StepSERVO and SV200 series only
HW	Hand Wheel		•			All drives
JA	Jog Accel/Decel rate	•				All drives
JC	Velocity mode second speed	•				All drives
JD	Jog Disable		•			All drives
JE	Jog Enable		•			All drives
JL	Jog Decel rate	•				All drives
JM	Jog Mode	•				All drives (see JM command)
JS	Jog Speed	•				All drives
MD	Motor Disable		•			All drives
ME	Motor Enable		•			All drives

## Motion Commands (continued)

Command	Description	NV	write only	read only	Immediate	Compatibility
MR	Microstep Resolution	•				Stepper drives only
PA	Power-up Accel Current	•				STM stepper drives only
SD	Set Direction	•				STM stepper drives with Flex I/O only
SH	Seek Home		•			All drives
SJ	Stop Jogging		•		•	All drives
SM	Stop the Move		•			Q drives only
SP	Set Absolute Position					All drives
ST	Stop Motion		•		•	All drives
VC	Velocity for Speed Change (FC)	•				All drives
VE	Velocity Setting (For Feed Commands)	•				All drives
VM	Velocity Max	•				All drives
WM	Wait on Move		•			Q drives only
WP	Wait on Position		•			Q drives only

## Servo Commands

Command	Description	NV	write only	read only	Immediate	Compatibility
CP	Change Peak Current	•				Servo drives only
EP	Encoder Position					Servo drives only
GC	Current Command	•			•	Servo drives only
IC	Immediate Current Command			•	•	Servo drives only
IE	Immediate Encoder Position			•	•	Servo drives only
IQ	Immediate Actual Current			•	•	Servo drives only
IX	Immediate Position Error			•	•	Servo drives only
KC	Overall Servo Filter	•				Servo drives only
KD	Differential Constant	•				Servo drives only
KE	Differential Filter	•				Servo drives only
KF	Velocity Feedforward Constant	•				Servo drives only
KG	Global Gain 1	•				SV200 series only
KI	Integrator Constant	•				Servo drives only
KJ	Jerk Filter Frequency	•				SV7 Servo drives only
KK	Inertia Feedforward Constant	•				Servo drives only
KP	Proportional Constant	•				Servo drives only
KV	Velocity Feedback Constant	•				Servo drives only
PF	Position Fault	•				Servo drives, drives with encoder feedback
PL	Position Limit	•				Servo drives only
PP	Power-Up Peak Current	•				Servo drives only
VI	Velocity Integrator Constant	•				Servo drives only
VP	Velocity Mode Proportional Constant	•				Servo drives only

## Configuration Commands

Command	Description	NV	write only	read only	Immediate	Compatibility
AL	Alarm Code			•	•	All drives
AR	Alarm Reset		•		•	All drives
BD	Brake Disengage Delay time	•				All drives
BE	Brake Engage Delay time	•				All drives
BS	Buffer Status			•	•	All drives
CA	Change Acceleration Current	•				STM stepper drives only
CC	Change Current	•				All drives
CB	CANopen baud rate	•				SV200 series only
CD	Idle Current Delay	•				Stepper drives only
CF	Anti-resonance Filter Frequency	•				Stepper drives only
CG	Anti-resonance Filter Gain	•				Stepper drives only
CI	Change Idle Current	•				Stepper drives only
CM	Control mode	•				All drives
CO	CANopen Node ID / IP Address Index Number	•				SV200 series only
CP	Change peak current	•				Servo drives only
DA	Define Address	•				All drives
DD	Default Display for Front Panel	•			•	SV200 series only
DL	Define Limits	•				All drives
DR	Data Register for Capture		•			Q servo drives only
ED	Encoder Direction	•				Servo drives, drives with encoder feedback
EN	Electronic Gearing Ratio Numerator	•				SV200 series only
ER	Encoder or Resolution	•				Servo drives, drives with encoder feedback
EU	Electronic Gearing Ratio Denominator	•				SV200 series only
HC	Hard Stop Current	•				StepSERVO and SV200 series only
HG	4th Harmonic Filter Gain	•				Stepper drives only
HP	4th Harmonic Filter Phase	•				Stepper drives only
IA	Immediate Analog			•	•	All drives
ID	immediate Distance			•	•	All drives
IE	Immediate Encoder			•	•	Servo drives, drives with encoder feedback
IF	Immediate Format	•			•	All drives
IQ	Immediate Current			•	•	Servo drives only
IP	Immediate Position			•	•	All drives
IT	Immediate Temperature			•	•	All drives
IU	Immediate Voltage			•	•	All drives
IV	Immediate Velocity			•	•	All drives
LM	Software Travel Limit CCW					StepSERVO and SV200 series only

## Configuration Commands (continued)

Command	Description	NV	write only	read only	Immediate	Compatibility
LP	Software Travel Limit CW					StepSERVO and SV200 series only
LV	Low Voltage Threshold	•				All drives
MD	Motor Disable				•	All drives
ME	Motor Enable				•	All drives
MN	Model Number			•	•	All drives
MO	Motion Output	•				All drives
MR	Microstep Resolution	•				All drives (deprecated - see EG command)
MS	Control Mode Select	•				SV200 series only
MV	Model & Revision			•	•	All drives except Blu servos
OF	On Fault		•			Q drives only
OI	On Input		•			Q drives only
OP	Option Board	•		•	•	All drives
PA	Power-up Acceleration Current	•				
PC	Power up Current	•				All drives
PD	In Position Counts	•				StepSERVO and SV200 series only
PE	In Position Timing	•				StepSERVO and SV200 series only
PF	Position Fault	•				Servo drives, drives with encoder feedback
PI	Power up Idle Current	•				Stepper drives only
PK	Parameter Lock	•				SV200 series only
PL	In Position Limit	•				Servo drives only
PM	Power up Mode	•				All drives
PP	Power up peak current	•				Servo drives only
PT	Pulse Type	•				All drives
PW	Pass Word		•			Q drives only
RE	Restart / Reset		•		•	All drives
RL	Register Load				•	All drives
RS	Request Status			•	•	All drives
RV	Revision Level			•	•	All drives
SA	Save all NV Parameters		•			All drives
SC	Status Code			•	•	
SD	Set Direction	•				STM stepper drives with Flex I/O only
SF	Step Filter Frequency	•				Stepper drives only
SI	Enable Input usage	•				All drives
SK	Stop & Kill		•		•	All drives
TT	Pulse Complete Timing	•				StepSERVO and SV200 series only

## Configuration Commands (continued)

Command	Description	NV	write only	read only	Immediate	Compatibility
TV	Torque Value	•				SV200 series only
VR	Velocity Ripple Value	•				SV200 series only
ZC	Regen Resistor Continuous Wattage	•				BLuAC5 and STAC6 drives only
ZR	Regen Resistor Value	•				BLuAC5 and STAC6 drives only
ZT	Regen Resistor Peak Time	•				BLuAC5 and STAC6 drives only

## Communications Commands

Command	Description	NV	write only	read only	Immediate	Compatibility
BR	Baud Rate	•				All drives
BS	Buffer Status				•	All drives
CE	Communications Error				•	All drives
IF	Immediate Format	•			•	All drives
PB	Power up Baud Rate	•				All drives
PR	Protocol	•				All drives
TD	Transmit Delay	•				All drives

## Register Commands

Command	Description	NV	write only	read only	Immediate	Compatibility
CR	Compare Register		•			Q drives only
DR	Data Register for Capture		•			Q drives only
RC	Register Counter		•			Q drives only
RD	Register Decrement		•			Q drives only
RI	Register Increment		•			Q drives only
RL	Register Load				•	Q drives only
RM	Register Move		•			Q drives only
RR	Register Read		•			Q drives only
RU	Register Upload		•		•	
RW	Register Write		•			Q drives only
RX	Register Load					Q drives only
R+	Register Addition		•			Q drives only
R-	Register Subtraction		•			Q drives only
R*	Register Multiplication		•			Q drives only
R/	Register Division		•			Q drives only
R&	Register Logical AND		•			Q drives only
RI	Register Logical OR		•			Q drives only
TR	Test Register		•			Q drives only
TS	Time Stamp read		•			Q drives only

## I/O Commands

Command	Description	NV	write only	read only	Immediate	Compatibility
AD	Analog Deadband	•				All stepper drives and SV servo drives
AF	Analog Filter	•				All drives
AG	Analog Velocity Gain	•				All stepper drives and SV servo drives
AI	Alarm Input usage	•				All drives
AN	Analog Torque Gain	•				StepSERVO and SV200 series only
AO	Alarm Output usage	•				All drives
AP	Analog Position Gain	•				All drives
AS	Analog Scaling	•				All stepper drives and SV servo drives
AT	Analog Threshold	•				All drives
AV	Analog Offset	•				All drives
AZ	Analog Zero (Auto Zero)		•			All drives
BD	Brake Disengage Delay time	•				All drives
BE	Brake Engage Delay time	•				All drives
BO	Brake Output usage	•				All drives
CN	Second Control Mode	•				SV200 series only
DL	Define Limits	•				All drives
DS	Dividing Select	•				SV200 series only
EI	Input Noise Filter	•				All drives
FI	Filter Input	•				All drives (Note: not NV on Blu servos)
FX	Filter Selected Inputs					Blu, STAC5, STAC6, SVAC3
GG	Gain Select	•				SV200 series only
IH	Immediate High Output		•		•	All drives
IL	Immediate Low Output		•		•	All drives
IO	Output Status				•	All drives
IS	Input Status request			•	•	All drives
MO	Motion Output	•				All drives
OI	On Input		•			Q drives only
PH	Pulse Command Inhibit	•				SV200 series only
PV	Second Electronic Gearing Setting	•				SV200 series only
SI	Enable Input usage	•				All drives
SO	Set Output		•			All drives
TI	Test Input		•			Q drives only
TO	Tach Output Setting	•				SV200 series and TSM series only
WI	Wait on Input		•			All drives

## Q Program Commands

Command	Description	NV	write only	read only	Immediate	Compatibility
AX	Alarm Reset		•			All drives
CT	Continue		•		•	All drives
MT	Multi-Tasking					Q drives only
NO	No Operation		•			Q drives only
OF	On Fault		•			Q drives only
OI	On Input		•			Q drives only
PS	Pause		•			All drives
QC	Queue Call		•			Q drives only
QD	Queue Delete		•			Q drives only
QE	Queue Execute		•		•	Q drives only
QG	Queue Goto		•			Q drives only
QJ	Queue Jump		•			Q drives only
QK	Queue Kill		•			Q drives only
QL	Queue Load		•		•	Q drives only
QR	Queue Repeat		•			Q drives only
QS	Queue Save		•		•	Q drives only
QU	Queue Upload			•	•	Q drives only
QX	Queue Load & Execute		•			Q drives only
SM	Stop Move		•			Q drives only
SS	Send String		•			All drives
TI	Test Input		•			Q drives only
WD	Wait Delay using Data Register		•			Q drives only
WI	Wait for Input		•			All drives
WM	Wait for Move to complete		•			Q drives only
WP	Wait for Position in complex move		•			Q drives only
WT	Wait Time		•			All drives

# Command Listing

This section is an alphabetical listing of all the commands available with your drive. Each page in this section contains the details of one available command. Below is a sample of what these pages look like, with an explanation of the information you will find on each page.

## DI - Distance/Position

Compatibility: All drives  
 Affects: All move commands  
 See also: AC, DC, DE and VE commands

Sets or requests the move distance in encoder counts (servo) or steps (stepper). The sign of DI indicates move direction: no sign means CW and "-" means CCW. DI sets both the distance for relative moves, like FL, and the position for absolute moves, like FP. DI also sets the direction of rotation for jogging (CJ).

### Command Details:

Structure	DI(Parameter #1)
Type	BUFFERED
Usage	READ/WRITE
Non-Volatile	YES
Register Access	"D" (020)

### Parameter Details:

Parameter #1	distance
- units	encoder counts (servo) or steps (stepper)
- range	-2,147,483,647 to 2,147,483,647 sign determines direction: "-" for CCW, no sign for CW

### Examples:

Command	Drive sends	Notes
DI20000	-	Set distance to 20000 counts in the CW direction
DI	DI=20000	
DI-8000	-	Set distance to 8000 counts in the CCW direction
FL	-	Initiate FL move

**Title** - shows the command's two-letter code followed by the command's name.

**Compatibility** - shows which drives use this command.

**Affects** - a summary of parameters or other commands the command affects.

**See Also** - related commands

**Description** - an explanation of what the command does and how it works.

**Command Details** - shows the command's Structure, Type, Usage, Non-Volatile status, and Register Access. Structure always shows the two-letter command code followed by the number of parameters it uses. Not all commands have parameters, some commands have optional parameters, and other commands always have a parameter. Optional parameters are designated by { }, and required parameters are designated by ( ). Type can be BUFFERED or IMMEDIATE. Usage can be Read Only, Read/Write, or Write Only. Non-Volatile will show if the command can be saved (YES) or not (NO). Saving Non-Volatile commands to memory requires the SA (Save) command. Register Access shows any data registers associated with the command. If the command transfers data to a register that is accessible via the RL and RX commands, that register will be shown here.

**Parameter Details** - shows a description, the units, and the range of the parameter(s) available with a given command. Some commands will also have a **Response Details** section which shows how the drive's response to the given command is formatted.

**Examples** - shows what to expect when you use this command. Under "Command" are the command strings you would send from a host controller or write into a stored program. Under "Drive Sends" are the responses from the drive: no response from the drive is denoted by "-". "Notes" give additional information about the results of the command string.



## AC - Acceleration Rate

Compatibility: All drives  
 Affects: FC, FD, FE, FL, FM, FS, FP, FY, SH commands  
 See also: AM, DE, DI, DC, VE commands

Sets or requests the acceleration rate used in point-to-point move commands in rev/sec/sec.

### Command Details:

Structure	AC{Parameter #1}
Type	BUFFERED
Usage	READ/WRITE
Non-Volatile	YES
Register Access	"A" (017) Note: Units of AC command and "A" register are different. See Data Registers section for details of "A" register.

### Parameter Details:

Parameter #1	Acceleration rate
- units	rev/sec/sec (rps/s)
- range	0.167 to 5461.167 (resolution is 0.167 rps/s)

### Examples:

Command	Drive sends	Notes
AC100	-	Set Acceleration to 100 rev/sec/sec
AC	AC=100	
AC25	-	Set acceleration rate to 25 rev/sec/sec
DE25	-	Set deceleration rate to 25 rev/sec/sec
VE1.5	-	Set velocity to 1.5 rev/sec
FL20000	-	Execute Feed to Length move of 20000 steps

## AD - Analog Deadband

Compatibility: All stepper drives and SV servo drives  
 Affects: Analog input  
 See also: CM command

Sets or requests the analog deadband value in millivolts. The deadband value is the zone around the “zeroed” value of the analog input. This deadband defines the area of the analog input range that the drive should interpret as “zero”. This zero point can be used as the zero velocity point in analog velocity mode, or as the zero position point in analog position mode (see CM command). The deadband is an absolute value that in usage is applied to either side of the zero point.

Note that in Analog Positioning mode (CM22), the AD setting is used as a hysteresis value rather than a standard deadband setting. As such, it will work over the entire analog range, not just at zero volts.

### Command Details:

Structure	AD{Parameter #1}
Type	BUFFERED
Usage	READ/WRITE
Non-Volatile	YES
Register Access	Setting the AD command will affect the contents of the “a” (Analog Command) register

### Parameter Details:

Parameter #1	Analog deadband value
- units	millivolts
- range	0 - 255

### Examples:

Command	Drive sends	Notes
AD100	-	Set analog deadband to 0.1 volts
AD	AD=100	

## AD - Analog Deadband (SV200 Drives)

Compatibility: SV200 drives  
 Affects: Analog input  
 See also: AV, AF, AS commands

Sets or requests the analog dead band value of the analog input in millivolts. The dead band value is the zone around the “zeroed” value of the analog input. This dead band defines the area of the analog input range that the drive should interpret as “zero”. The dead band is an absolute value that in usage is applied to either side of the zero point.

The command has two parameters: the first parameter selects the analog channel (Range: 1~3); the second parameter set the dead band value of the selected analog channel (Range:0~255).

- 1 – select analog channel 1
- 2 – select analog channel 2
- 3 – select differential analog

### Command Details:

Structure	AD{Parameter #1}{Parameter #2}
Type	BUFFERED
Usage	READ/WRITE
Non-Volatile	YES
Register Access	NONE

### Parameter Details:

Parameter #1	Analog channel
- units	None
- range	1~3
Parameter #2	Analog dead band value
- units	millivolts
- range	0~255
Default value	0

### Examples:

Command	Drive sends	Notes
AD110	%	Set the dead band of Ain1 to 10 mV
AD1	AD1=10	The dead band of Ain1 is 10 mV

## AF - Analog Filter

Compatibility: All drives  
 Affects: All commands using the analog inputs  
 See also: IA, CM commands

Applies a digital filter to the analog input(s). This is a simple single pole filter that rolls off the analog input. The filter value of the AF command is related to the desired value of the analog filter in Hz by the following equation:

$$\text{Filter value} = 72090 / [ (1400 / x) + 2.2 ]$$

where x = desired value of the analog filter in Hz

### Command Details:

Structure	AF{Parameter #1}
Type	BUFFERED
Usage	READ/WRITE
Non-Volatile	YES
Register Access	Setting the AF command will affect the responsiveness of the "a", "j", and "k" registers to changes in analog voltage

### Parameter Details:

Parameter #1	Filter value
- units	integer (see formula above)
- range	0 - 32767* (0 disables the filter)

\* An AF value of 28271 equates to 4000.425 Hz. Setting the AF command to anything higher than 28271 has a negligible effect on the analog filter. In other words, the maximum value of the filter is approximately 4000 Hz.

### Examples:

Command	Drive sends	Notes
AF5000	-	Make the analog input bandwidth 114.585 Hz
AF	AF=5000	

## AG - Analog Velocity Gain

Compatibility: All stepper drives and SV servo drives  
 Affects: Analog velocity modes  
 See also: CM command

Sets or requests the gain value used in analog velocity / oscillator modes. The gain value is used to establish the relationship between the analog input and the motor speed. The units are 0.25 rpm. For example, if the analog input is scaled to 0 - 5 volt input and the gain is set to 2400, when 5 volts is read at the analog input the motor will spin at 10 rps. TIP: To set the analog velocity gain to the desired value, multiply the desired motor speed in rps by 240, or the desired motor speed in rpm by 4.

### Command Details:

Structure	AG{Parameter #1}
Type	BUFFERED
Usage	READ/WRITE
Non-Volatile	YES
Register Access	None

### Parameter Details:

Parameter #1	Analog velocity gain value
- units	0.25 rpm
- range	-32767 to 32767

### Examples:

Command	Drive sends	Notes
AG3000	-	Set top speed of analog velocity mode to 12.5 rps
AG	AG=3000	

## AI - Alarm Reset Input

Compatibility: All drives, see below  
 Affects: Alarm Reset input usage  
 See also: AL, CM, DL, SI, SD commands

### BLu, SV, STAC6, ST-Q/Si

Defines the function of the X4 input. This input can be used to clear a drive fault and reset the Alarm Code (see AL command). When the Alarm Reset function is not needed at input X4, such as when operating with a host controller where faults and alarms can be cleared via serial commands, it may be useful to reconfigure X4 as a general purpose input, which allows it to be used by other types of input commands.

There are three Alarm Reset Input states that can be defined with the AI command:

**AI1:** For normal operation the X4 input must be open (inactive, high). Alarm reset occurs when the input is closed (active, low). This is an edge-triggered event. If the switch is closed when an alarm is activated no reset will occur. The input must be opened (inactive, high) and then closed to reset the alarm.

**AI2:** For normal operation the X4 input must be closed (active, low). Alarm reset occurs when the input is opened (inactive, high). This is an edge-triggered event. If the switch is open when an alarm is activated no reset will occur. The input must be closed and then opened to reset the alarm.

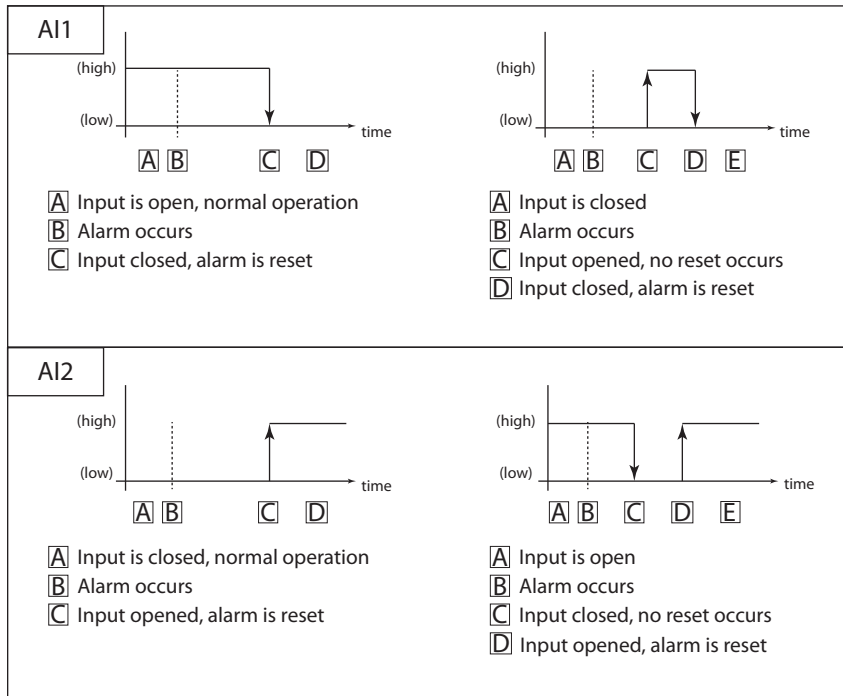

**AI3:** Input is not used for Alarm Reset and can be used as a general purpose input.

### ST-S, STM17, STM23

Defines the EN input as an Alarm Reset Input. If you want to use the EN input as an Alarm Reset input you can define it as such in two ways, with the *ST Configurator* software, or with the AI command. AI takes no effect if the drive is set in Command Mode (CM) 13, 14, 17 or 18, because these modes use the EN input as a speed change input and take precedence over the AI command. Also, setting the SI command after setting the AI command reassigns the EN input to drive enable usage and turns off any alarm reset usage (AI3). In other words, the AI and SI commands, as well as Command Modes (CM) 13, 14, 17 and 18 each assign a usage to the EN input. Each of these must exclusively use the EN input.

There are three Alarm Reset Input states that can be defined with the AI command:

**AI1:** For normal operation the EN input must be open (inactive, high). Alarm reset occurs when the EN input is closed (active, low). This is an edge-triggered event. If the switch is closed when an alarm is activated no reset will occur. The input must be opened and then closed to reset the alarm. After the alarm is cleared, the drive will be enabled when the input is opened again.

AI2 : For normal operation the EN input must be closed (active, low). Alarm reset occurs when the input is opened (inactive, high). This is an edge-triggered event. If the switch is open when an alarm is activated no reset will occur. The input must be closed and then opened to reset the alarm. After the alarm is cleared, the drive will be enabled when the input is closed again.

AI3: The EN Input is not used for Alarm Reset and may be used as a general purpose input. AI will be automatically set to 3 if CM is set to 13, 14, 17, or 18 or if SI is set to either 1 or 2 after the AI command is set.

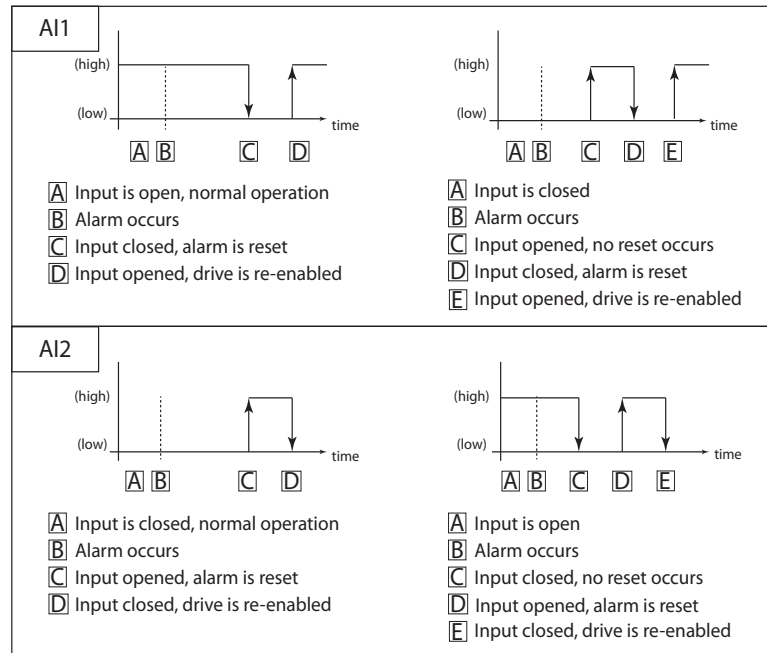

**STM24**

Drives with Flex I/O allow a second parameter which allows the user to specify the I/O point used as the Alarm Reset input. Before an I/O point can be used as an Alarm Reset input it must first be configured as an input with the SD command. See the STM24 Hardware Manual for details of which inputs may be used as the Alarm Reset input.

Possible uses for the AI command on the STM24 are as follows ('n' denotes the I/O point to be used):

AI1n: For normal operation the designated input 'n' must be open (inactive, high). Alarm reset occurs when the input is closed (active, low). This is an edge-triggered event. If the switch is closed when an alarm is activated no reset will occur. The input must be opened (inactive, high) and then closed to reset the alarm. The drive will be enabled when the input is returned to the opened state (inactive, high), unless the SI command has been used to configure hardware enable functionality.

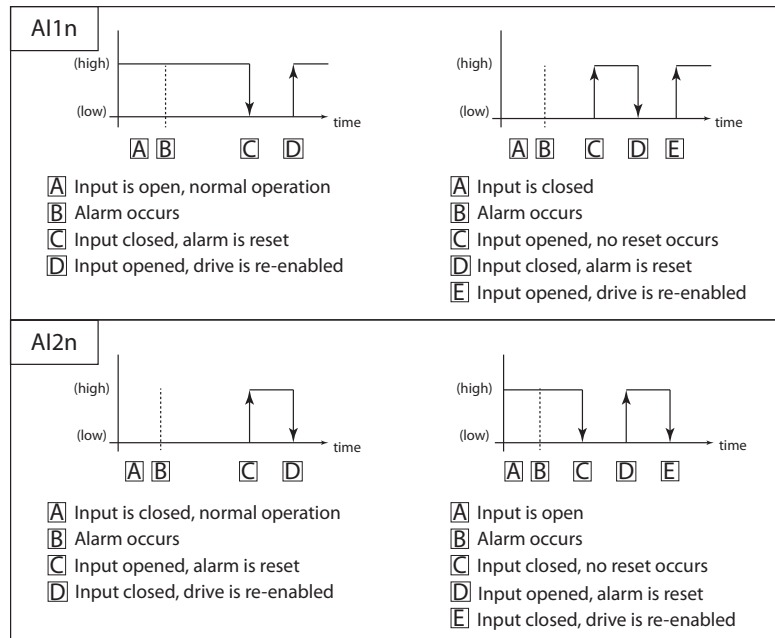

AI2n: For normal operation the designated input 'n' input must be closed (active, low). Alarm reset occurs when the designated input is opened (de-energized). This is an edge-triggered event. If the switch is open when an alarm is activated no reset will occur. The input must be closed (energized) and then opened to reset the alarm. The drive will be enabled when the input is returned to the closed state

(active, low), unless the SI command has been used to configure hardware enable functionality.

AI3n: The designated input 'n' is not used for Alarm Reset and may be used as a general purpose input.

*NOTE: A rule of thumb when using the Alarm Reset function is to toggle the designated input twice whenever an alarm occurs. That is, if the input is normally open (inactive, high), it should be closed and then opened again. If the input is normally closed (active, low), it should be opened and then closed again.*

### Command Details:

Structure	AI{Parameter #1}{Parameter #2 (Flex I/O only)}
Type	BUFFERED
Usage	READ/WRITE
Non-Volatile	YES
Register Access	None

### Parameter Details:

Parameter #1	Input Usage
- units	integer code
- range	1, 2, or 3
Parameter #2 (Flex I/O only)	I/O Point (if applicable, see note below)
- units	Integer Code
- range	2 or 4 (See STM24 Hardware Manual for details)

#### NOTES:

- For drives equipped with Flex I/O, the SD command must be executed to set an I/O point as an input before it can be used as the Alarm Reset Input.
- Parameter #2 only applies to drives equipped with Flex I/O. Parameter #2 is not defined for drives equipped with standard I/O.

### Examples:

All drives with standard I/O:

Command	Drive sends	Notes
AI1	-	Enables input to reset alarm when closed (active, low)
AI	AI=1	

Drives with Flex I/O:

Command	Drive sends	Notes
SD4I	-	Configures I/O 4 as input (see SD command for details)
AI14	-	Assigns input 4 to reset the alarm when closed (active, low)
AI	AI=14	

*NOTE: When working with digital inputs and outputs it is important to remember the designations **low** and **high**. If current is flowing into or out of an input or output, i.e. the circuit is energized, the logic state for that input/output is defined as **low** or closed. If no current is flowing, i.e. the circuit is de-energized, or the input/output is not connected, the logic state is **high** or open. A low state is represented by the "L" character in parameters of commands that affect inputs/outputs. For example, WI3L means "wait for input 3 low", and SO1L means "set output 1 low". A high state is represented by the "H" character.*



## AL - Alarm Code

Compatibility: All drives

See also: AI, AR, AX commands, Appendix E

Reads back an equivalent hexadecimal value of the Alarm Code's 16-bit binary word.

### Command Details:

Structure	AL
Command Type	IMMEDIATE
Usage	READ ONLY
Non-Volatile	NO
Register Access	"f" (054) Note: response to AL command is a different format than the response to the RLf command. See Appendix E for details.
Units	Hexadecimal value of 16-bit binary word (see below)

### Response Details:

Hex Value	BLu	SV	STAC6	ST	STM
0001	<b>Position Limit</b>				
0002	CCW Limit				
0004	CW Limit				
0008	<b>Over Temp</b>				
0010	<b>Excess Regen*</b>	<b>Internal Voltage</b>	<b>Excess Regen</b>	<b>Internal Voltage</b>	<b>Internal Voltage</b>
0020	<b>Over Voltage</b>				
0040	<b>Under Voltage*</b>	Under Voltage	<b>Under Voltage</b>	Under Voltage	Under Voltage
0080	<b>Over Current</b>				
0100	<b>Bad Hall Sensor</b>		<b>Open Motor Winding</b>		
0200	<b>Bad Encoder</b>				(not used)
0400	Comm Error				
0800	Bad Flash				
1000	Wizard Failed		No Move		
2000	Current Foldback		Motor Resistance Out of Range	(not used)	(not used)
4000	Blank Q Segment				
8000	No Move		(not used)		

\* BLuAC drives only

NOTE: Items in **bold italic** represent Drive Faults, which automatically disable the motor. Use the OF command in a Q Program to branch on a Drive Fault.

NOTE: See Appendix E for more detailed information on Alarm Codes.

Examples:

Command	Drive sends	Notes
AL	AL=0000	No alarms
AL	AL=0001	Position limit alarm
AL	AL=0201	Position limit and bad encoder signal alarms

Response Details:

Hex Value	SSM/TSM/TXM	SS	SV200 Series
0001	<b>Position Limit</b>		
0002	CCW Limit		
0004	CW Limit		
0008	<b>Over Temp</b>		
0010	<b>Internal Voltage</b>		
0020	<b>Over Voltage</b>		
0040	Under Voltage	Under Voltage	<b>Under Voltage</b>
0080	<b>Over Current</b>		
0100	<b>Open Motor Winding</b>	<b>Open Motor Winding</b>	<b>Bad Hall</b>
0200	<b>Bad Encoder</b>		
0400	Comm Error		
0800	Bad Flash		
1000	No Move	No Move	<b>Excess Regen</b>
2000	Current Foldback		
4000	Blank Q Segment		
8000	NV Memory Double Error	NV Memory Double Error	No Move

NOTE: Items in **bold italic** represent Drive Faults, which automatically disable the motor. Use the OF command in a Q Program to branch on a Drive Fault.

NOTE: See Appendix E for more detailed information on Alarm Codes.

For SS and SV200 drives, AL command has a optional parameter 1 to read back the higher 16 bit of alarm code.

Response Details:

Hex Value	SS	SV200
0001	<b>Excess Regen</b>	<b>AC Power Phase Lost</b>
0002	Reserved	<b>Safe Torque Off</b>
0004	Reserved	Reserved
0008	Reserved	<b>Velocity Limit</b>
0010	Reserved	Voltage Warning

Examples:

Command	Drive sends	Notes
AL1	AL1=0000	No alarms
AL1	AL1=0001	Excess Regen (For SS)

Additional Alarm Description Details:

**Position Limit:** Commonly referred to as “Motor Stall” or “Following Error”, this alarm condition, which will fault the motor, occurs when the actual motor position (as measured by the feedback) is off from the target position by a value equal to or greater than the Position Fault (PF) setting for servos. For stepper systems with encoder feedback and stall prevention enabled, this value is fixed at approximately 1.8 mechanical degrees.

**Internal Voltage Out of Range:** This alarm occurs when one or more board-level voltage supplies are outside the range specified in firmware. This can be caused by a short-circuit condition at the I/O connector or a failing gate driver in the power output section.

**Current Foldback:** This alarm occurs on servo and StepSERVO products when the current output to the motor exceeds the continuous current setting for more time that allowed by the drive (typically 1 sec. max). This is common during acceleration and deceleration, so decreasing the accel/decel rate will help to eliminate the alarm.

## AM - Max Acceleration

Compatibility: All drives  
 Affects: ST, SK , SM, QK commands; analog velocity and oscillator modes  
 See also: VM command

Sets or requests the maximum acceleration/deceleration allowed when using analog velocity and oscillator modes. Also sets the deceleration rate used when an end-of-travel limit is activated during a move or when an ST (Stop) or SK (Stop & Kill) command is sent.

### Command Details:

Structure	AM{Parameter #1}
Type	BUFFERED
Usage	READ/WRITE
Non-Volatile	YES
Register Access	None

### Parameter Details:

Parameter #1	Maximum acceleration/deceleration
- units	rev/sec/sec (rps/s)
- range	0.167 - 5461.167 (resolution is 0.167 rps/s)

### Examples:

Command	Drive sends	Notes
AM2000	-	Set maximum acceleration/deceleration values to 2000 rev/sec/sec.
AM	AM=2000	

## AN - Analog Torque Gain

Compatibility: SV200 servo drives and StepSERVO models (including SSM, TSM, and TXM)  
 Affects: CM2, 3, and 4 (Analog Torque Command Modes)  
 See also: AD, AF, AZ, CM, CC, SF commands

Sets or requests the gain value used in analog torque mode. This is used to set the analog input gain that relates voltage to motor current when the drive is in analog torque mode. The analog torque gain value represents the commanded current in units of 0.01A when the analog input is at the configured full scale value. See specific analog input ranges in hardware manual for the StepSERVO or SV200 product being used.

### Command Details:

Structure	AN{Parameter #1}
Type	BUFFERED
Usage	READ/WRITE
Non-Volatile	YES
Register Access	None

### Parameter Details:

Parameter #1	Current (A rms)
- units	Amps (resolution is 0.01 A)
- range	Related to CC command range

### Examples:

Command	Drive sends	Notes
AN1	%	Current range over full scale of analog input is 1A
AN	AN=1	

## AO - Alarm Output

Compatibility: All drives  
 Affects: Alarm Output usage  
 See also: AI, BO, MO, SD, SI commands

### BLu, SV, STAC6, ST-Q/Si, SVAC3-Q/S/IP, STAC5-Q/S/IP

Defines usage of digital output Y3 for BLu, SV7, STAC6 and ST-Q/Si. STAC5 and SVAC3 use Y1. Normally this output is used to indicate an Alarm caused by a Drive Fault. This output can be reconfigured as a general purpose output for use with other types of output commands. There are three states that can be defined:

- AO1: Output is closed (active, low) when a Drive Fault is present.
- AO2: Output is open (inactive, high) when an Drive Fault is present.
- AO3: Output is not used as an Alarm Output and can be used as a general purpose output.

### ST-S, STM17, STM23, STM24-C

Defines the drive's digital output as an Alarm Output. The output of a drive can be assigned to one of five functions: Alarm Output, Brake Output, Motion Output, Tach Output or General Purpose Output. Each of these functions must exclusively use the output, so only one function is allowed. There are two ways to define the function of this output: via the *ST Configurator* or via SCL commands. To set the output as an Alarm Output, use the AO command and one of the codes below. There are three Alarm Output states that can be defined with the AO command:

- AO1: Output is closed (active, low) when a Drive Fault is present.
- AO2: Output is open (inactive, high) when a Drive Fault is present.
- AO3: Output is not used as an Alarm Output and can be used for another automatic output function or as a general purpose output.

### STM24-SF/QF

Drives with Flex I/O allow a second parameter which allows the user to specify the I/O point used. Before an I/O point can be used as an Alarm Output it must first be configured as an output with the SD command.

Possible uses for the AO command on the STM24 are as follows ('n' denotes the I/O point to be used):

- AO1n: Designated output 'n' is closed (active, low) when a Drive Fault is present.
- AO2n: Designated output 'n' is open (inactive, high) when a Drive Fault is present.
- AO3n: Designated output 'n' is not used as an Alarm Output and can be used for another automatic output function or as a general purpose output.

*NOTE: Setting the AO command to 1 or 2 overrides previous assignments of this output's function. Similarly, if you use the BO or MO command to set the function of the output after setting the AO command to 1 or 2, usage of the output will be reassigned and AO will be automatically set to 3.*

### Command Details:

Structure	AO{Parameter #1}{Parameter #2 (Flex I/O only)}
Type	BUFFERED
Usage	READ/WRITE
Non-Volatile	YES
Register Access	None

## Parameter Details:

Parameter #1	Output Usage (see above)
- units	integer code
- range	1, 2 or 3
Parameter #2 (Flex I/O only)	I/O Point (if applicable, see note below)
- units	integer code
- range	1 - 4

### NOTES:

- For drives with Flex I/O, the SD command must be executed to set an I/O point as an input or output before that output can be designated as the Alarm Output.
- Parameter #2 only applies to drives equipped with Flex I/O. This includes the STM24SF and STM24QF. Parameter #2 is not defined for drives equipped with standard I/O.

## Examples:

### All drives with standard I/O:

Command	Drive sends	Notes
AO1	-	Alarm Output will close when a Drive Fault occurs
AO	AO=1	

### Drives with Flex I/O only:

Command	Drive sends	Notes
SD4O	-	Configures I/O 4 as output (see SD command for details)
AO14	-	Alarm Output is mapped to output #4, and will close when a Drive Fault occurs.
AO	AO=14	

**NOTE:** When working with digital inputs and outputs it is important to remember the designations **low** and **high**. If current is flowing into or out of an input or output, i.e. the circuit is energized, the logic state for that input/output is defined as **low** or closed. If no current is flowing, i.e. the circuit is de-energized, or the input/output is not connected, the logic state is **high** or open. A low state is represented by the "L" character in parameters of commands that affect inputs/outputs. For example, WI3L means "wait for input 3 low", and SO1L means "set output 1 low". A high state is represented by the "H" character.

## AP - Analog Position Gain

Compatibility: All drives  
 Affects: CM22 (Analog Positioning Command Mode)  
 See also: AD, AF, AZ, CM, SF commands

Sets or requests the analog Input gain that relates to motor position when the drive is in analog position command mode (see CM command, parameter value 22). Gain value sets the commanded position when the analog input is at the configured full scale value. *Quick Tuner* (BLu, SV), *STAC6 Configurator* (STAC6), or *ST Configurator* (ST, STM) can be used to configure the analog inputs for the desired input type, scaling and offsetting.

### Command Details:

Structure	AP{Parameter #1}
Type	BUFFERED
Usage	READ/WRITE
Non-Volatile	YES
Register Access	"X" (040)

### Parameter Details:

Parameter #1	Analog position gain value
- units	encoder counts
- range	0 - 32767

### Examples:

Command	Drive sends	Notes
AP8000	-	Position range over full scale of analog input is 8000 steps
AP	AP=8000	



---

## AR - Alarm Reset (Immediate)

---

Compatibility: All drives  
 Affects: Alarm Code  
 See also: AL, ME, MD commands

Clears Alarms and Drive Faults. If an Alarm or Drive Fault condition persists after sending the AR command the Alarm is not cleared.

*NOTE: Does not re-enable the drive. Use ME (Motor Enable) command to re-enable drive.*

### Command Details:

Structure	AR
Type	IMMEDIATE
Usage	WRITE ONLY
Non-Volatile	NO
Register Access	None

### Examples:

Command	Drive sends	Notes
AR	-	Reset Drive Fault and clear Alarm Code (if possible)

## AS - Analog Scaling

Compatibility: All stepper drives and SV servo drives  
 Affects: Analog input  
 See also: CM command

Sets or requests the analog input scaling setting. This is a code that determines what type of analog input scaling is desired. The codes for selecting the various settings are in the Details table below.

### Command Details:

Structure	AS{Parameter #1}
Type	BUFFERED
Usage	READ/WRITE
Non-Volatile	YES
Register Access	None

### Parameter Details:

Parameter #1	Code
- units	integer number
- range	0 = single-ended +/- 10 volts 1 = single-ended 0 - 10 volts 2 = single-ended +/- 5 volts 3 = single-ended 0 - 5 volts 4 = differential +/- 10 volts 5 = differential 0 - 10 volts 6 = differential +/- 5 volts 7 = differential 0 - 5 volts
- range (SV200 series)	0 = single-ended +/- 10 volts 1 = single-ended 0 - 10 volts

### Examples:

Command	Drive sends	Notes
AS2	-	Analog input scaling set to single-ended +/- 5 volts
AS	AS=2	

## AT - Analog Threshold

Compatibility: All drives  
 Affects: All "Feed to Sensor" type commands  
 See also: AF, AZ, FS, FY, FD commands

Sets or requests the Analog Input Threshold that is used by the "Feed to Sensor" command. The threshold value sets the Analog voltage that determines a sensor state or a trigger value.

### Command Details:

Structure	AT{Parameter #1}
Type	BUFFERED
Usage	READ/WRITE
Non-Volatile	YES
Register Access	"Y" (041)

### Parameter Details:

Parameter #1	Analog threshold value
- units	volts
- range	BLu, SV, STAC6, ST-Q/Si, STAC5, SVAC3: -10.000 to 10.000 ST-S, STM: 0.000 to 5.000

### Examples:

Command	Drive sends	Notes
AT4.5	-	Analog input threshold set to 4.5 volts
AT	AT=4.5	

## AV - Analog Offset Value

Compatibility: All drives (except SV200 series)  
 Affects: All Analog input functions  
 See also: AF, AP, AZ, CM & Feed commands

Sets or requests the analog offset value in volts.

### Command Details:

Structure	AV{Parameter #1}
Type	BUFFERED
Usage	READ/WRITE
Non-Volatile	YES
Register Access	"Z" (042) Note: Units of AV command are different than units of "Z" register; see Data Registers section for more details

### Parameter Details:

Parameter #1	Analog offset value
- units	Volts
- range	BLu, SV, STAC6, ST-Q/Si, STAC5, SVAC3: -10.000 to 10.000 ST-S, STM: -5.000 to 5.000

### Examples:

Command	Drive sends	Notes
AV0.25	-	Set analog offset to 0.25 Volts
AV	AV=0.25	

## AV - Analog Offset Value - SV200

Compatibility: SV200 drives  
 Affects: Analog inputs  
 See also: AD, AF, AS commands

Sets or requests the offset value of the analog input in volts.

The command has two parameters: the first parameter selects the analog channel (Range: 1~3); the second parameter set the offset value of the selected analog channel (Range: -10~10).

- 1 – select analog channel 1
- 2 – select analog channel 2
- 3 – select differential analog

### Command Details:

Structure	AV{Parameter #1}{Parameter #2}
Type	BUFFERED
Usage	READ/WRITE
Non-Volatile	YES
Register Access	None

### Parameter Details:

Parameter #1	Analog channel
- units	None
- range	1~3
Parameter #2	Analog offset value
- units	volts
- range	0~255
Default value	0

### Examples:

Command	Drive sends	Notes
AV11	%	set the offset of Ain1 to 1V
AV1	AV1=1	the offset of Ain1 is 1V

## AX - Alarm Reset (Buffered)

Compatibility: All drives  
 Affects: Alarm Code  
 See also: AR, ME, OF, WT Commands

Clears Alarms and Drive Faults. This command functions the same as AR (Alarm Reset) but is a Buffered type command.

Typically used in conjunction with OF within a Q program. Please note that while immediately executing AX will clear the alarm code, it does not guarantee that the condition that caused the alarm has been resolved. Therefore it is recommended to include a short delay or wait for user input before clearing the alarm and resuming normal operation.

In addition to clearing alarms and faults, the AX command resets the LED blink timer. As such, if the AX command is used within a tight loop in a Q program, the LED may actually appear to be solid green.

*NOTE: Does not re-enable the drive. Use ME (Motor Enable) command to re-enable drive.*

### Command Details:

Structure	AX
Type	BUFFERED
Usage	WRITE ONLY
Non-Volatile	NO
Register Access	None

### Examples:

Command	Drive sends	Notes
<i>In segment 1 of a Q program...</i>		
OF9	-	When a drive fault occurs load and execute program segment 9
<i>In segment 9 of the same Q program...</i>		
WT0.1	-	Short delay to allow the system to settle
AX	-	Alarm reset
ME	-	Motor enable
QX1	-	Load and execute segment 1, which will also reset the OF function.

## AZ - Analog Zero

Compatibility: All drives  
 Affects: All Analog input functions  
 See also: AF, AP, AV, CM & Feed commands

Activates the analog “auto offset” algorithm. It is useful in defining the current voltage present at the analog input as the zero reference point, or offset.

### Command Details:

Structure	AZ
Type	BUFFERED
Usage	WRITE ONLY
Non-Volatile	NO
Register Access	None

### Examples:

Command	Drive sends	Notes
AZ	-	Start analog offset algorithm

Example: Apply 1 VDC across the AIN and GND terminals of the drive. Then send the AZ command to the drive. Next apply 4 VDC across the AIN and GND terminals. Send the IA command and the response will be very close to IA=3.00 (or 4 - 1 VDC).

## BD - Brake Disengage Delay

Compatibility: All drives  
 Affects: All "F" (Feed) and Jog commands.  
 See also: BE command

This command only takes effect if the BO command is set to 1 or 2. After a drive is enabled this is the time value that may delay a move waiting for the brake to disengage. When beginning a move the delay value must expire before a move can take place. The delay timer begins counting down immediately after the drive is enabled and the brake output is set. The BD command sets a time in milliseconds that a move may be delayed.

### Command Details:

Structure	BD{Parameter #1}
Type	BUFFERED
Usage	READ/WRITE
Non-Volatile	YES
Register Access	None

### Parameter Details:

Parameter #1	Delay time
- units	seconds
- range	0 - 32.767

### Examples:

Command	Drive sends	Notes
BD0.2	-	Sets brake disengage delay to 200 ms
BD	BD=0.2	



## BE - Brake Engage Delay

Compatibility: All drives  
 Affects: All "F" (Feed) and Jog commands.  
 See also: BD command

This command only takes effect if the BO command is set to 1 or 2. After a drive is commanded to be disabled, this is the time value that delays the actual disabling of the driver output. When using the dedicated brake output (see BO command) the output is activated immediately with the disable command, then the drive waits the delay time before turning off the motor current.

### Command Details:

Structure	BE{Parameter #1}
Type	BUFFERED
Usage	READ/WRITE
Non-Volatile	YES
Register Access	None

### Parameter Details:

Parameter #1	Delay time
- units	seconds
- range	0 - 32.767

### Examples:

Command	Drive sends	Notes
BE0.25	-	Sets brake engage delay to 250 ms
BE	BE=0.25	

---

## BO - Brake Output

---

Compatibility: All drives  
Affects: Function of digital output  
See also: AI, AO, BD, ME, MD, MO, SD, SI commands

*NOTE: The digital output circuits available on Applied Motion drives are not sized for directly driving a typical holding brake. An external relay must be wired in circuit between the digital output of the drive and the holding brake. See the appropriate drive hardware manual for an example wiring diagram.*

### BLu, SV, STAC6, ST-Q/Si

Defines usage of digital output Y1 as the Brake Output, which can be used to automatically activate and deactivate a holding brake. Output Y1 can also be configured as a general purpose output for use with other types of output commands. There are three states that can be defined:

- BO1: Output is closed (energized) when drive is enabled, and open when the drive is disabled.
- BO2: Output is open (de-energized) when drive is enabled, and closed when the drive is disabled.
- BO3: Output is not used as a Brake Output and can be used as a general purpose output.

### ST-S, STM17, STM23, STM24-C

Defines the drive's digital output as a Brake Output. The output of a drive can be assigned to one of five functions: Alarm Output, Brake Output, Motion Output, Tach Output, or General Purpose Output. Each of these functions must exclusively use the output, so only one function is allowed. There are two ways to define the function of this output: via *ST Configurator* or via SCL commands. To set the output as a Brake Output, use the BO command and one of the codes below.

- BO1: Output is closed (active, low) when the drive is enabled, and open when the drive is disabled.
- BO2: Output is open (inactive, high) when the drive is enabled, and closed when the drive is disabled.
- BO3: Output is not used as a Brake Output and can be used for another automatic output function or as a general purpose output.

### STM24-SF/QF

Drives with Flex I/O allow a second parameter which allows the user to specify the I/O point used. Before an I/O point can be used as a Brake Output it must first be configured as an output with the SD command. Possible uses for the BO command on the STM24 are as follows ('n' denotes the I/O point to be used):

- BO1n: Designated output 'n' is closed (active, low) when the drive is enabled and open when the drive is disabled.
- BO2n: Designated output 'n' is open (inactive, high) when the drive is enabled and closed when the drive is disabled.
- BO3n: Designated output 'n' is not used as a Brake Output and can be used for another automatic output function or as a general purpose output.

### STAC5-S, SVAC3-S

Defines usage of digital output Y2 as the Brake Output, which can be used to automatically activate and deactivate a holding brake. Output Y2 can also be configured as a Motion Output, a Tach Output, or a General Purpose output for use with other types of output commands. There are three states that can be defined:

- BO1: Output is closed (energized) when drive is enabled, and open when the drive is disabled.
- BO2: Output is open (de-energized) when drive is enabled, and closed when the drive is disabled.
- BO3: Output is not used as a Brake Output and can be used as a general purpose output.

**STAC5-Q/IP, SVAC3-Q/IP**

Defines usage of digital output Y2 as the Brake Output, which can be used to automatically activate and deactivate a holding brake. Output Y2 can also be configured as a Tach Output, or a General Purpose output for use with other types of output commands. There are three states that can be defined:

- BO1: Output is closed (energized) when drive is enabled, and open when the drive is disabled.
- BO2: Output is open (de-energized) when drive is enabled, and closed when the drive is disabled.
- BO3: Output is not used as a Brake Output and can be used as a general purpose output.

*NOTE: Setting the BO command to 1 or 2 overrides previous assignments of this output's function. Similarly, if you use the AO or MO command to set the function of the output after setting the BO command to 1 or 2, usage of the output will be reassigned and BO will be automatically set to 3.*

**Command Details:**

Structure	BO{Parameter #1}{Parameter #2 (Flex I/O only)}
Type	BUFFERED
Usage	READ/WRITE
Non-Volatile	YES
Register Access	None

**Parameter Details:**

Parameter #1	Output Usage (see above)
- units	integer code
- range	1, 2 or 3
Parameter #2 (Flex I/O only)	I/O Point (if applicable, see note below)
- units	integer code
- range	1 - 4

**NOTES:**

- For drives with Flex I/O, the SD command must be executed to set an I/O point as an output before that output can be assigned as the Brake Output.
- Parameter #2 only applies to drives equipped with Flex I/O. This includes the STM24SF and STM24QF. Parameter #2 is not defined for drives equipped with standard I/O.

**Examples:****All drives with standard I/O:**

Command	Drive sends	Notes
BO1	-	Brake Output will be closed when drive is enabled
BO	BO=1	

**Drives with Flex I/O only:**

Command	Drive sends	Notes
SD4O	-	Configures I/O 4 as output (see SD command for details)
BO14	-	Brake Output is mapped to I/O point 4 and will be Closed when drive is enabled
BO	BO=14	

## BR - Baud Rate

Compatibility: All drives  
 Affects: Serial communications  
 See also: TD, PB, PM, PR commands

Sets or requests the bit rate (baud) for serial communications. At power up a drive will send its power-up packet at 9600 baud. If a response from a host system (such as a software application from Applied Motion) is not detected after 1 second and the drive is configured for SCL or Q operation (see PM command) the drive will set the baud rate according to the value stored in the Baud Rate NV parameter. A Host system can set the baud rate at anytime using this command. See Appendix B, "Host Serial Communications" for details.

*NOTE 1: Setting the value takes effect immediately.*

*NOTE 2: Due to processor speed limitations, -Si drives can accept only parameter values 1, 2 or 3. -S and -Q drives will accept parameter values of 1-5.*

### Command Details:

Structure	BR{Parameter #1}
Type	BUFFERED
Usage	READ/WRITE
Non-Volatile	YES
Register Access	None

### Parameter Details:

Parameter #1	Baud rate (see above)
- units	integer code
- range	1 = 9600 bps 2 = 19200 3 = 38400 4 = 57600 (-S and -Q drives only) 5 = 115200 (-S and -Q drives only)

### Examples:

Command	Drive sends	Notes
BR2	-	Baud rate is immediately set to 19200
BR	BR=2	

## BS - Buffer Status

Compatibility: All drives  
 See also: CT, PS commands

Requests from the drive the number of available command locations in the command buffer. This technique simplifies sending commands by eliminating the need to calculate if there is enough space in the buffer for a command. If the drive responds with at least a "1", a command can be sent.

If a drive responds to the BS command with the value "63" it means the buffer is empty. If a "0" is returned the buffer is full and no more buffered commands can be accepted (a buffer overflow will occur if another command is sent).

### Command Details:

Structure	BS
Type	IMMEDIATE
Usage	READ ONLY
Non-Volatile	NO
Register Access	None
Units	Empty command spaces in buffer

### Examples:

Command	Drive sends	Notes
BS	BS=20	There is room in the buffer for 20 more commands

## CA - Change Acceleration Current

Compatibility: STM Integrated Step Motors  
 Affects: Motor accel/decel current and torque  
 See also: PA, CC, PC commands

Sets or requests the accel/decel current setting (“peak of sine”) of the stepper drive, also known as the peak current. CA will only accept parameter values equal to or larger than the current CC setting.

*NOTE: CA has no effect in Command Mode 7 (CM7 - Step and Direction mode).*

### Command Details:

Structure	CA{Parameter #1}
Type	BUFFERED
Usage	READ/WRITE
Non-Volatile	YES
Register Access	“M” (029) Note: The CA command uses different units than the “M” register; see Data Registers section for details

### Parameter Details:

Parameter #1	Accel/Decel Current
- units	amps (resolution is 0.01 amps)
- range	STM23: 0 - 5.0 STM17: 0 - 2.0

*Configurator* software may also be used to set all current levels.

### Example:

#### STM17, STM23

Command	Drive Sends	Notes
CA1.75	-	Set accel/decel current to 1.75 amps (peak of sine)
CA	CA=1.75	

## CB - CANopen Baudrate

Compatibility: SV200 series servo drives only  
 Affects: CANopen drives  
 See also: None

Sets or requests the CANopen baudrate of CANopen type drives.

0 – 1 Mbps  
 1 – 800 kbps  
 2 – 500 kbps  
 3 – 250 kbps  
 4 – 125 kbps  
 5 – 50 kbps  
 6 – 20 kbps  
 7 – 12.5 kbps

### Command Details:

Structure	CB{Parameter #1}
Type	BUFFERED
Usage	READ/WRITE
Non-Volatile	Yes
Register Access	None
Units	Empty command spaces in buffer

### Parameter Details:

Parameter #1	CANopen baudrate of C type drive
- units	Integer
- range	0~7
Default value	0

### Example:

Command	Drive Sends	Notes
CB1	%	Set the baudrate of CANopen drive to 1 Mbps
CB	CB=1	The baudrate of CANopen drive is 1 Mbps

## CC - Change Current

Compatibility: All drives  
 Affects: Motor current and torque  
 See also: CA, CI, CP, PC commands

### BLu, SV

Sets or requests the continuous (RMS) current setting of the servo drive.

### STAC6

Sets or requests the current setting (“peak of sine”) of the stepper drive, also known as the running current. The range of the CC command may be limited from the ranges shown in the Parameters table below based on the settings defined in the *STAC6 Configurator* software. Use *STAC6 Configurator* to select a motor and set the maximum current setting. Note that setting CC automatically sets CI to the same value if the new CC value is less than the starting CI value.

### ST-Q/Si, ST-S, STM

Sets or requests the current setting (“peak of sine”) of the stepper drive, also known as the running current. The range of the CC command may be limited from the ranges shown in the Parameters table below based on the settings defined in the *ST Configurator* software. Use *ST Configurator* to select a motor and set the maximum current setting. Note that setting CC automatically sets CI to 50% of CC. If a CI value different than 50% of CC is needed be sure to always set CI after setting CC.

### Command Details:

Structure	CC{Parameter #1}
Type	BUFFERED
Usage	READ/WRITE
Non-Volatile	YES
Register Access	“N” (030) Note: The CC command uses different units than the “N” register; see Data Registers section for details

### Parameter Details:

#### BLu, SV, SVAC3

Parameter #1	Continuous current setting
- units	amps rms
- range	BLuDC4: 0 - 4.5 BLuDC9: 0 - 9.0 BLuAC5: 0 - 5.0 SV: 0 - 7.0 SVAC3 (120V): 0 - 3.5 SVAC3 (220V): 0 - 1.8 Note: For StepSERVO and SV200 series, see hardware manual for peak current range.



## STAC6, ST-Q/Si, ST-S, STM, STAC5

Parameter #1	Running current
- units	amps
- range*	STAC6: 0 - 6.0 ST5 : 0 - 5.0 ST10: 0 - 10.0 STM: 0 - 5.0 STAC5 (120): 0 - 5 STAC5 (220): 0 - 2.55

\*Current setting in stepper drives depends on the selected motor. Use *Configurator* software to select a motor and set the maximum current setting.

## Examples:

## BLu, SV, SVAC3

Command	Drive sends	Notes
CC4.50	-	Set continuous current to 4.5 amps rms
CC	CC=4.5	

## STAC6

Command	Drive sends	Notes
CC4.50	-	Set running current to 4.5 amps
CI2	-	Set idle current to 2.0 amps
CC1.8	-	Set idle current to 1.8 amps
CC	CC=1.8	
CI	CI=1.8	CI automatically set to 1.8 amps along with CC1.8 command

## ST-Q/Si, ST-S, STM, STAC5

Command	Drive sends	Notes
CC3	-	Set running current to 3.0 amps
CI	CI=1.5	CI automatically set to 1.5 amps along with CC3 command
CI1	-	Set idle current to 1.0 amps

## CD - Idle Current Delay Time

Compatibility: Stepper drives only  
 Affects: Motor current at rest  
 See also: CC, CI commands

Sets or requests the amount of time the drive will delay before transitioning from full current (CC) to idle current (CI). This transition is made after a step motor takes the final step of a move. Operating in any form of pulse & direction mode the drive will reset the idle current delay timer each time a step pulse is received by the drive.

### Command Details:

Structure	CD{Parameter #1}
Type	BUFFERED
Usage	READ/WRITE
Non-Volatile	YES
Register Access	None

### Parameter Details:

Parameter #1	Delay time
- units	seconds
- range	0.00 to 10.00

### Examples:

Command	Drive sends	Notes
CD0.4	-	Idle current delay time set to 0.4 seconds
CD	CD=0.4	

## CE - Communication Error

Compatibility: All drives  
See also: AL command

Requests the hexadecimal equivalent of the communication error's 8-bit binary word. The presence of a comm error will also be shown in the Alarm Code (AL command) as well as the status LEDs at the front of the drive (Appendix F). Bit assignments for the 8-bit word are shown in the Response Details table below.

### Command Details:

Command Type	IMMEDIATE
Usage	READ ONLY
Non-Volatile	NO
Register Access	None

### Response Details:

Response	Communication error code
- units	hexadecimal code
- range	bit 0 = parity flag error bit 1 = framing error bit 2 = noise flag error bit 3 = overrun error bit 4 = Rx buffer full bit 5 = Tx buffer full bit 6 = bad SPI op-code bit 7 = Tx time-out

### Examples:

Command	Drive sends	Notes
CE	CE=0010	Rx buffer full
CE	CE=0002	Framing error

## CF - Anti-resonance Filter Frequency

Compatibility: Stepper drives only  
 Affects: Mid-range performance of step motors  
 See also: CG command

Sets or requests the anti-resonance filter frequency setting. This setting is in Hz and works in conjunction with the anti-resonance filter gain setting (CG) to cancel instabilities due to mid-band resonance.

*NOTE: We strongly suggest using the appropriate Configurator software application to set this value by entering as accurate a load inertia value as possible in the motor settings window.*

### Command Details:

Structure	CF{Parameter #1}
Type	BUFFERED
Usage	READ/WRITE
Non-Volatile	YES
Register Access	None

### Parameter Details:

Parameter #1	Filter frequency
- units	Hz
- range	1 - 2000

### Examples:

Command	Drive sends	Notes
CF1400	-	Set anti-resonance filter frequency to 1400 Hz
CF	CF=1400	

## CG - Anti-resonance Filter Gain

Compatibility: Stepper drives only  
 Affects: Mid-range performance of step motors  
 See also: CF command

Sets or requests the anti-resonance filter gain setting. This setting is unit-less and works in conjunction with the anti-resonance filter frequency setting (CF) to cancel instabilities due to mid-band resonance.

*NOTE: We strongly suggest using the appropriate Configurator software application to set this value by entering as accurate a load inertia value as possible in the motor settings window.*

### Command Structure:

CG{Parameter #1}

### Command Details:

Structure	CG{Parameter #1}
Type	BUFFERED
Usage	READ/WRITE
Non-Volatile	YES
Register Access	None

### Parameter Details:

Parameter #1	Filter gain
- units	integer number
- range	0 - 32767

### Examples:

Command	Drive sends	Notes
CG800	-	Set anti-resonance filter gain to 800
CG	CG=800	

## CI - Change Idle Current

Compatibility: Stepper drives only  
 Affects: Motor current at standstill, holding torque  
 See also: CC, PI, CD commands

Idle current is the level of current supplied to each motor phase when the motor is not moving. Using an idle current level lower than the running motor current level (see CC command) aids in motor cooling. A common level used for the idle current setting is 50% of the running current. After a motor move, there is a time delay after the motor takes its last step before the reduction to the idle current level takes place. This delay is set by the CD command.

### STAC6

CI cannot be greater than CC. If you attempt to set CI higher than CC it will be automatically limited to the CC value. Furthermore, setting CC automatically sets CI to the same value if the new CC value is less than the starting CI value.

### ST-Q/Si, ST-S, STM

CI cannot be greater than 90% of CC. If you attempt to set CI to a higher value than this CI is automatically limited to 90% of CC. Furthermore, setting CC automatically sets CI to 50% of the CC value. If a CI value different than 50% of CC is needed be sure to always set CI after setting CC.

### Command Details:

Structure	CI{Parameter #1}
Type	BUFFERED
Usage	READ/WRITE
Non-Volatile	Yes
Register Access	“O” (031) Note: The CI command uses different units than the “O” register; see Data Registers section for more details

### Parameter Details:

#### STAC6

Parameter #1	Idle current
- units	amps
- range	0 - 100% of running current

#### ST-Q/Si, ST-S, STM, STAC5

Parameter #1	Idle current
- units	amps
- range	0 - 90% of running current

## Examples:

## STAC6

Command	Drive sends	Notes
CI1.0	-	Set idle current to 1.0 amps
CI	CI=1	
CC0.5	-	Set running current to 0.5 amps
CI	CI=0.5	CI automatically set 0.5 amps along with CC0.5 command

## ST-Q/Si, ST-S, STM, STAC5

Command	Drive sends	Notes
CI2	-	Set idle current to 2 amps
CC2	-	Set running current to 2 amps
CI	CI=1	CI automatically set to 1 amp to match 50% of CC2 command
CI1.8	-	Set idle current to 1.8 amps, or 90% of last CC value

## CJ - Commence Jogging

Compatibility: All drives  
 See also: JS, JA, JL, SJ, CS and DI commands.

Starts the motor jogging. The motor accelerates up to the jog speed (JS) at a rate defined by the jog accel (JA) command, then runs continuously until stopped. To stop jogging, use the SJ (Stop Jogging) command for a controlled decel rate (decel rate set by JL command). For a faster stop, use the ST command (decel rate set by AM command), but beware that if the speed or load inertia is high, the drive may miss steps, stall, or fault. The jogging direction is set by the last DI command. Use the CS command to change jog speed and direction while already jogging. CS does not affect JS.

### Use in Q Programs (Q drives only)

Within a stored Q program jog moves are most commonly initiated with the CJ command. However, because the SJ and ST commands are immediate type they cannot be used within a Q program to stop the jog move. So the procedure to stop a jog move within a Q program involves both the MT (Multi-tasking) and SM (Stop Move) commands. See Examples below for a sample command sequence.

### Command Details:

Structure	CJ
Type	BUFFERED
Usage	WRITE ONLY
Non-Volatile	NO
Register Access	None

### Examples:

Command	Drive sends	Notes
JA10	-	Set jog accel to 10 rps/s
JL25	-	Set jog decel to 25 rps/s
JS1	-	Set jog speed to 1 rps
CJ	-	Start jogging with speed set by last JS command
CS10	-	Change jog speed to 10 rps
SJ	-	Stop jogging using decel rate set by last JL command

The following example changes the jog speed during program execution by directly loading a value into the “J” register. This method allows for dynamically calculated jog speeds, and does not affect the original JS or DI setting. CJ always starts a jog move using JS and DI, so this is the recommended method of changing speed dynamically during program execution.

#### Sample Q program sequence

MT1	Turn Multi-tasking ON
FI58	Filter input X5 for 8 processor ticks (2 msec)
WIX5L	Wait for input X5 low
CJ	Commence jogging
RLJ480	Change speed to 2 rev/sec by directly loading the J register. Note, units are 0.25rpm.
WIX5H	Wait for input X5 high
SMD	Stop Move using the decel ramp set by JL



## CM - Command Mode (AKA Control Mode)

Compatibility: All drives  
 Affects: Drive mode of operation  
 See also: PM command

Sets or requests the Command Mode that the drive operates in. For more automated setup of command modes use the appropriate *Configurator* or *Quick Tuner* software application. The most common command mode is Point-to-Point (21), in which all move commands can be executed. Move commands (like FL, FP, FS, and CJ) can still be executed when the command mode is set to Step & Direction (7), because the drive will temporarily switch to command mode 21 to execute the move, then revert back to command mode 7 when the move is finished. However move commands are either ignored or do not function properly when the command mode is set to any velocity mode (11-18) or the Analog Position mode (22).

**WARNING:** *Changing the Command Mode without proper care may cause the motor to spin at a high rate of speed or give other unexpected results. For this reason it is suggested that the appropriate Configurator or Quick Tuner software application be used to test specific Command Modes first before changing them in the application using the CM command.*

### Command Details:

Structure	CM{Parameter #1}
Type	BUFFERED
Usage	READ/WRITE
Non-Volatile	YES
Register Access	"m" (061) Note: Because a drive can change Command Mode on it's own to complete certain moves, the CM command and the "m" register may not always match.

### Parameter Details:

Parameter #1	Command mode
- units	integer code
- range	1 - Commanded Torque (servo only) 2 - Analog Torque (servo only) 7 - Step & Direction 10 - Commanded Velocity (jog mode) 11 - Analog velocity 12 to 18 - (see below) 21 - Point-to-Point 22 - Analog Position

**NOTE:** *In Command Modes 11, 12, 13 and 14, input X2 will function to reverse the direction of motion.*

**For StepSERVO and SV200, additional command modes have been added for variations on analog torque control as well as expanded velocity modes. See appropriate software and help files for details.**

Command Modes 12 to 18 are for stepper drives and SV servo drives only:

- 12 - Analog velocity mode with input X1 as run/stop input
- 13 - Analog velocity mode with input X5 (X4 for STAC5 drives) as speed change input
- 14 - Analog velocity mode with input X1 as run/stop input and input X5 (X4 for STAC5 drives) as speed change input
- 15 - Velocity mode (JS for speed)
- 16 - Velocity mode (JS for speed) with input X1 as run/stop input
- 17 - Velocity mode (JS for speed) with input X5 (X4 for STAC5 drives) as speed change input
- 18 - Velocity mode (JS for speed) with input X1 as run/stop input and input X5 (X4 for STAC5 drives) as speed change input

*NOTE: It is recommended to use Configurator or Quick Tuner software for setting up velocity mode operation.*

### Examples:

Command	Drive sends	Notes
CM2	-	Sets the servo drive to Analog Torque mode, at which time there is a linear relationship between the voltage at the drive's analog input and the motor current.
CM7	-	Sets the drive to Step & Direction input mode, which is used for all digital positioning schemes like Step (Pulse) & Direction, CW/CCW Pulse, and A/B Quadrature. Use the appropriate Configurator or Quick Tuner application to set the proper scheme within this mode.
CM10	-	Sets the drive to Command Velocity, or jog mode, which in practice is very similar to Point-to-Point mode (CM21). When in CM21 and a jog command is issued, like CJ, the drive automatically switches to CM10 during the jog move and then back to CM21 when the jog move is stopped. Conversely, when in CM10 and a feed move is commanded, like FL, the drive automatically switches to CM21 during the move and then back to CM10 when the move is finished. CM10 is most useful with servo drives, and when the JM (Jog Mode) is set to 2. This puts the drive into a jog mode in which position error is ignored. Then, when the motor is at rest the drive acts somewhat like a constant friction device in that a certain amount of torque (set by CC and CP commands) is required to move the shaft.
CM11	-	Sets the drive to Analog Velocity mode. In servo drives this will be similar to the Analog Torque mode, where voltage level at the analog input relates to motor speed. In stepper drives this puts the drive into continuous oscillator mode, with speed set by the JS command.
CM22	-	Sets the drive to Analog Positioning mode. In this mode it is also possible to control the position through the use of an external encoder.

## CN - Secondary Control Mode

Compatibility: SV200 series servo drives only  
 Affects: All control mode  
 See also: CM, MS commands

Sets or requests the second command mode that the servo drive operates in. This command was first introduced on the SV200 series servo drives and is used to set a second, alternate command mode that can be triggered by changing the state of a specific digital input (X8 input for SV200 series). Primary command mode is set with CM. See SVX Servo Suite software and drive's hardware manual for details.

- 1 - Commanded Torque
- 2 - Analog Torque
- 3 - Analog Torque with Input X2 as direction input
- 4 - Analog Torque with Input X2 as direction input
- 5 - Analog Torque with Input X1 as start/stop input
- 6 - Analog Torque with Input X1&X2 as start/stop & direction input
- 7 - Step & Direction
- 8 - Analog Torque with Input X1&X2 as start/stop & direction input
- 10 - Commanded Velocity (jog mode)
- 11 - Analog velocity
- 12 - Analog velocity mode with input X1 as run/stop input
- 13 - Analog velocity mode with input X10 X11 X12 as speed change input
- 14 - Analog velocity mode with input X1 as run/stop input and input X10~X12 as speed change input
- 15 - Velocity mode (JS for speed)
- 16 - Velocity mode (JS for speed) with input X1 as run/stop input
- 17 - Velocity mode (JS for speed) with input X10~X12 as speed change input
- 18 - Velocity mode (JS for speed) with input X1 as run/stop input and input X10~X12 as speed change input
- 21 - Point-to-Point
- 22 - Analog Position

### Command Details:

Structure	CN{Parameter #1}
Type	BUFFERED
Usage	READ/WRITE
Non-Volatile	YES
Register Access	None

### Parameter Details:

Parameter #1	The second control mode
- units	Integer
- range	1~22
Default value	7

### Examples:

Command	Drive sends	Notes
CN7	%	Set the second control mode to Step & Direction
CN	CN=7	The second control mode is Step & Direction

## CO - Node ID/ IP address

Compatibility: SV200 series servo drives only  
 Affects: CANOpen drives & Ethernet drives

Sets or requests the CANOpen Node ID of CANOpen type drives or the Ethernet IP address of Ethernet type drives.

For the Ethernet type drives, the CO command sets the IP address which can be modified as necessary with SVX Servo Suite.

Default IP address list for Ethernet type drives:

0 – 10.10.10.10  
 1 – 192.168.1.10  
 2 – 192.168.1.20  
 3 – 192.168.1.30  
 4 – 192.168.0.40  
 5 – 192.168.0.50  
 6 – 192.168.0.60  
 7 – 192.168.0.70  
 8 – 192.168.0.80  
 9 – 192.168.0.90  
 10 – 192.168.0.100  
 11 – 192.168.0.110  
 12 – 192.168.0.120  
 13 – 192.168.0.130  
 14 – 192.168.0.140  
 15 – 0.0.0.0(DHCP)

### Command Details:

Structure	CO{Parameter #1}
Type	BUFFERED
Usage	READ/WRITE
Non-Volatile	YES
Register Access	None

### Parameter Details:

Parameter #1	Node ID of CANOpen type drives or the IP address of Ethernet type drives
- units	Integer
- range	For CANOpen type drives 1~127 For Ethernet type drives 0~15
Default value	For CANOpen type drives 1 For Ethernet type drives 0

### Examples:

Command	Drive sends	Notes
CO1	%	Set the node ID to 1 of CANOpen drive or set the IP address to 192.168.1.10 (default IP Address list)
CO	CN=7	The node ID of CANOpen drive is 1 or the IP address of Ethernet drive is 192.168.1.10 (default IP Address list)

## CP - Change Peak Current

**Compatibility:** Servo drives only  
**Affects:** Motor current, especially during acceleration and deceleration  
**See also:** CC, PC, PP commands

Sets or requests the peak (RMS) current setting of the servo drive. Peak current sets the maximum current that should be used with a given motor. When the motor position requires more than the continuous value, the peak current time calculation is done using  $I^2/T$  which integrates current values for more accurate modeling of drive and motor heating. The servo drive will allow peak current for no more than one second. After one second of operation at peak current the current is reduced to the continuous current setting (see CC command).

### Command Details:

Structure	CP{Parameter #1}
Type	BUFFERED
Usage	READ/WRITE
Non-Volatile	YES
Register Access	“O” (031) Note: The CP command uses different units than the “O” register; see Data Registers section for more details

### Parameter Details:

Parameter #1	Peak current limit
- units	amps RMS
- range	BLuDC4: 0 - 13.5 A BLuDC9: 0 - 18.0 A BLuAC5: 0 - 15.0 A SV7: 0 - 14.0 A SVAC3 (120V): 0 - 7.5 SVAC3 (220V): 0 - 3.75 Note: For StepSERVO and SV200 series, see hardware manual for peak current range.

### Examples:

Command	Drive sends	Notes
CP9.0	-	Peak current is set to 9.0 amps RMS
CP	CP=9.0	

## CR - Compare Registers

Compatibility: Q drives only  
 Affects: Contents of condition code register “h”  
 See also: RI, RD, RM, RL, QJ commands

Compare the contents of two data registers. The first data register (Parameter #1) is tested by comparing it against the data value in the second data register (Parameter #2). The result is a condition code that can be used for program conditional processing (see QJ command). For Example, if the first data register is greater than the second the “greater than” flag is set and the QJGx command can be used to create a conditional jump.

### Command Details:

Structure	CR(Parameter #1)(Parameter #2)
Type	BUFFERED
Usage	WRITE ONLY
Non-Volatile	NO
Register Access	All data registers

### Parameter Details:

Parameter #1	First data register assignment
- units	character
- range	All data register assignments
Parameter #2	Second data register assignment
- units	character
- range	All data register assignments

### Examples:

Command	Drive sends	Notes
CRE1	-	Compare data register “E” to data register “1”
QJG5	-	If “E” register is greater than “1” register jump to line 5 of Q segment, otherwise proceed to next line.

## CS - Change Speed

Compatibility: All drives  
 Affects: Jog speed while jogging  
 See also: CJ, JS, JA, JL commands

Sets or requests the jogging speed in rev/sec while jogging. When Jogging using the CJ command the Jog speed can be changed dynamically by using this command. The sign of CS can be positive or negative allowing the direction of jogging to be changed dynamically also. Ramping between speeds is controlled by the JA and JL commands. Setting CS does not change JS or DI.

### Command Details:

Structure	CS{Parameter #1}
Type	IMMEDIATE
Usage	READ/WRITE
Non-Volatile	YES
Register Access	“J” (026) Note: The CS command uses different units than the “J” register; see Data Registers section for more details.

### Parameter Details:

Parameter #1	Jog Speed
- units	rev/sec
- range	BLu, SV, STAC6, ST-Q/Si, ST-S, STAC5, SVAC3: -133.3333 to 133.3333 (resolution is 0.0042) STM: -80.0000 to 80.0000 (resolution is 0.0042) sign determines direction: “-“ for CCW, no sign for CW

### Examples:

Command	Drive sends	Notes
JS1	-	Set base jog speed to 1 rev/sec
CJ	-	Commence jogging
CS2.5	-	Set jog speed to CW at 2.5 rev/sec
CS	CS=2.5	Displays current Jog speed
CS-5	-	Set jog speed to CCW at 5 rev/sec
SJ	-	Stop jogging

---

## CT - Continue

---

Compatibility: All drives  
 See also: PS, ST, SK commands

Resume execution of buffered commands after a PS command has been sent. The PS (Pause) command allows you to pause execution of commands in the command buffer. After sending the PS command, subsequent commands are buffered in the command buffer until either a CT command is sent, at which time the buffered commands resume execution in the order they were received, or until the command buffer is full.

### Command Details:

Structure	CT
Type	IMMEDIATE
Usage	WRITE ONLY
Non-Volatile	NO
Register Access	None

### Examples:

Command	Drive sends	Notes
PS	-	Pause command buffer
FL2000	-	CW move, 2000 counts
WT.25	-	Wait 0.25 seconds
FL-2000	-	CCW move, 2000 counts
CT	-	Resume execution of buffered commands



## DA - Define Address

Compatibility: All drives  
 Affects: Drive address for multi-drop communications

Sets individual drive address character for multi-drop RS-485 communications. This command is not required for single-axis (point-to-point) or RS-232 communications.

### Command Details:

Structure	DA{Parameter #1}
Type	BUFFERED
Usage	READ/WRITE
Non-Volatile	YES
Register Access	None

### Parameter Details:

Parameter #1	RS-485 network address
- units	character
- range	Valid address characters are: !"#\$%&'()*+,-./0123456789:;<>?@

### Examples:

Command	Drive sends	Notes
DA1	-	Set drive address to "1"
DA	DA=1	

## DC - Change Distance

Compatibility: All drives  
 Affects: FC, FY, FO, FM commands.

Sets or requests the change distance. The change distance is used by various move commands to define more than one distance parameter. All move commands use the DI command at some level, and many require DC as well. Examples are FC, FM, FO, and FY. The moves executed by these commands change their behavior after the change distance (DC) has been traveled. For example, FM is similar to FS, but in an FM move the sensor input is ignored until the motor has moved the number of steps set by DC. This is useful for masking unwanted switch or sensor triggers. Since DI sets move direction (CW or CCW), the sign of DC is ignored.

### Command Details:

Structure	DC{Parameter #1}
Type	BUFFERED
Usage	READ/WRITE
Non-Volatile	YES
Register Access	"C" (019)

### Parameter Details:

Parameter #1	distance
- units	encoder counts
- range	0 to 2,147,483,647 (the sign of negative values is ignored)

### Examples:

Command	Drive sends	Notes
DC80000	-	Set change distance to 80000 counts
DC	DC=80000	
DI-100000	-	Set overall move distance to 100000 counts in CCW direction
DC50000	-	Set change distance to 50000 counts
VE5	-	Set base move velocity to 5 rev/sec
VC2	-	Set change velocity to 2 rev/sec
FC	-	Initiate FC command

## DD - Default Display Item of LEDs

Compatibility: SV200 servo drives only  
 Affects: LED display

Sets or requests the default monitor item for the drive's LED display after power up.  
 The item is defined as belows:

0	Velocity
1	Position Error
2	StepPosition
3	Encoder Position
4	Position Command
5	Temperature
6	DC_Bus_Voltage
7	Address
8	Alarm History 0
9	Alarm History 1
10	Alarm History 2
11	Alarm History 3
12	Alarm History 4
13	Alarm History 5
14	Alarm History 6
15	Alarm History 7

### Command Details:

Structure	DD{Parameter #1}
Type	IMMEDIATE
Usage	READ/WRITE
Non-Volatile	Yes
Register Access	None

### Parameter Details:

Parameter #1	Default display item of LEDs
- units	Integer
- range	0~15
Default value	0

### Examples:

Command	Drive sends	Notes
DD0	%	Set the default display item to immediate velocity
DD	DD=0	The default display item is immediate velocity

## DE - Deceleration

Compatibility: All drives  
 Affects: FC, FD, FE, FL, FM, FO, FS, FP, FY, SH commands  
 See also: AM, DE, DI, DC, VE commands

Sets or requests the deceleration rate used in point-to-point move commands in rev/sec/sec.

### Command Details:

Structure	DE{Parameter #1}
Type	BUFFERED
Usage	READ/WRITE
Non-Volatile	YES
Register Access	“B” (018) Note: The DE command uses different units than the “B” register; see Data Registers section for details

### Parameter Details:

Parameter #1	Deceleration rate
- units	rev/sec/sec (rps/s)
- range	0.167 to 5461.167 (resolution is 0.167 rps/s)

### Examples:

Command	Drive sends	Notes
DE125	-	Set deceleration rate to 125 rev/sec/sec
DE	DE=125	

## DI - Distance/Position

Compatibility: All drives  
 Affects: All move commands  
 See also: AC, DC, DE and VE commands

Sets or requests the move distance in encoder counts (servo) or steps (stepper). The sign of DI indicates move direction: no sign means CW and "-" means CCW. DI sets both the distance for relative moves, like FL, and the position for absolute moves, like FP. DI also sets the direction of rotation for jogging (CJ).

### Command Details:

Structure	DI{Parameter #1}
Type	BUFFERED
Usage	READ/WRITE
Non-Volatile	YES
Register Access	"D" (020)

### Parameter Details:

Parameter #1	distance
- units	encoder counts (servo) or steps (stepper)
- range	-2,147,483,647 to 2,147,483,647 sign determines direction: "-" for CCW, no sign for CW

### Examples:

Command	Drive sends	Notes
DI20000	-	Set distance to 20000 counts in the CW direction
DI	DI=20000	
DI-8000	-	Set distance to 8000 counts in the CCW direction
FL	-	Initiate FL move

---

## DL - Define Limits

---

Compatibility: All drives  
Affects: All move commands  
See also: AM command

CW and CCW end-of-travel limits are available on all drives and can be used to define the boundaries of acceptable motion in a motor/drive system. If one of these inputs is activated while defined as an end-of-travel limit, motor rotation will stop in that direction, and an alarm code will show at the drive's status LEDs. When used within a Q program with point-to-point position commands (FL, FP, etc.), limit switch actuation will stop the motion that is specified by the Q program and then the program will drop down to the next line. When defining these inputs as end-of-travel limits both inputs are defined together as either active low, active high, or not used, except for StepSERVO series and SV200 series servo drives. See below for details.

**Note that when used in conjunction with jogging commands within a Q program, the ability to jog off a limit in the opposite direction may be limited.**

### BLu-S/Q, STAC6

Defines usage of inputs X6 and X7 as dedicated end-of-travel limits. X6 is the CCW limit input and X7 is the CW limit input. If not needed, X6 and X7 can be redefined as general purpose inputs.

### STAC5-S, SVAC3-S

Defines usage of inputs X1 and X2 as dedicated end-of-travel limits. X1 is the CW limit input and X2 is the CCW limit input. If not needed, X1 and X2 can be redefined as general purpose inputs.

### STAC5-Q/IP, SVAC3-Q/IP

Defines usage of inputs IN7 and IN8 as dedicated end-of-travel limits. IN7 is the CW limit input and IN8 is the CCW limit input. If not needed, IN7 and IN8 can be redefined as general purpose inputs.

### Blu-Si

Defines usage of top-board inputs IN7 and IN8 as dedicated end-of-travel limits. IN7 is the CW limit input and IN8 is the CCW limit input.

### ST-Q/Si, SV

Defines the usage of inputs X7 and X8 as dedicated end-of-travel limits. X7 is the CW limit input and X8 is the CCW limit input. If not needed, X7 and X8 can be redefined as general purpose inputs.

### ST-S, STM-17/23

Defines the STEP and DIR inputs as CW end-of-travel and CCW end-of-travel limit inputs, respectively. The STEP and DIR inputs can each be assigned to only one function in an application. If you want to use the STEP and DIR inputs as end-of-travel limit inputs you can define them as such in two ways, with the *ST Configurator* software, or with the DL command. DL takes no effect if the drive is set in Command Mode (CM) 7, 11, 12, 13, 14, 15, 16, 17 or 18, because these modes predefine these inputs and take precedence over the DL command. Also, setting the JE command after setting the DL command reassigns the STEP and DIR inputs as jog inputs and turns off any limit input usage (DL3). In other words, the DL and JE commands, as well as Command Modes (CM) 7, 11, 12, 13, 14, 15, 16, 17 and 18 each assign a usage to the STEP and DIR inputs. Each of these must exclusively use the STEP and DIR inputs. Command Modes are most dominant and will continually prevent DL and JE from using the inputs. DL and JE exclude each other by overwriting the usage of the STEP and DIR inputs.

### STM24-C

Defines the usage of inputs IN1 and IN2 as dedicated end-of-travel limits. IN1 is the CW limit input and IN2 is the CCW limit input. If not needed, IN1 and IN2 can be redefined as general purpose inputs.

## STM24-SF/QF

Drives with Flex I/O allow a user to configure a drives I/O (I/O1 through I/O4) to be either an input or an output by using the SD command. For the DL command, the drive uses inputs I/O3 and I/O4 as dedicated end-of-travel limits. I/O3 is the CW limit input and I/O4 is the CCW limit input. If not needed, I/O3 and I/O4 can be redefined as general purpose inputs.

There are three end-of-travel limit input states that can be defined with the DL command:

- DL1: End-of-travel limit occurs when an input is closed (energized). Motion stops automatically at rate defined by AM command.
- DL2: End-of-travel limit occurs when an input is open (de-energized). Motion stops automatically at rated defined by AM command.
- DL3: Inputs are not used as end-of-travel limit inputs and can be used as a general purpose inputs. In the case of ST-S and STM drives, DL will be automatically set to 3 if CM is set to 7, 11, 12, 13, 14, 15, 16, 17, or 18, or if JE is executed after the DL command is set.

## Command Details:

Structure	DL{Parameter #1}
Type	BUFFERED
Usage	READ/WRITE
Non-Volatile	YES
Register Access	None

## Parameter Details:

Parameter #1	Limit input state (see above)
- units	integer number
- range	1, 2 or 3

## Examples:

Command	Drive sends	Notes
DL1	-	Set limit inputs to work with normally open limit switches
DL	DL=1	
DL3	-	Set limit inputs to act as general purpose inputs

*NOTE: When working with digital inputs and outputs it is important to remember the designations **low** and **high**. If current is flowing into or out of an input or output, i.e. the circuit is energized, the logic state for that input/output is defined as **low** or closed. If no current is flowing, i.e. the circuit is de-energized, or the input/output is not connected, the logic state is **high** or open. A low state is represented by the "L" character in parameters of commands that affect inputs/outputs. For example, WI3L means "wait for input 3 low", and SO1L means "set output 1 low". A high state is represented by the "H" character.*

## DL - Define Limits (StepSERVO and SV200 drives)

Compatibility: SSM, TSM, TXM, SS, SSAC and SV200 drives

Affects: All move commands

See also: AM, EH, FH, SH commands

CW and CCW end-of-travel limits are available on all drives and can be used to define the boundaries of acceptable motion in a motor/drive system. If one of these inputs is activated while defined as an end-of-travel limit, motor rotation will stop in that direction, and an alarm code will show at the drive's status LEDs. When defining these inputs as end-of-travel limits, individual or both inputs can be defined as either active low, active high, or not used. See below for details.

DL1: End-of-travel limit occurs when an input is closed (energized). Motion stops automatically at rate defined by AM command.

DL2: End-of-travel limit occurs when an input is open (de-energized). Motion stops automatically at rate defined by AM command.

DL3: Inputs are not used as end-of-travel limit inputs and can be used as a general purpose inputs. In the case of ST-S and STM drives, DL will be automatically set to 3 if CM is set to 7, 11, 12, 13, 14, 15, 16, 17, or 18, or if JE is executed after the DL command is set.

DL7: individually set end-of-travel in CW direction when CW Limit inputs is closed(energized).

DL8: individually set end-of-travel in CW direction when CW Limit inputs is open (de-energized).

DL9: individually set end-of-travel in CCW direction when CCW Limit inputs is closed(energized).

DL10: individually set end-of-travel in CCW direction when CCW Limit inputs is open (de-energized).

DL11~13, DL17~20: Swap the CW input and CCW input definition as above setting.

### Command Details:

Structure	DL{Parameter #1}
Type	BUFFERED
Usage	READ/WRITE
Non-Volatile	YES
Register Access	None

### Parameter Details:

Parameter #1	Limit input state (see above)
- units	integer number
- range	1 to 20

### Examples:

Command Drive sends Notes

DL1 - Set limit inputs to work with normally open limit switches

DL DL=1

DL3 - Set limit inputs to act as general purpose inputs

*NOTE: When working with digital inputs and outputs it is important to remember the designations low and high. If current is flowing into or out of an input or output, i.e. the circuit is energized, the logic state for that input/output is defined as low or closed. If no current is flowing, i.e. the circuit is de-energized, or the input/output is not connected, the logic state is high or open. A low state is represented by the "L" character in parameters of commands that affect inputs/outputs. For example, W13L means "wait for input 3 low", and SO1L means "set output 1 low". A high state is represented by the "H" character.*



## DR - Data Register for Capture

Compatibility: Q servo drives only (BLu-Q and SV-Q)  
 Affects: Quick Tuner Data Capture

Sets or requests the data register used in the register plot data source in Quick Tuner. Any data register can be selected for viewing when capturing data using Quick Tuner.

### Command Details:

Command Type	BUFFERED
Usage	WRITE ONLY
Non-Volatile	NO
Register Access	All data registers

### Parameter Details:

Parameter #1	Data register assignment
- units	character
- range	All data register assignments

### Examples:

Command	Drive sends	Notes
DRa	-	Set capture data register to "a" (Analog Command) register

## DS - Switching Electronic Gearing

Compatibility: SV200 series servo drives only  
 Affects: control mode 7, electronic gearing, input #9  
 See also: EG, PV, EU, EN

Defines the usage of input X9 as electronic gearing selection.  
 DS1: EG is selected when input X9 is open, and PV is selected when input X9 is closed.  
 DS2: EG is selected when input X9 is closed, and PV is selected when input X9 is open.  
 DS3: Input X9 is used as general purpose input. And EG is selected.

### Command Details:

Structure	DS{Parameter #1}
Type	BUFFERED
Usage	READ/WRITE
Non-Volatile	YES
Register Access	None

### Parameter Details:

Parameter #1	(see above)
- units	integer number
- range	1 ~ 3
Default value	3

### Examples:

Command	Drive sends	Notes
DS1	%	set the usage of electronic gearing selecting to 1
DS	DS=1	set the usage of input X9 as electronic gearing selecting is 1

## ED - Encoder Direction

Compatibility: BLu, STAC5, STAC6, SV7, SVAC3  
 Affects: Encoder count direction  
 See also: EF, EI commands

### BLu, STAC5, STAC6, SV7, SVAC3

Sets or requests the encoder count direction.

### Command Details:

Structure	ED {Parameter #1}
Type	BUFFERED
Usage	READ/WRITE
Non-Volatile	YES
Register Access	none

### Parameter Details:

Parameter #1	Encoder Count Direction
- units	Binary flag (0 or 1)
- range	0 = default behavior 1 = count in reverse

### Examples:

Command	Drive sends	Notes
ED1	-	Set encoder to count in reverse
ED	ED=1	

## EF - Encoder Function

Compatibility: Stepper drives with encoder feedback  
 Affects: Stall Detection and Stall Prevention  
 See also: CC, CI, ER, HD, PF commands

*NOTE: The behavior of this function was updated subsequent to firmware rev 1.04L (STM17, 23). Most notably, a power-cycle was required to initialize the drive with a new EF setting. Drives with more recent firmware perform a current probe and encoder alignment immediately following execution of the EF command, and do not require the drive to be reset. All descriptions shown here assume that the drive is running current firmware.*

### ST-Q/Si, STM

Sets or requests the decimal equivalent of the encoder function's 3-bit word. The encoder function can be set through Configurator or by using the EF command. Only stepper drives with encoder inputs (optional on ST-Q/Si, STAC5 and STM drives) running a step motor with a shaft-mounted encoder can utilize the Stall Detection and Stall Prevention functions. Note, this feature is NOT available on the STAC6.

AMP recommends an encoder with differential outputs and a resolution of at least 1000 lines (4000 counts/rev).

EF0: Disable Encoder Functionality  
 EF1: Turn Stall Detection ON.  
 EF2: Turn Stall Prevention ON.  
 EF6: Turn Stall Prevention with time-out ON.

The drive performs a full current probe for encoder alignment during power-up and after each EF command is sent. It is very important to raise the idle and continuous current settings to the maximum value and then execute the new EF setting after a 1 second delay. Once the EF command is completed, the current may be reset to its normal value.

### Command Details:

Structure	EF{Parameter #1}
Type	BUFFERED
Usage	READ/WRITE
Non-Volatile	YES
Register Access	None

### Parameter Details:

Parameter #1	Encoder function setting
- units	decimal equivalent of 3-bit binary word
- range	0 = Encoder function off 1 = Stall Detection 2 = Stall Prevention 6 = Stall Prevention with time-out

## Examples:

Command	Drive sends	Notes
EF1	-	Turn ON Stall Detection function
EF	EF=1	
EF6	-	Enable Stall Prevention with time-out
EF	EF=6	

Example encoder alignment sequence (STM24):

CC6	Raise current to 6A
CI5.4	Raise idle current to 5.4A*
EF1	Enable Stall Detection feature
CC3	Lower current to normal running level (application dependent)
CI2.4	Lower idle current to normal running level (application dependent)

If this is done through a Q program, add a short delay after raising current levels:

CC6	Raise current to 6A
CI5.4	Raise idle current to 5.4A*
WT1	Short delay
EF1	Enable Stall Detection feature
CC3	Lower current to normal running level (application dependent)
CI2.4	Lower idle current to normal running level (application dependent)

\* 90% of CC; see CI command for details

## EG - Electronic Gearing

Compatibility: All drives  
 Affects: Command Mode 7, FE and HW commands  
 See also: CM, ER, FE and HW commands.

### BLu, SV

Sets or requests the pulses per revolution for electronic gearing. For example, with an EG value of 20000 the servo drive will require 20000 pulses from the master pulse source to move the servo motor 1 revolution.

### STAC6, ST-Q/Si, ST-S, STM

Sets or requests the desired step/microstep resolution of the step motor.

### Command Details:

Structure	EG{Parameter #1}
Type	BUFFERED
Usage	READ/WRITE
Non-Volatile	YES
Register Access	"R" (034) Note: With servo drives the EG command is equal to the "R" register. With stepper drives the EG command is equal to twice the "R" register.
Parameter #1	Servo = electronic gearing ratio Stepper = step resolution
- units	Servo = counts/rev Stepper = steps/rev
- range	Servo = 200 - 32000 Stepper = 200 - 51200

### Examples:

Command	Drive sends	Notes
EG20000	-	Set electronic gearing resolution in servo drive to 20000 pulses/rev
EG	EG=20000	
RLR	RLR=20000	"R" register matches the EG setting in a servo drive
EG36000	-	Set microstep resolution to 36000 steps/rev in a stepper drive
EG	EG=36000	
RLR	RLR=18000 steps/rev	"R" register contains 1/2 the EG setting in a stepper drive, or 18000

## EH - Extended Homing

Compatibility: SSM, TSM, TXM, SS, SSAC and SV200 series servo drives only  
 See also: DL, HA, HL, HV, HO commands

Executes the Extended Homing process. Requires input number and condition for the home sensor. Speeds for each step are set by HV command, there are three velocity settings; one for each step (see graphic and examples below). Acceleration and deceleration are set by HA (Homing Accel) and HL (Homing Decel). The start direction comes from the sign of the HO command ("- is CCW, no sign is CW).

HV1: Homing velocity when searching for Limit Sensor and Home sensor.

HV2: Homing velocity when moving the offset distance after home sensor has been reached.

HV3: Homing velocity when returning back to home sensor after offset move.

HO: distance to move after home sensor is initially reached.

Here are examples of the Extended Homing process for different starting positions.

Condition: HO = 20000(no sign for CW direction) , DL = 2 (end-of-travel limit triggered when input is open)

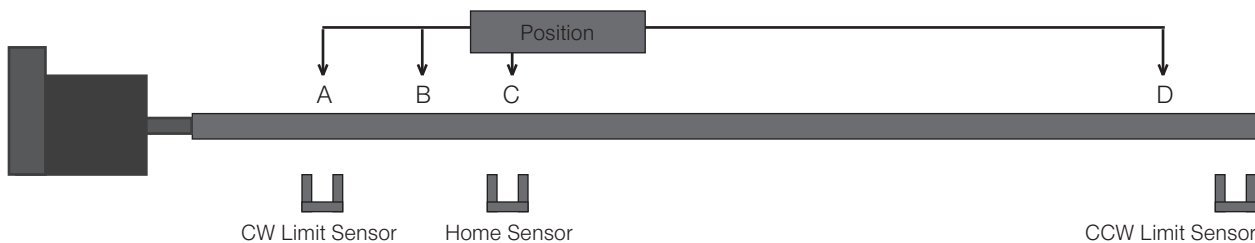

(1) When the motor is positioned at A (CW Limit Sensor triggered)

-The motor searches for the home sensor at the speed specified by HV1 value, with HA1/HL1 for acceleration/deceleration. Once home sensor is reached, it will move to the distance specified by HO value with HV2 speed and HA2/HL2 acceleration/deceleration beyond home sensor in CCW direction. Finally, the motor returns back to the home sensor position at the HV3 speed and HA3/HL3 acceleration/deceleration.

(2) When the motor is positioned at B (between CW Limit Sensor and Home Sensor)

-The motor moves in the CW direction to find CW limit sensor with HV1 speed and HA1/HL1 acceleration/deceleration.

-The CW limit sensor triggered and motion stops briefly.

-Then the motor moves the same as above (1).

(3) When the motor is positioned at C (Home Sensor triggered)

-The motor moves to the distance specified by HO value with HV2 speed and HA2/HL2 acceleration/deceleration beyond home sensor in CCW direction. Finally, the motor returns back to the home sensor position at the HV3 speed and HA3/HL3 acceleration/deceleration.

(4) When the motor is positioned at D (between Home Sensor and CCW Limit Sensor)

-The motor moves to home sensor with speed HV1 in CW direction.

-After Home Sensor triggered, The motor moves the same as above (3)

**NOTE: If the HO value is negative, the motor will start in the CCW direction.**

*NOTE: This command is designed for use with three physical sensors or switches tied to three separate digital inputs of the drive: a home sensor, a CW end-of-travel limit, and a CCW end-of-travel limit.*

### Command Details:

Structure	EH{Parameter #1}
Type	BUFFERED
Usage	WRITE ONLY
Non-Volatile	No
Register Access	None

### Parameter Details:

Parameter #1	Input number, Input condition
- units	Integer, letter
- range	Integer: Input number (range depends on model) letter: L = low, H = high, F = falling edge, R = rising edge

### Examples:

Command	Drive sends	Notes
EH3L	%	Homing to home sensor wired to input 3, triggered by Low (closed circuit) condition



## EI - Input Noise Filter

Compatibility: ST, STM, SV7, SVAC3, STAC5 and STAC6  
 Affects: "Input Noise Filter" parameter  
 See also: CM, ER, FE and HW commands.

Sets or requests the Input Noise Filter parameter. This parameter acts as a low-pass filter, rejecting noise above the specified frequency.

*NOTE: On STAC5-S and SVAC3-S drives, this parameter setting affects inputs X1 - X4, and is an alternative to the FI command if input noise filtering is required.*

### STM17

Given a cutoff frequency, an appropriate EI value may be calculated as follows (where 'f' is the target cutoff frequency):

$$EI = 9,000,000 / f$$

### ST, STM23 / 24, SV7, SVAC3, STAC5, STAC6

Given a cutoff frequency, an appropriate EI value may be calculated as follows (where 'f' is the target cutoff frequency):

$$EI = 15,000,000 / f$$

## Command Details:

Structure	EI {Parameter #1}
Type	BUFFERED
Usage	READ/WRITE
Non-Volatile	YES
Register Access	none

## Parameter Details:

Parameter #1	Noise Filter Constant
- units	
- range	0 - 255

## Examples:

Command	Drive sends	Notes
EI128	-	(STM17) Set noise filter to 70.3 kHz (9,000,000 / 128)
EI128	-	(STM23) Set noise filter to 117.2 kHz (15,000,000 / 128)
EI	EI=128	

## EN - Numerator of Electronic Gearing Ratio

Compatibility: SV200 series servo drives only  
 Affects: control mode 7, electronic gearing  
 See also: EG, PV, EU DS commands.

Defines the numerator of electronic gearing ratio.  
 0 – do not use the electronic gearing ratio.

### Command Details:

Structure	EN{Parameter #1}
Type	BUFFERED
Usage	READ/WRITE
Non-Volatile	YES
Register Access	None

### Parameter Details:

Parameter #1	numerator of electronic gearing
- units	integer number
- range	0 - 1000
Default value	1000

### Examples:

Command	Drive sends	Notes
EN1000	%	Set the numerator of electronic gearing ratio to 1000
EN	EN=1000	the numerator of electronic gearing ratio is 1000

## EP - Encoder Position

Compatibility: Servo drives and stepper drives with encoder feedback  
 Affects: Encoder position value  
 See also: SP, MT, WM commands.

The EP command allows the host to define the present encoder position. For example, if the encoder is at 4500 counts, and you would like to refer to this position as 0, send EP0. To ensure that the internal position counter resets properly, use SP immediately following EP. For example, to set the position to zero after a homing routine, send EP0 then SP0.

Sending EP with no position parameter requests the present encoder position from the drive.

For best results when using stepper systems, AMP recommends setting both CC and CI to the motor's maximum ratings before issuing an EP command. This will avoid any position error caused by the motor's detent torque. Once EP has been changed, reset CC and CI to their running levels.

**WARNING: When in Multi-tasking mode (see MT command), the EP command should not be issued while the drive is simultaneously executing a move command (CJ, FL, FP, FS, etc.). A drive fault or other unexpected problems may result.**

### Command Details:

Structure	EP{Parameter #1}
Type	BUFFERED
Usage	READ/WRITE
Non-Volatile	NO
Register Access	"e" (053) read only

### Parameter Details:

Parameter #1	Encoder position value
- units	Counts
- range	-2,147,483,647 to 2,147,483,647

### Examples:

Command	Drive sends	Notes
EP0	-	(Step 1) reset internal position counter
SP0	-	(Step 2) reset internal position counter

## ER - Encoder Resolution

Compatibility: Servo drives and stepper drives with encoder feedback  
 Affects: Motor Operation

Sets the encoder resolution in quadrature counts. For example, if the motor connected to the drive has an 8000 count (2000 line) per revolution encoder, set the encoder resolution to 8000.

**WARNING: Changing this setting will affect motor commutation with servo drives. Use the Quick Tuner (for BLu, SV7, and SVAC3 drives) setup utility to change this setting, then run the “Timing Wizard” in Quick Tuner to properly set up the motor commutation. (for BLu, SV7, and SVAC3 drives)**

### Command Details:

Structure	ER{Parameter #1}
Type	BUFFERED
Usage	READ/WRITE
Non-Volatile	YES
Register Access	None

### Parameter Details:

Parameter #1	Encoder resolution
- units	encoder counts/rev
- range	200 - 128000

### Examples:

Command	Drive sends	Notes
ER8000	-	Set encoder resolution to 8000 counts/rev
ER	ER=8000	

## ES - Single-Ended Encoder Usage

Compatibility: Servo and stepper drives with encoder feedback (except STM)

Allow a single-ended encoder to be used for drive feedback and commutation. This command has the same function as the box marked "Single Ended" in the Encoder setup screens of ST Configurator or QuickTuner.

While some applications require single-ended encoders to be used, differential signals are always recommended due to their superior noise immunity,

### Command Details:

Structure	ES{Parameter #1}
Type	BUFFERED
Usage	READ/WRITE
Non-Volatile	YES
Register Access	None

### Parameter Details:

Parameter #1	Single Ended Encoder Usage Flag
- units	integer
- range	0 = Differential encoder used (recommended) 1 = Single-ended encoder used

### Examples:

Command	Drive sends	Notes
ES0	-	Drive will use a differential encoder
ES	ES=0	
ES1	-	Drive will use a single-ended encoder
ES	ES=1	

## EU - Denominator of Electronic Gearing Ratio

Compatibility: SV200 series servo drives only  
 Affects: control mode 7, electronic gearing  
 See also: EG, PV, EN, DS commands.

Defines the denominator of electronic gearing ratio.  
 0 – do not use the electronic gearing ratio.

### Command Details:

Structure	EU{Parameter #1}
Type	BUFFERED
Usage	READ/WRITE
Non-Volatile	YES
Register Access	None

### Parameter Details:

Parameter #1	Denominator of electronic gearing
- units	integer number
- range	0 - 1000
Default value	1000

### Examples:

Command	Drive sends	Notes
EU1000	%	Set the denominator of electronic gearing ratio to 1000
EU	EN=1000	the denominator of electronic gearing ratio is 1000

## FA - Function of the Single-ended Analog Input

Compatibility: SV200 series servo drives only  
 Affects: Control mode relating to analog input  
 See also: CM, CN commands

Defines the function of the single-ended analog input.

The command has two parameters: the first parameter selects the analog channel; the second parameter sets the function of the selected analog channel.

1 – select analog channel 1

2 – select analog channel 2

eg:

FA11 Analog input Ain1 is used as velocity or position reference input.

FA12 Not used.

FA13: Analog input Ain1 is used as general purpose analog input.

FA21 Not used.

FA22 Analog input Ain2 is used as torque reference input.

FA23: Analog input Ain2 is used as general purpose analog input.

### Command Details:

Structure	FA{Parameter #1}{Parameter #2}
Type	BUFFERED
Usage	READ/WRITE
Non-Volatile	YES
Register Access	NO

### Parameter Details:

Parameter #1	Single-ended analog input channel
- units	integer number
- range	1~2
Parameter #2	Function of the selected analog channel
- units	integer number
- range	1~3
Default value	3

### Examples:

Command	Drive sends	Notes
FA11	%	Set the Analog input Ain1 to be used as velocity or position reference input.
FA1	FA1=1	The Analog input Ain1 is used as velocity or position reference input.

## FC - Feed to Length with Speed Change

Compatibility: All drives, though Q drives have added functionality (see below)  
 See also: VC, VE, DC, DI, SD, WP commands

Executes a feed to length (relative move) with a speed change. Overall move distance and direction come from the last DI command. Accel and decel are from AC and DE commands, respectively. Initial speed is VE. After the motor has moved DC counts, the speed changes to VC. If DC is equal to or greater than DI, a speed change will not occur.

Optionally, a parameter pair may be used with the FC command to designate a switch and polarity to use as a trigger for the final move segment. If a switch parameter is used, the motor will change speed at the DC distance and will maintain that speed until the input is triggered. Once this input condition is met, the drive will travel the full DI distance and decelerate to a stop per the DE ramp. In this scenario, the overall move distance is the sum of DC, DI and the distance between the DC change point and the point where the input is triggered. The overall distance then, depends on the location of the trigger input.

### Q drives only

With Q drives there may be multiple VCs and DCs per FC command, allowing for more complex, multi-velocity moves. To make multi-velocity moves with more than one speed change, the WP (Wait Position) command is also required. A sample sequence is shown in the Examples section below.

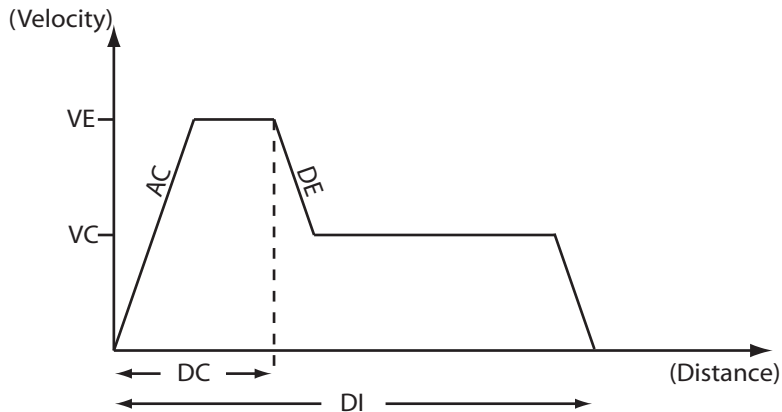

FC used without optional parameter

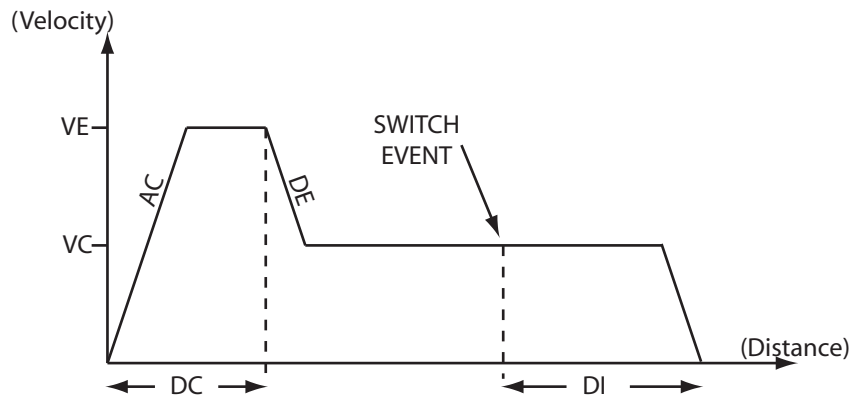

FC used with optional parameter



## Command Details:

Structure	FC{Parameter #1}{Parameter #2}
Type	BUFFERED
Usage	WRITE ONLY
Non-Volatile	NO
Register Access	None

## Parameter Details:

(See Appendix F: Working With Inputs and Outputs)

### Examples:

Command	Drive sends	Notes
DI50000	-	Set distance to 50000 steps
VE5	-	Set velocity to 5 rps
DC40000	-	Set change distance to 40000 steps
VC0.5	-	Set change velocity to 0.5 rps
FC	-	Initiate move
<i>FC with I/O trigger</i>		
DI50000	-	Set distance to 50000 steps
VE5	-	Set velocity to 5 rps
DC40000	-	Set change distance to 40000 steps
VC0.5	-	Set change velocity to 0.5 rps
FC1L	-	Initiate move, specifying that the drive will move 50000 steps beyond the point where input 1 goes LOW.

### *For Q drives only*

MT1	-	Turn multi-tasking ON*
DI50000	-	Set overall move distance to 50000 steps
VE5	-	Set initial velocity to 5 rps
DC10000	-	Set 1st change distance to 10000 steps
VC10	-	Set 1st change velocity to 10 rps
FC	-	Initiate move
WP	-	Wait position
DC20000	-	Set 2nd change distance to 20000 steps
VC1	-	Set 2nd change velocity to 1 rps
WP	-	Wait position
DC30000	-	Set 3rd change distance to 30000 steps
VC0.5	-	Set 3rd change velocity to 0.5 rps

\* Because multi-tasking is required for the WP command to be used, only Q models can perform multi-segment moves.

## FD - Feed to Double Sensor

Compatibility: All drives

See also: FM, FS, FY, VC commands; see AT command for using analog input as sensor input

Accelerates the motor at rate AC to speed VE. When the first sensor is reached (first input condition is made), the motor decelerates at rate DE to speed VC. When the second sensor is reached (second input condition is made), the motor decelerates over the distance DI to a stop at rate DE. The sign of the DI register is used to determine both the direction of the move (CW or CCW), and the distance past the second sensor. If DI is long the motor may not begin decel immediately after the second sensor. If DI is short the motor may decelerate using a faster decel rate than DE. Both analog and digital inputs can be used as sensor inputs.

### BLu, STAC6, STAC5-Q/IP, SVAC3-Q/IP, STM

Both sensor inputs must be from the same physical I/O connector of the drive. This means that both inputs used in this command must reside on the same I/O connector, either IN/OUT 1 or IN/OUT 2. In the case of BLuDC drives this means that both inputs must reside on the same connector, either the main driver board I/O connector (DB-25) or the top board connector (screw terminal).

### Command Details:

Structure	FD(Parameter #1)(Parameter #2)
Type	BUFFERED
Usage	WRITE ONLY
Non-Volatile	NO
Register Access	None

### Parameter Details:

(See Appendix F: Working With Inputs and Outputs)

### Examples:

Command	Drive sends	Notes
FDX2F4H	-	Launch Feed to Double Sensor move: decel from VE to VC when input 2 changes from high to low (falling), then decel to a stop when input 4 is high
AC50	-	Set accel rate to 50 rev/sec/sec
DE50	-	Set decel rate to 50 rev/sec/sec
DI-1	-	Set move direction to CCW
VE5	-	Set initial velocity to 5 rev/sec
VC1	-	Set change velocity to 1 rev/sec
FD1F2H	-	Launch Feed to Double Sensor move: decel from VE to VC when input 1 changes from high to low (falling), then decel to a stop when input 2 is high

---

## FE - Follow Encoder

---

Compatibility: All drives  
 See also: EG, MT, ST commands

Puts drive in encoder following mode until the given digital or analog input condition is met. The master encoder channels A and B must be wired to the STEP/X1 and DIR/X2 inputs of the drive. Use the EG command before the FE command to set the following resolution, or use the “R” register to dynamically adjust the following resolution while following (Note that in stepper drives the “R” register is equal to 1/2 the EG command). The Step Smoothing Filter is active in FE mode; see the SF command for details.

When the FE command is initiated, the acceleration rate AC is used to ramp the motor up to the following speed. (Doing this prevents extreme accelerations when the master encoder signal is already at its target velocity). The motor continues to follow the master encoder pulses until the input condition is met, at which time the motor decelerates at rate DE to a stop using the DI command as the overall decel distance. If DI is long the motor may not begin decel immediately after the input condition is met. If DI is short the motor may have to decelerate at a rate faster than DE.

Before the input condition is met the motor will follow the master encoder pulses in both CW and CCW directions, regardless of the sign of the DI command. However, once the input condition is met the motor will only stop properly if moving in the direction set by the DI command.

When done executing the drive returns to the mode it was in before executing the FE command.

*NOTE: You must use the appropriate configuration software - Quick Tuner for servos, Configurator for steppers - to set up the STEP/X1 and DIR/X2 inputs for encoder following. Do this by choosing A/B Quadrature in the Position mode settings.*

*NOTE: Take care when changing the “R” register while following because some move parameters will be scaled as well and therefore the move may change unexpectedly.*

### Command Details:

Structure	FE(Parameter #1)
Type	BUFFERED
Usage	WRITE ONLY
Non-Volatile	NO
Register Access	None

### Parameter Details:

(See Appendix F: Working With Inputs and Outputs)

### Examples:

Command	Drive sends	Notes
AC500	-	Limit acceleration in encoder following to 500 rps/s
DI8000	-	Set the stopping offset distance to 8000 counts
FE4L	-	Run in encoder following mode until input 4 is low

## FH - Find Home

Compatibility: SSM, TSM, TXM, SS, SSAC and SV200 series servo drives only  
 See also: DL, AC, DE, VE and VC commands

Find Home will execute specific homing methods as described by the CANopen standard, CiA402. Support for homing methods 1 and 2 are available with this command. These methods require that end-of-travel limit sensors are wired to the limit inputs and configured with the appropriate software or by using the DL (Define Limits) command.

Homing Method 1 will home to the first index detected while moving in the CCW direction after the CW limit switch is reached.

Homing Method 2 will home to the first index detected in the CW direction after the CCW limit switch is reached.

### Homing Method 1

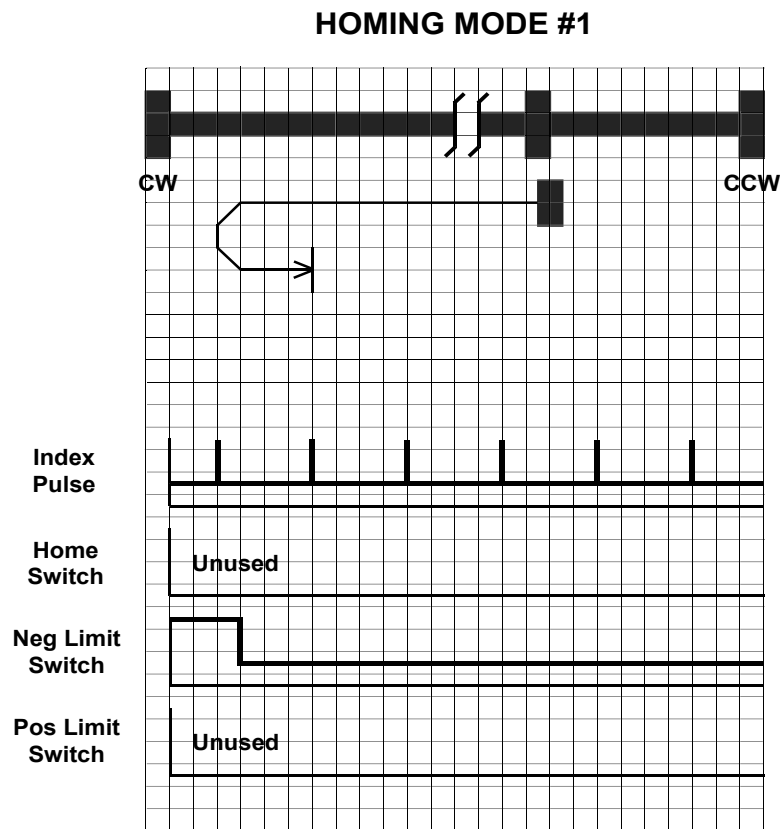

As shown above, the initial direction of movement shall be CW if the CW limit switch is not already triggered. The home position shall be at the first index pulse in the CCW direction after the CW limit switch becomes inactive. First, the motor moves in CW direction and stops when CW limit switch is triggered. Then it moves in CCW direction until the first index is reached after the CW limit switch becomes inactive. Velocity, acceleration and deceleration are set by VE, AC and DE respectively in the first move. Velocity, acceleration and deceleration are set by VC, AC and DE commands respectively in the second move. The index pulse is masked until motion occurs in the CCW direction and the CW limit switch has changed to an inactive state after having been triggered.

The DL command sets the active signal state of the limit switches: end-of-travel limit reached when low (closed) vs. high (open).

**NOTE: DI (Distance) value has no effect on homing direction**

## Homing Method 2

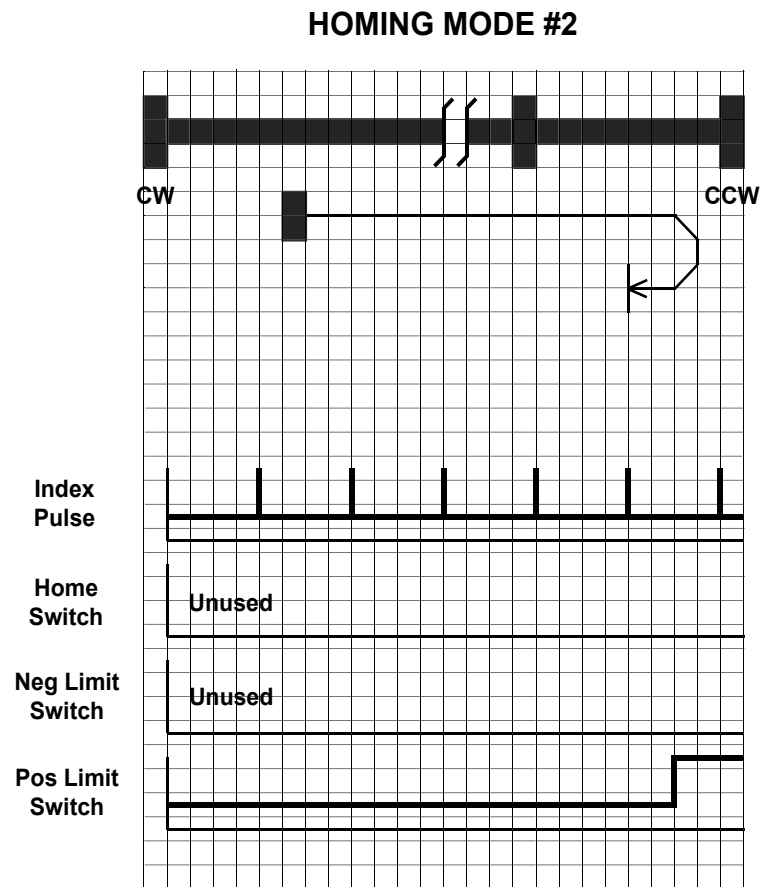

As shown above, the initial direction of movement shall be CCW if the CCW limit switch is not already triggered. The home position shall be at the first index pulse in the CW direction after the CCW limit switch becomes inactive.

First, the motor moves in CCW direction and stops when CCW limit switch is triggered. Then it moves in CW direction until the first index is reached after the CCW limit switch becomes inactive. Velocity, acceleration and deceleration are set by VE, AC and DE respectively in the first move. Velocity, acceleration and deceleration are set by VC, AC and DE commands respectively in the second move. The index pulse is masked until motion occurs in the CW direction and the CCW limit switch has changed to an inactive state after having been triggered.

The DL command sets the active signal state of the limit switches: end-of-travel limit reached when low (closed) vs. high (open).

**NOTE: DI (Distance) value has no effect on homing direction**

### Command Details:

Structure	FH{Parameter #1}
Type	BUFFERED
Usage	WRITE ONLY
Non-Volatile	No
Register Access	None

### Parameter Details:

Parameter #1	Homing Method
- units	Short
- range	1-2

### Examples:

Command	Drive sends	Notes
FH1	%	Homing to the first index pulse reached in the CCW direction after the CW limit switch is reached.

## FI - Filter Input

**Compatibility:** All drives (except STAC5-S)  
**Affects:** All commands using inputs  
**See also:** FX, RC, SD, WI and all feed to sensor commands.  
 See EI for hardware filter alternative, specifically on STAC5 drives.

Applies a digital filter to the given input. The digital input must be at the same level for the time period specified by the FI command before the input state is updated. For example, if the time value is set to 100 the input must remain high for 100 processor cycles before high is updated as the input state. A value of "0" disables the filter.

	All steppers except STAC5	BLu,SV, SVAC3, STAC5	StepSERVO	SV200
<b>processor cycle</b>	100µsec	125µsec	200µsec	250µsec

### BLu, STAC6

This command can be used to apply filters to low speed inputs X3 through X7 on the main driver board of all drives, and can also be used on top board inputs IN3 through IN7 of SE, QE, and Si drives. Reassigning the filters to top board inputs of SE, QE and Si drives is done with the FX command.

### SV, ST-Q/Si

This command can be used to apply filters to low speed inputs X3 through X8.

### ST-S, STM17, STM23 , SSM

This command can be used to apply filters to inputs STEP, DIR, and EN

### STM24-SF/QF

For drives with Flex I/O, this command can be used to apply filters to any input.

### STM24-C

This command can be used to apply filters to inputs IN1, IN2 and IN3.

### STAC5-Q/IP, SVAC3-Q/IP

This command can be used to apply filters to inputs IN5 - IN8.

### TSM-P

This command can be used to apply filters to inputs X1 - X4.

### TSM-S/Q/C

This command can be used to apply filters to inputs X3 - X6.

### TXM-S/Q/IP

This command can be used to apply filters to inputs X1 - X3.

### TXM-C

This command can be used to apply filters to inputs X3 - X5.

### SS

This command can be used to apply filters to inputs X5 - X8.

### SV200

This command can be used to apply filters to inputs X9 - X12.

## Command Details:

Structure	FI{Parameter#1}{Parameter#2}
Type	BUFFERED
Usage	READ/WRITE
Non-Volatile	YES, except BLu servos
Register Access	None

## Parameter Details:

(See Appendix F: Working With Inputs and Outputs)

## Examples:

Command	Drive sends	Notes
FI4100	-	Requires that input X4 (if FX=1) maintain the same state (low or high) for 100 total processor cycles before the drive registers the change
FI4	FI4=100	



## Digital Input Filters in Detail

Drives have the capability to apply digital filters to selected digital inputs. With factory defaults, digital inputs are not filtered through any means other than the natural response time of the optical couplers used in the input circuits. Analog filtering has purposely not been implemented so as to not restrict the input circuit. However, digital filtering is available on select digital inputs to enhance the usage of those inputs.

On occasion, electrical noise at digital inputs may create a false trigger or even a double-trigger. This can often happen when using mechanical switches that “bounce” when activated or deactivated. For this reason there may be a need to filter an input to eliminate the effects of these noise conditions. Digital filtering gives the greatest flexibility by allowing the user to select the amount of filtering required to eliminate the effects of noise or bounce.

The digital filters work by continuously monitoring the level of the inputs to which filters have been applied using the FI command. During each processor cycle (servo and STAC5 = 125  $\mu$ sec, other steppers = 100  $\mu$ sec), internal counters associated with the filters are incremented or decremented depending on whether each input is high (open) or low (closed), respectively. When a command that accesses a digital input is executed, the state of the input requested by that command will be updated only after the internal counter for that input’s filter reaches a threshold value. This threshold value is also known as the filter value, and is set by the FI command. The flow chart to the right shows how a digital filter works.

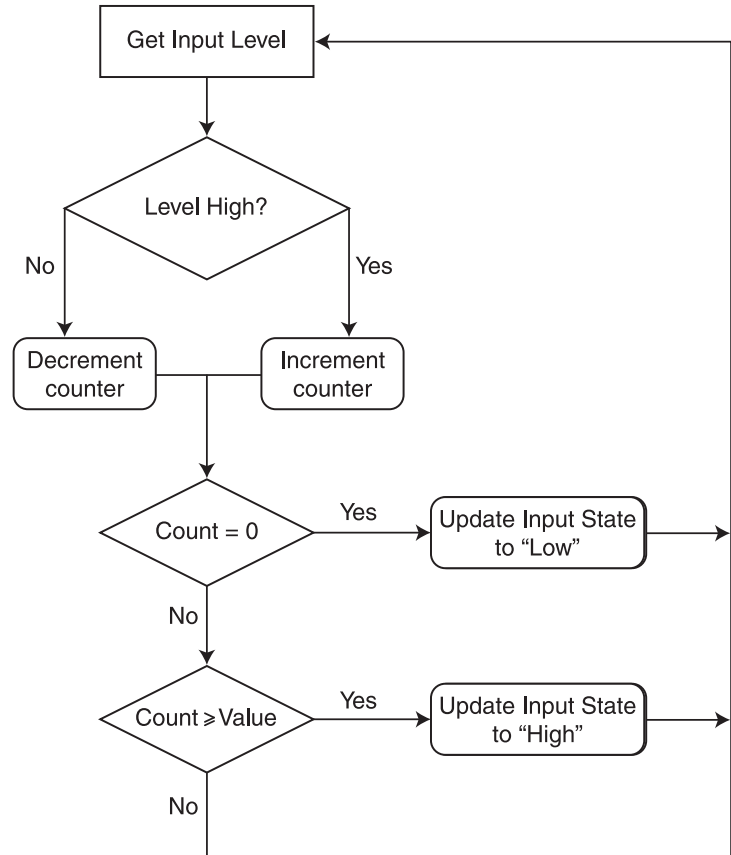

For example, if we apply a digital filter of 2 milliseconds to input 3 on a STAC6 stepper drive, it means we’d like the level of input 3 (low or high) to be true for a total of 2 milliseconds before the processor updates the state of input 3 to the state requested by the command currently being executed. If the command being executed is a WI3L command, which literally means “wait for input 3 low”, it means the processor will wait until the level of input 3 has been low for a total of 2 milliseconds before updating the state of the input as low and finishing the WI3L command. If by chance input 3 has already been low for the prerequisite 2 milliseconds when the WI3L command is initiated, there will be no delay in executing the command. On the other hand, if input 3 is high when the WI3L command is initiated, there will be an additional minimum delay of 2 milliseconds after the input changes state from high to low. It is important to understand that any fluctuation of the physical signal, by switch bounce or electrical noise, will contribute to a lag in the processed signal.

To turn filtering of input 3 on we need to use the FI command. The FI command works in processor cycles and we’re using a STAC6 stepper drive in this example, so a value of 1 equals 100 microseconds. To filter the EN input for 2 milliseconds the value of the FI command would then be 2 msec divided by 100 usec, or 20. The correct syntax for the FI command would then be “FI320”.

As can be seen from the example and flow chart above, the functioning of a digital input filter incorporates an averaging effect on the level of the input. This means that in the example above, if the level of the input 3 were fluctuating between low and high over a range of processor cycles (maybe due to electrical noise), the drive would not update the input state until the internal counter value went to zero (for a low state) or the filter value (for a high state). Another example of this averaging effect is if the input were connected to a pulse train from a signal generator with a duty cycle of 51% high and 49% low. The input state would eventually be set to a high state, depending on the time value used in the pulse train.

### *Host Command Reference*

Filter values are non-volatile for all but the BLu series of servo drives, if followed by an SA command. With a BLu servo drive, the filter values are lost at power-down and must be set each time the drive is powered on.

*NOTE: A side effect of the digital filter, which is true of any filter, is to cause a lag in the response to an input level. When an input changes state and is solid (no noise), the lag time will be the same as the filter value. When noise is present the lag may be longer.*

## FL - Feed to Length

Compatibility: All drives  
 See also: AC, DE, DI, VE commands

Executes a relative move command. Move distance and direction come from the last DI command. Speed, accel and decel are from the VE, AC and DE commands, respectively. Executing the FL command with no parameter initiates a feed to length move that uses the last DI command for direction and distance. Executing the FL command with a parameter uses the parameter settings for direction and distance without changing the DI command.

### Command Details:

Structure	FL{Parameter #1}
Type	BUFFERED
Usage	WRITE ONLY
Non-Volatile	NO
Register Access	None

### Parameter Details:

Parameter #1	Relative distance
- units	counts or steps
- range	-2,147,483,647 to 2,147,483,647 sign determines direction: "-" for CCW, no sign for CW

### Examples:

Command	Drive sends	Notes
DI20000	-	Set distance to 20000 counts in the CW direction
FL	-	Launch Feed to Length move
FL20000	-	Launch Feed to Length move of 20000 counts in the CW direction without affecting the DI command
FL-400	-	Launch Feed to Length move of 400 counts in the CCW direction without affecting the DI command

---

## FM - Feed to Sensor with Mask Distance

---

Compatibility: All drives  
 See also: FS command

Executes a Feed to Sensor command (see FS command) except sensor is ignored for the first DC counts of the move. In other words the sensor is “masked” for a beginning portion of the move. This command is useful for ignoring noise from a mechanical switch or for clearing a part before sensing the next one.

### Command Details:

Structure	FM(Parameter #1)
Type	BUFFERED
Usage	WRITE ONLY
Non-Volatile	NO
Register Access	None

### Parameter Details:

(See Appendix F: Working With Inputs and Outputs)

### Examples:

Example: Parts are feeding on a conveyor which is being driven by the motor. A sensor detects the leading edge of the part and stops. If the part has a hole in it, which is common, when you attempt to feed the next part into position you may in fact stop after feeding the previous part only a short distance because the sensor will register the hole in the part rather than the leading edge of the next part. The solution is to use the FM command instead of the FS command, and to set the DC command for the size of the part (or greater).

Example continued: The parts on a conveyor are 6 inches long. Your mechanical linkage provides 2000 steps per inch. You want the leading edge of the part to stop moving 1 inch past the sensor, and therefore 5 inches of the part will not have gone past the sensor yet. To avoid holes in the part and see the next part properly, we need to mask 5 inches or more of the move. Here are the commands you could use.

Command	Drive sends	Notes
DI2000	-	Set distance to stop past sensor at 1 inch (2000 steps)
DC10200	-	Set distance over which to ignore (mask) the sensor at 5.1 inches, enough to allow the previous part to completely clear the sensor
FM1F	-	Initiate FM move. Sensor is connected to input 1 and will close when it sees a part

## FO - Feed to Length and Set Output

Compatibility: All drives  
 See Also: DC, DI, AO, BO, MO commands

Same as Feed to Length (FL) but changes the state of an output during the move. Overall move distance is defined by the DI command. Accel rate, decel rate, and velocity are set by the AC, DE and VE commands, respectively. Distance within overall move at which output condition should be set is defined by the DC command. If DC is equal to or greater than DI, the input condition will not be met during the move and the output will not be set.

*NOTE: Dedicated output functions - alarm output, brake output, motion output - must be configured as general purpose before the FO command can be used with the drive's output. See AO, BO, and MO commands.*

### Command Details:

Structured	FO(Parameter #1)
Type	BUFFERED
Usage	WRITE ONLY
Non-Volatile	NO
Register Access	None

### Parameter Details:

(See Appendix F: Working With Inputs and Outputs)

### Examples:

Example: You're feeding parts to be cut to length. For maximum throughput, you want to trigger the cut-off knife as the part is nearing the final position.

Command	Drive sends	Notes
AC100	-	Set accel rate to 100 rev/sec/sec
DE100	-	Set decel rate to 100 rev/sec/sec
VE2.5	-	Set velocity to 2.5 rev/sec
DI20000	-	Overall move distance set to 20000 steps
DC15000	-	Set output distance set to 15000 steps
FO1L	-	Initiate move and set output low at 15000 steps

---

## FP - Feed to Position

---

Compatibility: All drives

See also: AC, DE, DI, SP, VE commands

Executes an absolute move command. Move position comes from the last DI command. Speed, accel and decel are from VE, AC and DE commands, respectively. Executing the FP command with no parameter initiates a feed to position move that uses the last DI command for position. Executing the FP command with a parameter uses the parameter for position without changing the DI command.

### Command Details:

Structure	FP{Parameter #1}
Type	BUFFERED
Usage	WRITE ONLY
Non-Volatile	NO
Register Access	None

### Parameter Details:

Parameter #1	Absolute position
- units	counts or steps
- range	-2,147,483,647 to 2,147,483,647

### Examples:

Example: After homing the motor you want to zero the home position and move to an absolute position 8000 counts (or steps) from the new home position.

Command	Drive sends	Notes
SP0	-	Set current motor position as absolute zero
DI8000	-	Set move position to 8000 counts/steps
FP	-	Launch Feed to Position
FP8000	-	Launch Feed to Position to 8000 counts/steps without affecting the "D" register
FP8000	-	Motor is already at position 8000, no motion occurs.

## FS - Feed to Sensor

Compatibility: All drives

See also: FD, FM and FY commands; see AT command for using AIN as sensor input

Executes a Feed to Sensor command. Requires input number and condition. The motor moves until a sensor triggers the specified input condition, then stops a precise distance beyond the sensor. The stop distance is defined by the DI command. The direction of rotation is defined by the sign of the DI command ("- for CCW, no sign for CW). Speed, accel and decel are from the last VE, AC and DE commands, respectively.

A motor moving at a given speed, with a given decel rate, needs a certain distance to stop. If you specify too short a distance for DI the drive may overshoot the target. Use the following formula to compute the minimum decel distance, given a velocity V (in rev/sec) and decel rate D (in rev/sec/sec.). R = steps/rev, which will equal the encoder resolution for a servo motor and the EG setting for a step motor.

$$\text{minimum decel distance} = \frac{(V)^2(R)}{2(D)}$$

Note that it is possible to use an analog input (AIN) as a discrete sensor by configuring a threshold point. See the AT command for details.

### Command Details:

Structure	FS(Parameter #1)
Type	BUFFERED
Usage	WRITE ONLY
Non-Volatile	NO
Register Access	None

### Parameter Details:

(See Appendix F: Working With Inputs and Outputs)

### Examples:

Command	Drive sends	Notes
FS1L	-	Launch move and decel to stop when sensor tied to input 1 is low
FS3R	-	Launch move and decel to stop when sensor tied to input 3 changes from low to high (rising edge)
FSX5L	-	Launch move and decel to stop when sensor tied to input X5 is low

## FX - Filter select inputs

Compatibility: All drives (except STAC5, SVAC3)  
 Affects: FI command on SE, QE, and Si drives  
 See also: FI command

The FX command allows changing the target inputs of a drive's digital input filters from the main board X3 through X7 inputs to the top board IN3 through IN7 inputs. This can only be done on SE, QE, and Si drives with firmware 1.53U or later.

### Command Details:

Structure	FX{Parameter #1}
Type	BUFFERED
Usage	READ/WRITE
Non-Volatile	NO
Register Access	None

### Parameter Details:

Parameter #1	Digital inputs selector
- units	integer
- range	0 = top board inputs of SE, QE, and Si drives 1 = main board inputs of all drives

### Examples:

Command	Drive sends	Notes
FX0	-	Cause digital input filters set by FI command to affect top board inputs IN3 through IN7 of SE, QE, and Si drives.
FX	FX=1 X3 through X7.	Digital filters are set to be applied to main driver board inputs



## FY - Feed to Sensor with Safety Distance

Compatibility: All drives

See also: DC, FD, FM and FS commands; see AT command for using AIN as sensor input

Executes a Feed to Sensor move while monitoring a predefined safety distance DC. DI defines the direction of rotation and the stop distance to move after the sensor triggers the stop input condition. Accel rate, decel rate, and velocity are set by the AC, DE, and VE commands, respectively. Note that the maximum final motor position will be the safety distance plus the distance required to decelerate the load, which is dependent on the decel rate DE.

*NOTE: If the safety distance is exceeded, three things will happen. The motor is stopped, the drive sends the host an exclamation point ("!") and adds a value of 1 to the Other Flags register ("F" register). This can occur if the sensor is not encountered before DC is reached, or if the DI value is set high enough that the total move distance would exceed the maximum of DC plus the deceleration distance determined by DE.*

This command is useful for avoiding machine jams or detecting the end of a roll of labels. For example, you are feeding labels and you want to stop each label 2000 steps after the sensor detects the leading edge. The labels are 60,000 steps apart. Therefore, if you move the roll more than 60,000 steps without detecting a new label, you must be at the end of the roll.

*NOTE: DI must be assigned a value greater than zero when used with the FY command. If DI is set to zero (DI0), the motor will not move.*

### Command Details:

Structure	FY(Parameter #1)
Type	BUFFERED
Usage	WRITE ONLY
Non-Volatile	NO
Register Access	"F" (022) Executing the FY command will put a value of 2 in the "F" register when the sensor is successfully found, or a value of 1 in the "F" register if the safety distance is met. If you plan to use the "F" register for monitoring the success of the FY command you must zero the register before each FY command by executing RLF0.

### Parameter Details:

(See Appendix F: Working With Inputs and Outputs)

#### Examples:

Command	Drive sends	Notes
DI2000	-	Set distance to stop beyond sensor to 2000 counts/steps
DC60000	-	Set safety distance to 60000 counts/steps
FY2L	-	Launch Feed to Sensor: motor will stop when input 2 is low or when 60000 counts/steps are reached: whichever event comes first

When using the SE, QE, or Si drives and needing to access the main driver board inputs...

FYX2L	-	Launch Feed to Sensor: motor will stop when main driver board input 2 is low or when 60000 counts/steps are reached: whichever event comes first
-------	---	--

---

## GC - Current Command

---

Compatibility: Servo drives only  
 Affects: Commanded motor current  
 See also: CM command

Sets or requests the immediate current command for the servo motor and drive when the servo drive is set for Command Mode 1 (CM1).

*NOTE: Setting this value may make the servo motor run to a very high speed, especially if there is no load on the motor. Take care when using this command.*

### Command Details:

Structure	GC{Parameter #1}
Type	IMMEDIATE
Usage	READ/WRITE
Non-Volatile	Yes
Register Access	"G" (023)

### Command Details:

Parameter #1	RMS Current
- units	0.01 amps rms
- range	-2000 to +2000 (+/- 20 amps rms)

### Examples:

Command	Drive sends	Notes
CM1	-	Set servo drive to Commanded Current Command Mode
GC100	-	Set current to motor at 1 A rms
GC-100	-	Set current to motor at -1 A rms (opposite direction)

## GG - Controller Global Gain Selection

Compatibility: SV200 series servo drives only  
 Affects: Controller PID parameters, Input #7  
 See also: KP, KG commands

Defines the usage of input X7 for PID controller global gain selections.  
 GG1: select KP when input X7 is open, and select KG when input X7 is closed.  
 GG2: select KP when input X7 is closed, and select KG when input X7 is open.  
 GG3: Input X7 is used as general purpose input. Select KP as global gain.

### Command Details:

Structure	GG{Parameter #1}
Type	BUFFERED
Usage	READ/WRITE
Non-Volatile	Yes
Register Access	No

### Command Details:

Parameter #1	See above
- units	integer number
- range	1~3

### Examples:

Command	Drive sends	Notes
GG1	%	Set the usage of global gain selection to 1
GG	GG =1	The usage of global gain selection is 1

## HA - Homing Acceleration

Compatibility: SSM, TSM, TXM, SS, SSAC and SV200 series servo drives only  
 See also: DL, HL, HV, HO, EH, HS commands

Sets or requests the acceleration rate used in Extended Homing Mode and Hard Stop Homing Mode in rev/sec/sec.

*NOTE: This command is designed for to set the acceleration rate for each step of the Extended Homing or Hard Stop Homing process. Please see the detail reference to EH and HS command pages for details.*

### Command Details:

Structure	HA{Parameter #1}{Parameter #2}
Type	BUFFERED
Usage	READ/WRITE
Non-Volatile	Yes
Register Access	None

### Parameter Details:

Parameter #1	Select Step
- units	Integer
- range	1~3
Parameter #2	Acceleration rate
- units	rev/sec/sec (rps/s)
- range	0.167 to 5461.167 (resolution is 0.167 rps/s)
Default value	HA1: 100 rps/s HA2: 100 rps/s HA3: 10rps/s

### Examples:

Command	Drive sends	Notes
HA120	%	Sets the homing acceleration to 20 rps/s for step 1 of homing process
HA1	HA1=20	Homing accel for step 1 is set to 20 rps/s

## HC – Hard Stop Current

Compatibility: StepSERVO models & SV200 servo drives only  
 Affects: Hard Stop Homing  
 See also: HA, HL, HS, HO, HV

Sets or requests the threshold current to be used in Hard Stop Homing mode (see HS command). This current value cannot be greater than the continuous current setting (CC). The current setting is used to determine when the motor has hit the hard stop position. To ensure the protection of mechanical components within the system, it is important to set this value sufficiently low.

### Command Details:

Structure	HC{Parameter #1}
Type	BUFFERED
Usage	READ/WRITE
Non-Volatile	YES
Register Access	None

### Parameter Details:

Parameter #1	Current in Hard Stop Homing mode
- units	amps (resolution is 0.01 amps)
- range	0.01 – CC (where CC is the continuous current setting)

### Examples:

Command	Drive sends	Notes
HC1	%	Sets Hard Stop Current to 1 Amp.
HC	HC=1	

## HD - Hard Stop Fault Delay

Compatibility: Stepper drives with Encoder Feedback  
 See also: EF and PF commands

Specifies the amount of time the drive will attempt to recover from a stall while in Stall Prevention mode.

In Stall Prevention mode (See EF command), the drive will attempt to recover from a stall condition. This delay setting dictates the amount of time the drive will work to recover from such a stall before faulting. This allows the machine to recover from minor disruptions without unnecessarily working to recover from an unrecoverable state.

### Command Details:

Structure	HD{Parameter #1}
Type	BUFFERED
Usage	WRITE ONLY
Non-Volatile	YES
Register Access	None

### Parameter Details:

Parameter #1	Hard Stop Fault Delay Time
- units	integer
- range	1 - 32000 milliseconds

### Examples:

Command	Drive sends	Notes
HD1000	-	In the event of a stall, instruct the drive to attempt to recover for 1000ms (1 second) before faulting.

## HG - 4th Harmonic Filter Gain

Compatibility: Stepper drives only  
 Affects: Low-speed performance of step motors  
 See also: HP command

Sets or requests the 4th harmonic filter gain setting. This setting works in conjunction with the 4th harmonic filter phase setting (HP) to reduce low-speed torque ripple in step motors.

*NOTE: We strongly suggest you set this value in the ST Configurator software application only.*

### Command Details:

Structure	HG{Parameter #1}
Type	IMMEDIATE
Usage	READ/WRITE
Non-Volatile	YES only when set in Configurator software, otherwise NO
Register Access	None

### Parameter Details:

Parameter #1	Filter gain
- units	integer number
- range	0 - 32767

### Examples:

Command	Drive sends	Notes
HG8000	-	Set filter gain value to 8000
HG	HG=8000	

## HL - Homing Deceleration

Compatibility: SSM, TSM, TXM, SS, SSAC and SV200 series servo drives only  
 See also: DL, HA, HV, HO, EH, HS commands

Sets or requests the deceleration rate used in Extended Homing mode and Hard Stop Homing mode.

*NOTE: This command is designed to set the deceleration rate for each step of the Extended Homing or Hard Stop Homing process. Please reference EH and HS command pages for details.*

### Command Details:

Structure	HL{Parameter #1}{Parameter #2}
Type	BUFFERED
Usage	READ/WRITE
Non-Volatile	Yes
Register Access	None

### Parameter Details:

Parameter #1	Select Step
- units	Integer
- range	1~3
Parameter #2	Deceleration rate
- units	rev/sec/sec (rps/s)
- range	0.167 to 5461.167 (resolution is 0.167 rps/s)
Default value	HL1: 100 rps/s HL2: 100 rps/s HL3: 10rps/s

### Examples:

Command	Drive sends	Notes
HL220	%	Sets the homing deceleration to 20 rps/s for step 2 of homing process
HL2	HL2=20	Homing accel for step 2 is set to 20 rps/s



## HO – Home Offset

Compatibility: StepSERVO & SV200 series servo drives only  
 Affects: Homing modes EH & HS  
 See also: DL, EH, HA, HL, HS, HV commands

Sets or requests the move distance in steps after the home sensor has been reached in Extended Homing (EH) and Hard Stop Homing (HS) modes. The sign of HO indicates the initial move direction when homing begins: no sign (positive) means CW and a “-” (negative) sign means CCW.

### Command Details:

Structure	HO{Parameter #1}
Type	BUFFERED
Usage	READ/WRITE
Non-Volatile	YES
Register Access	None

### Parameter Details:

Parameter #1	Distance after Home sensor reached
- units	steps
- range	-2,147,483,647 to 2,147,483,647 sign determines direction: “-” for CCW, no sign for CW
Default value	2000

### Examples:

Command	Drive sends	Notes
HO20000	%	Sets Home Offset distance to 20000 steps; initiates homing in CW direction.
HO	HO=20000	

## HP - 4th Harmonic Filter Phase

Compatibility: Stepper drives only  
 Affects: Low-speed performance of step motors  
 See also: HG command

Sets or requests the 4th harmonic filter phase setting. This setting works in conjunction with the 4th harmonic filter gain setting (HG) to reduce low-speed torque ripple in step motors.

*NOTE: We strongly suggest you set this value in the ST Configurator software application only.*

### Command Details:

Structure	HP{Parameter #1}
Type	IMMEDIATE
Usage	READ/WRITE
Non-Volatile	YES only when set in Configurator software, otherwise NO
Register Access	None

### Parameter Details:

Parameter #1	Filter phase
- units	integer number
- range	-125 to +125

### Examples:

Command	Drive sends	Notes
HG105	-	Set 4th harmonic filter gain to 105
HG	HG=105	

## HS - Hard Stop Homing

Compatibility: SSM, TSM, TXM, SS, SSAC drives  
 See also: HA, HC, HO, HL, HV commands

Executes the Hard Stop Homing process, which may optionally search for the first encoder index pulse after finding a rigid mechanical end stop in the chosen direction. The current threshold must first be set with the HC command, as well as the homing velocity (HV), accel (HA), and decel (HL) for each step of the homing process. The start direction comes from the sign of the HO command ("- is CCW, no sign is CW). The Home Offset (HO) value is used for the final offset move once the hard stop or index has been reached.

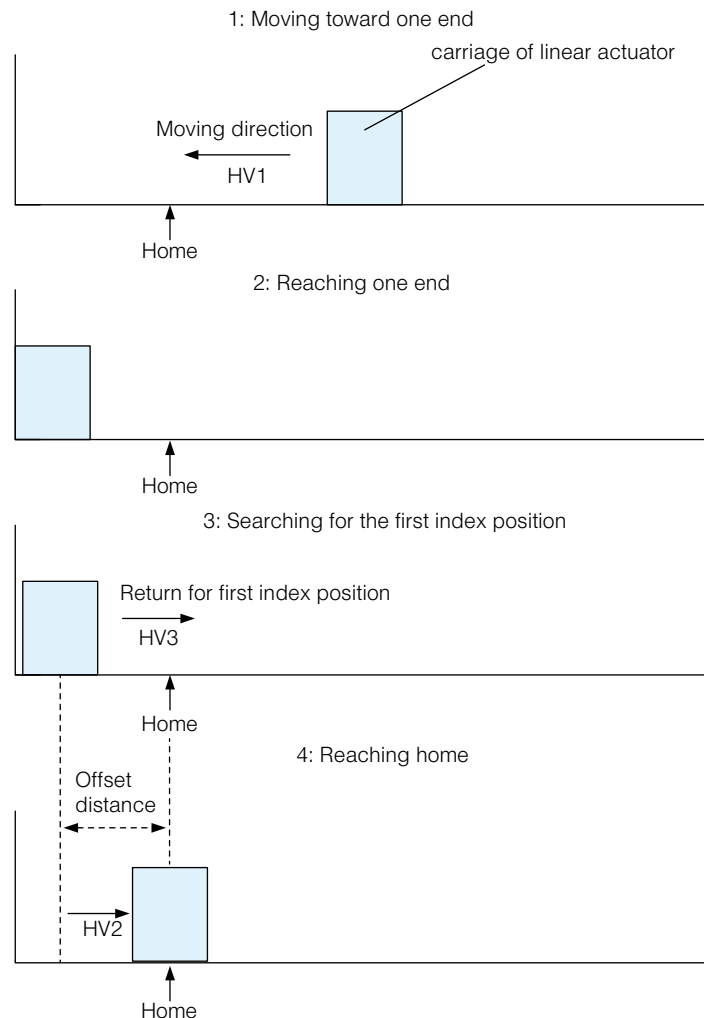

HV1: Velocity when searching for mechanical end stop.  
 HV2: Velocity when moving offset distance set by HO.  
 HV3: Velocity when searching for encoder index if desired.

### Command Details:

Structure	HS{Parameter #1}
Type	BUFFERED
Usage	WRITE
Non-Volatile	None
Register Access	None

### Parameter Details:

Parameter #1	Hard Stop Home with or without index
- units	none
- range	0 = without index 1 = with index

### Examples:

Command	Drive sends	Notes
HS1	-	Execute the hard stop homing process AND use encoder index

## HV - Homing Velocity

Compatibility: SSM, TSM, TXM, SS, SSAC and SV200 series servo drives  
 Affects: DL, HA, HL, HO, HS, EH commands

Sets or requests the shaft speed used in the Extended Homing (EF) and Hard Stop Homing (HS) modes.

HV1: Homing velocity for searching Limit Sensor and Home sensor for Extended Homing (EH). For Hard Stop Homing (HS), this is the velocity used while seeking the hard stop.

HV2: Homing velocity for moving the offset distance.

HV3: Homing velocity for returning back to home sensor after offset distance has been reached for Extended Homing (EH). For Hard Stop Homing (HS), this is the velocity used for seeking the index pulse after the hard stop is reached and before the offset move..

### Command Details:

Structure	HV{Parameter #1}{Parameter #2}
Type	BUFFERED
Usage	READ/WRITE
Non-Volatile	YES
Register Access	None

### Parameter Details:

Parameter #1	Select Step
- units	integer
- range	1~3
Parameter #2	Move velocity
- units	rev/sec (rps)
- range	0.0042 - 80.0000 (resolution is 0.0042)
Default value	HV1: 10rps HV2: 5rps HV3: 0.5rps

### Examples:

Command	Drive sends	Notes
HV110	%	Setting the homing velocity to 10 rps for step 1
HV1	HV1=10	Reading Homing velocity for step 1

---

## HW - Hand Wheel

---

Compatibility: All drives

See also: EG, FE, and MT commands; see AT command for using analog input as sensor input

Puts drive in “hand wheel” mode until the given digital or analog input condition is met. Hand wheel mode is a kind of low speed following mode, where the motor follows master encoder signals as a hand wheel is manually turned. This command differs from the FE command in that the AC, DE, and DI commands are not used in any way. In other words, the motor will attempt to follow the master encoder signals without injecting any ramps to smoothly approach high frequency target speeds or to come to a stop when the stop input condition is met.

### BLu, SV, STAC6, ST-Q/Si, STAC5, SVAC3

Inputs X1 and X2 are used for connecting the A and B signals of the encoder-based handwheel. The EG (Electronic Gearing) command defines the following resolution of the motor.

### ST-S, STM17/23

Inputs STEP and DIR are used for connecting the A and B signals of the encoder-based handwheel. The EG (Electronic Gearing) command defines the following resolution of the step motor.

### Command Details:

Structure	HW(Parameter #1)
Type	BUFFERED
Usage	WRITE ONLY
Non-Volatile	NO
Register Access	None

### Parameter Details:

(See Appendix F: Working With Inputs and Outputs)

### Examples:

Command	Drive sends	Notes
HWX4L	-	Run in hand wheel mode until input X4 low

---

## Immediate Status Commands

---

The following section describes commands that return “Immediate” results when sent. These selected commands provide useful information for monitoring internal values from the drive.

Data can be sent out in two different formats, Hexadecimal or Decimal. By default the data is returned in Hexadecimal because of its speed and efficiency. Conversion to ascii in the Decimal format is slower and causes a slight delay that varies in length. Hexadecimal minimizes the overhead required to convert the internal binary data to ascii form. This speeds up the process of sending out the requested data thus giving the most recent value. Typically, applications written on more powerful Host computers can easily convert a hexadecimal value to an integer value.

The Immediate Format (IF) command sets the format of the returned data to hexadecimal or decimal. For cases where a slight delay is acceptable the data can be sent out in decimal form. Setting the format affects all of the “I” commands (except IH and IL). See IF command in the following pages.

All the “I” commands can be used at any time and at the fastest rate possible limited only by the given Baud Rate (See BR and PB commands). As with any immediate type command it is acted upon as soon as it’s received. Regardless of format (hex or dec) there will be a slight delay in processing the command. “Real time” usage of the data must be carefully analyzed.

## IA - Immediate Analog

Compatibility: All drives  
 See Also: AD, AV, AZ and IF commands

### BLu, SV, STAC6, ST-Q/Si

Requests present analog input value from the given source. There are three different analog values that can be accessed. With no parameter the IA command returns the Analog Command value which is derived from the analog inputs with gain and offset values applied as set in *Quick Tuner* or *Configurator* or via the AD, AV and/or AZ commands. When a parameter is given raw (unscaled) analog input values are returned.

### ST-S, STM

Requests present analog input value. There are two different analog values that can be accessed. With no parameter the IA command returns the Analog Command value which is derived from the analog input with gain and offset values applied as set in *ST Configurator* or via the AD, AV and/or AZ commands. When a parameter is given raw (unscaled) analog input values are returned.

*Note: The output of the IA command is formatted by IF. See IF for further details.*

### Command Details:

Structure	IA{Parameter #1}
Type	IMMEDIATE
Usage	READ ONLY
Non-Volatile	NO
Register Access	All drives... "a" (049) Analog Command  BLu, SV, STAC6, ST-Q/Si... "j" (058) Analog input 1 (unscaled) "k" (059) Analog input 2 (unscaled)  ST-S, STM... "j" (058) AIN (unscaled)

### Parameter Details:

#### BLu, SV, STAC6, ST-Q/Si, STAC5, SVAC3

Parameter #1	Analog input
- units	integer
- range	No parameter or 0 = Analog command 1 = Analog input 1 (unscaled) 2 = Analog input 2 (unscaled) 3 = Expanded analog input (SE, QE, and Si models)

#### ST-S, STM17-S/Q/C, STM23-Q

Parameter #1	Analog input
- units	integer
- range	No parameter or 0 = Analog command 1 = AIN (unscaled)



**Examples:**

Command	Drive sends	Notes
IFD IA	- IA=2.5	Return future Immediate command responses in Decimal format Analog Command is at mid range when drive is set to 0-5 volt input. (In Decimal mode neither leading nor trailing zeros are used, so the response length is not strictly defined and may be up to four digits in length.)
IFH IA	- IA=1FEE	Return future Immediate command responses in Hexadecimal format. Analog Command represented as hexadecimal value. (Leading zeros are used for small values, so the response will always be four digits in length.)

## IC - Immediate Current (Commanded)

Compatibility: All drives

### Servo drives

Requests the present RMS current commanded by the servo loop. This may not be the actual current at the motor windings. Most AC servo motors are commutated using a sinusoidal current waveform that is a “peak” value and not directly represented by the commanded current. The commanded current is the average RMS current being asked of the driver. Typically with a well tuned current loop the RMS current in the servo motor is well represented by this value.

### Stepper drives

Requests the present (peak-of-sine) current applied to each motor phase. This value will change depending on what the motor is doing at the moment the command is processed. If the motor is moving this value will equal the CA (STM only) or CC value. If the motor is not moving this value will equal the CI value.

### Command Details:

Structure	IC
Type	IMMEDIATE
Usage	READ ONLY
Non-Volatile	NO
Register Access	“c” (051)
Units	0.01 amps

### Examples:

Command	Drive sends	Notes
IC	IC=015E	3.5 amps
IC	IC=FEA2	-3.5 amps

If the IF command is set with Parameter #1=D

IFD	-	Set values to be read back in decimal
IC	IC=350	3.5 amps
IC	IC=-350	-3.5 amps

## ID - Immediate Distance

Compatibility: All drives

### BLu, STAC6

Requests the total relative distance moved in the last completed move.

### SV, ST-Q/Si, ST-S, STM

Requests the immediate relative distance traveled from the beginning of the last move. Once the move is finished the value will be equal to the relative distance of that last move until another move is initiated, at which time the value will zero and begin tracking the new relative distance moved.

### Command Details:

Structure	ID
Type	IMMEDIATE
Usage	READ ONLY
Non-Volatile	NO
Register Access	"d" (052)
Units	encoder counts (servo) steps (stepper)

### Examples:

Command	Drive sends	Notes
ID	ID=00002710	10000 (10000 counts into CW move)
ID	ID=FFFFD8F0	-10000 (10000 counts into CCW move)

If the IF command is set with Parameter #1=D

ID	ID=10000	10000 counts into CW move
ID	ID=-10000	10000 counts into CCW move

---

## IE - Immediate Encoder

---

Compatibility: Servo drives and stepper drives with encoder feedback

Requests present encoder position.

### Command Details:

Structure	IE
Type	IMMEDIATE
Usage	READ ONLY
Non-Volatile	NO
Register Access	"e" (053)
Units	encoder counts

### Examples:

Command	Drive sends	Notes
IE	IE=00002710	Encoder position is (+)10000 counts
IE	IE=FFFFD8F0	Encoder position is -10000 counts

If the IF command is set with Parameter #1=D

IE	IE=10000	Encoder position is (+)10000 counts
IE	IE=-10000	Encoder position is -10000 counts

## IF - Immediate Format

Compatibility: All drives

Affects: Immediate Commands IA, IC, ID, IE, IP, IT, IU, IV and IX

Sets the data format, hexadecimal or decimal, for data returned using all “I” commands (except IH, IL, IO and IS).

Data can be requested from the drive in two formats: hexadecimal or decimal. By default data is returned in hexadecimal because of its speed and efficiency. Conversion to ascii in the decimal format is slower and causes a slight delay that varies in length. Hexadecimal minimizes the overhead required to convert the internal binary data to ascii form. This speeds up the process of sending out the requested data thus giving the most recent value. Typically, applications written on more powerful host computers can easily convert a hexadecimal value into a decimal value.

All “I” commands can be used at any time and at the fastest rate possible limited only by the given baud rate (see BR and PB commands). Immediate commands are executed as they are received, regardless of what is in the drive’s command buffer. Regardless of format (hex or dec) there will be a slight delay in processing the response to an “I” command. “Real time” usage of the data must be carefully analyzed.

### Command Details:

Structure	IF{Parameter #1}
Type	IMMEDIATE
Usage	READ/WRITE
Non-Volatile	YES
Register Access	None

### Parameter Details:

Parameter #1	Return format
- units	letter
- range	H (hexadecimal) or D (decimal)

### Examples:

Command	Drive sends	Notes
IFH	-	Sets format to Hexadecimal
ID	ID=00002710	Distance is 10000 counts
IF	IF=H	
IFD	-	Sets format to Decimal
ID	ID=10000	Distance is 10000 counts
IF	IF=D	

## IH - Immediate High Output

Compatibility: All drives  
 See also: IL, SO commands

Sets an output high (open) immediately. Use SO instead if you don't want the output to change until a buffered command (like a move) is complete.

### Command Details:

Structure	IH(Parameter #1)
Type	IMMEDIATE
Usage	WRITE ONLY
Non-Volatile	NO
Register Access	None

### Parameter Details:

(See Appendix F: Working With Inputs and Outputs)

### Examples:

Command	Drive sends	Notes
IH1	-	Output 1 goes high immediately
IH2	-	Output 2 goes high immediately

To force Outputs on main driver board when using an SE, QE or Si drive

IHY1	-	Output 1 of main driver board goes high immediately
IHY2	-	Output 2 of main driver board goes high immediately

## IL - Immediate Low Output

Compatibility: All drives

See also: IH, SO commands.

Sets an output low (closed) immediately. Use SO instead if you don't want the output to change until a buffered command (like a move) is complete.

### Command Details:

Structure	IL(Parameter #1)
Type	IMMEDIATE
Usage	WRITE ONLY
Non-Volatile	NO
Register Access	None

### Parameter Details:

(See Appendix F: Working With Inputs and Outputs)

### Examples:

Command	Drive sends	Notes
IL1	-	Output 1 goes low immediately
IL2	-	Output 2 goes low immediately

To force Outputs on main driver board when using an SE, QE, or Si drive

ILY1	-	Output 1 of main driver board goes low immediately
ILY2	-	Output 2 of main driver board goes low immediately

## IO - Output Status

Compatibility: All drives

With no parameter this command requests the immediate status of the designated outputs. The status is displayed as an 8-bit binary number with output 1 in the far right position (bit 0). With a parameter this command sets the outputs high or low using the decimal equivalent of the same binary pattern. Logic zero ("0") turns an output on by closing it.

### Command Details:

Structure	IO{Parameter #1}
Type	IMMEDIATE
Usage	READ/WRITE
Non-Volatile	NO
Register Access	None

### Parameter Details:

(See Appendix F: Working With Inputs and Outputs)

### Examples:

#### BLu and STAC6-S or -Q versions (optional "Y" character is not necessary)

Command	Drive sends	Notes
IO	IO=00000000	All 3 outputs of IN/OUT1 or main board are low (closed)
IO	IO=00000111	All 3 outputs of IN/OUT1 or main board are high (open)
IO0	-	Sets all 3 outputs low (closed)
IO7	-	Sets all 3 outputs high (open)

#### BLu and STAC6-QE or -Si versions

Command	Drive sends	Notes
IO	IO=00000000	All 4 outputs of IN/OUT2 or top board are low (closed)
IO	IO=00001111	All 4 outputs of IN/OUT2 or top board are high (open)
IO0	-	Sets all 4 outputs of IN/OUT2 or top board low (closed)
IO15	-	Sets all 4 outputs of IN/OUT2 or top board high (open)
IOY	IO=00000000	All 3 outputs of IN/OUT1 or main board are low (closed)
IOY	IO=00000111	All 3 outputs of IN/OUT1 or main board are high (open)
IOY0	-	Sets all 3 outputs of IN/OUT1 or main board low (closed)
IOY7	-	Sets all 3 outputs of IN/OUT1 or main board high (open)

#### STAC5-S, SVAC3-S

Command	Drive sends	Notes (DB-15)
IOY	IO=00000000	Both outputs of IN/OUT1 are low (closed)
IOY	IO=00000011	Both outputs of IN/OUT1 are high (open)
IOY0	-	Sets both outputs of IN/OUT1 low (closed)
IOY3	-	Sets both outputs of IN/OUT1 high (open)



**STAC5-Q/IP, SVAC3-Q/IP**

Command	Drive sends	Notes (DB25)
IO	IO=00000000	All 4 outputs of IN/OUT2 are low (closed)
IO	IO=00001111	All 4 outputs of IN/OUT2 are high (open)
IO0	-	Sets all 4 outputs of IN/OUT2 low (closed)
IO15	-	Sets all 4 outputs of IN/OUT2 high (open)
IO	IO=00001111	All 4 outputs of IN/OUT2 high (open)
		Notes (DB15)
IOY	IO=00000000	Both outputs of IN/OUT1 low (closed)
IOY	IO=00000011	Both outputs of IN/OUT1 high (open)
IOY0	-	Both outputs of IN/OUT1 low (closed)
IOY7	-	Both outputs of IN/OUT1 high (open)

**SV, ST-Q/Si**

Command	Drive sends	Notes
IO	IO=00000000	All 4 outputs are low (closed)
IO	IO=00001111	All 4 outputs are high (open)
IO0	-	Sets all 4 outputs low (closed)
IO7	-	Sets all 4 outputs high (open)

**ST-S, STM17-S/Q/C, STM23-Q/C, STM24-C**

Command	Drive Sends	Notes
IO	IO=00000000	Output is low (closed)
IO	IO=00000001	Output is high (open)
IO0	-	Sets output low (closed)
IO1	-	Sets output high (open)

**STM24 – Flex I/O**

Command	Drive sends	Notes
IO	IO=00000000	All 4 outputs of IN/OUT2 are low (closed)
IO	IO=00001111	All 4 outputs of IN/OUT2 are high (open)
IO0	-	Sets all 4 outputs of IN/OUT2 low (closed)
IO15	-	Sets all 4 outputs of IN/OUT2 high (open)
IO	IO=00001111	All 4 outputs of IN/OUT2 high (open)

---

## IP - Immediate Position

---

Compatibility: All drives

Requests present absolute position. This is the calculated trajectory position, which is not always equal to actual position. The position data is assigned a 32-bit value. When sent out in Hexadecimal it will be 8 characters long. When sent out in decimal it will range from 2147483647 to -2147483648.

### Command Details:

Structure	IP
Type	IMMEDIATE
Usage	READ ONLY
Non-Volatile	NO
Register Access	None
Units	encoder counts (servo) steps (stepper)

### Examples:

Command	Drive sends	Notes
IP	IP=00002710	Absolute position is 10,000 counts (or steps)
IP	IP=FFFFD8F0	Absolute position is -10,000 counts (or steps)

If the IF command is set with Parameter #1=D

IP	IP=10000	Absolute position is 10000 counts (or steps)
IP	IP=-10000	Absolute position is -10000 counts (or steps)

---

## IQ - Immediate Current (Actual)

---

Compatibility: Servo drives only

Requests present actual current. This current reading is the actual current measured by the drive. As with the Commanded Current this is an RMS value that represents the DC current in the motor windings.

### Command Details:

Structure	IQ
Type	IMMEDIATE
Usage	READ ONLY
Non-Volatile	NO
Register Access	None
Units	0.01 Amps

### Examples:

Command	Drive sends	Notes
IQ	IQ=015E	3.5 Amps
IQ	IQ=FEA2	-3.5 Amps

If the IF command is set with Parameter #1=D

IQ	IQ=350	3.5 Amps
IQ	IQ=-350	-3.5 Amps

## IS - Input Status

Compatibility: All drives

Requests immediate status of all drive inputs. A closed input is represented by a “0” (zero), and an open input is represented by a “1” (one). Unused positions in the response are represented by “0” (zero).

### BLu, STAC6

On S and Q drives the IS command requests the status of IN/OUT1 or main driver board (DB-25) inputs X1 through X7 plus the encoder index channel (if present). On SE, QE, and Si drives the ISX command (IS command with parameter character X) is required to request status of IN/OUT1 or main driver board (DB-25) inputs X1 through X7 plus the encoder index channel (if present), while IS requests IN/OUT2 or top board (screw terminal) inputs 1 through 8.

### SV, ST-Q/Si

The IS command requests the status of inputs X1 through X8 plus the encoder index channel (if present).

### ST-S, STM17-S/Q/C, STM23-Q/C, STM24-C

The IS command requests the status of all three digital inputs, STEP, DIR, and EN, plus the encoder index channel (STM only, if present).

### STM17-C, STM24-C

The IS command requests the status of all three digital inputs, IN1, IN2, and IN3, plus the encoder index channel, if present.

### SSM/TSM/TXM

The IS command request the status of all inputs plus the encoder index channel.

### SS

The IS command requests the status of inputs X1 - X8 plus the encoder index channel.

### SV200

The IS command requests the status of inputs X1 - X12 plus the encoder index channel.

## Command Details:

Structure	IS{Parameter #1}
Type	IMMEDIATE
Usage	READ ONLY
Non-Volatile	NO
Register Access	None

## Parameter Details:

### BLu, STAC6

Parameter #1	Optional “X” character used to access driver board inputs with SE, QE, and Si drives.
--------------	---

### SV, ST-Q/Si, ST-S, STM17-S/Q/C, STM23-Q/C, STM24-C

Parameter #1	“X” character ignored if used.
--------------	--------------------------------

SVAC3, STAC5

Parameter #1	Optional "X" character used to access driver board inputs with Q and IP drives.
--------------	---

Response Details:

BLu, STAC6

**S and Q drives**

("X" character is not required to designate main board inputs)

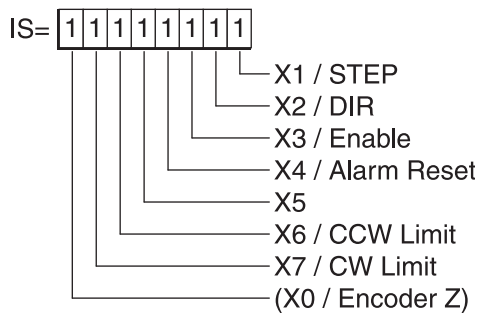

**SE, QE, and Si drives**

("X" character is required to designate main board inputs)

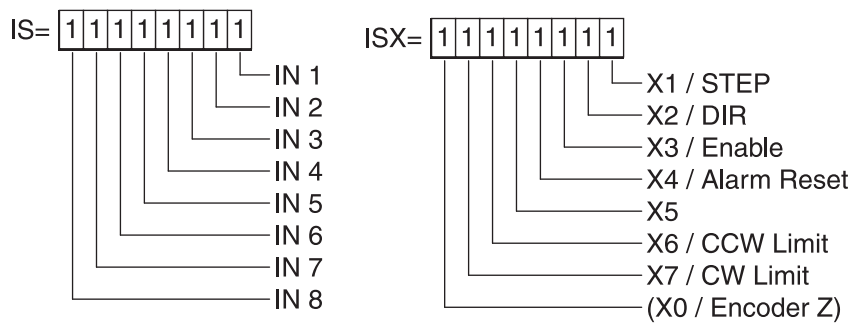

SV, ST-Q/Si

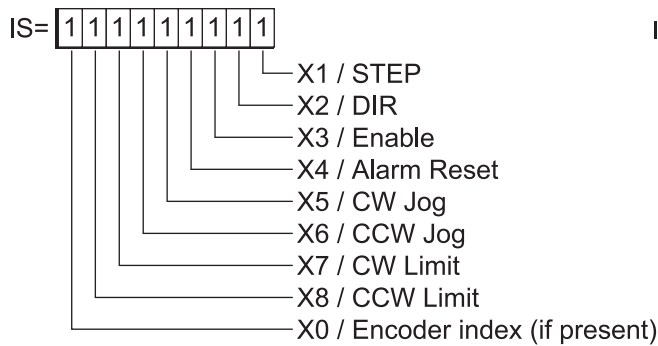

ST-S, STM17-S/Q/C, STM23-Q/C, STM24

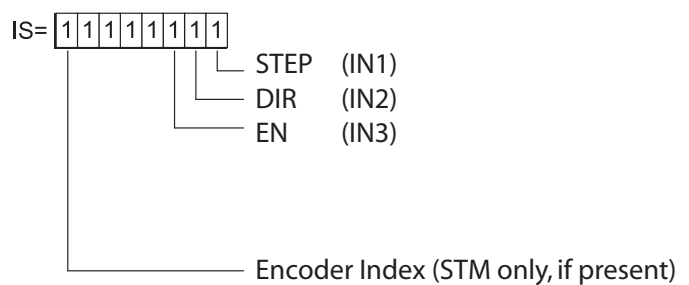

SVAC3, STAC5

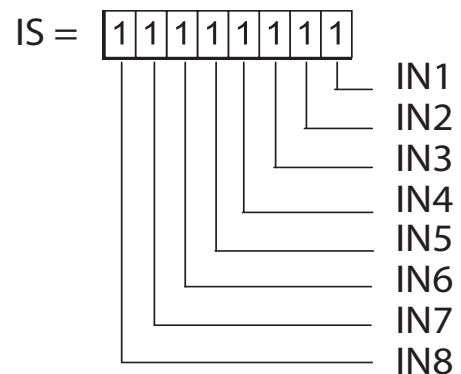
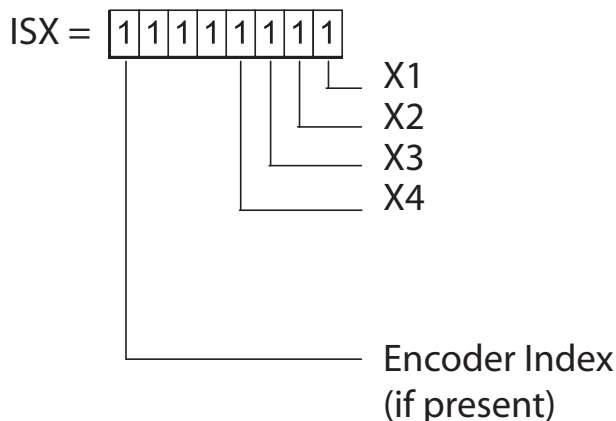

## Examples:

BLu and STAC6-S or -Q versions (optional “X” character is not necessary)

Command	Drive sends	Notes
IS	IS=00000000	All 8 inputs are low (closed)
IS	IS=11111111	All 8 inputs are high (open)
IS	IS=11101100	Inputs 1, 2, and 5 are closed
IS	IS=10000101	Inputs 2, 4, 5, 6, and 7 are closed

BLu and STAC6-SE, -QE, or -Si versions (optional “X” character necessary to access IN/OUT1 or main driver board (DB-25) inputs)

Command	Drive sends	Notes
IS	IS=11010011	Inputs 3, 4, and 6 are closed
ISX	IS=10101110	Inputs X1, X5, and X7 are closed

SV, ST-Q/Si

Command	Drive sends	Notes
IS	IS=100110110	Inputs 1, 4, 7, and 8 are closed
IS	IS=011111111	Encoder index channel is closed

ST-S, STM17-S/Q/C, STM23-Q/C, STM24-C

Command	Drive Sends	Notes
IS	IS=10000111	All inputs are open
IS	IS=00000111	Encoder index channel is closed
IS	IS=10000100	Inputs STEP and DIR are closed

SVAC3, STAC5

Command	Drive Sends	Notes
IS	IS=10001111	(S drive) No inputs are closed.
IS	IS=10001111	(Q or IP drive) Inputs IN5 - IN7 are closed.
IS	IS=00000111	(S drive) Encoder index and input X4 are closed.
IS	IS=00000111	(Q or IP drive) Inputs IN4 - IN8 are closed.
IS	IS=10101110	(S drive) <i>Invalid response.</i>
IS	IS=10101110	(Q or IP drive) Inputs IN1, IN5 and IN7 are closed.
ISX	IS=10001010	Inputs X1 and X3 are closed.

**NOTE:** When working with digital inputs and outputs it is important to remember the designations **low** and **high**. If current is flowing into or out of an input or output, i.e. the circuit is energized, the logic state for that input/output is defined as **low** or closed. If no current is flowing, i.e. the circuit is de-energized, or the input/output is not connected, the logic state is **high** or open. A low state is represented by the “L” character in parameters of commands that affect inputs/outputs. For example, WI3L means “wait for input 3 low”, and SO1L means “set output 1 low”. A high state is represented by the “H” character.

## IT - Immediate Temperature

Compatibility: All drives

Requests drive temperature, as measured by either an on-chip or board-mounted sensor. A parameter of 0 or 1 is used to specify which temperature reading is desired, depending on drive type (see Parameter Details).

The temperature reads out in decivolts, or units of 0.1 degrees C. The drive will fault when the temperature reaches a specified maximum value. (See Parameter Details section below for details).

If no parameter is supplied, IT0 is assumed.

### Command Details:

Structure	IT {Parameter #1}
Type	IMMEDIATE
Usage	READ ONLY
Non-Volatile	NO
Register Access	"t" (068)
Range	0 - 1
Units	0.1 deg C

### Parameter Details:

#### BLu, STAC6, STM17

Parameter #1	Optional. IT or IT0 returns the temperature as measured by an external, board-mounted sensor.  Overtemp occurs at 85 degrees C.
--------------	---

#### ST

Parameter #1	Optional. IT or IT0 returns the temperature as measured by the internal, on-chip sensor.  Overtemp occurs at 85 degrees C.
--------------	--

#### SV7

Parameter #1	Optional. IT or IT0 returns the temperature as measured by the internal, on-chip sensor.  Overtemp occurs at 100 degrees C.
--------------	---

#### STM23, STM24

Parameter #1	0 = Returns the temperature as measured by the internal, on-chip sensor.  1 = Returns the temperature as measured by an external, board-mounted sensor.  Overtemp occurs at 85 degrees C.
--------------	---

SVAC3, STAC5

Parameter #1	0 = Returns the temperature as measured by an external, board-mounted sensor. Overtemp occurs at 85 degrees C.  1 = Returns the temperature as measured by the internal, on-chip sensor. Overtemp occurs at 100 degrees C.
--------------	--

Examples:

Command	Drive sends	Notes
IT	IT=275	Drive temperature is 27.5° C
IT0	IT=310	Drive temperature is 31.0° C
IT1	IT=412	Drive temperature is 41.2° C



## IU - Immediate Voltage

Compatibility: All drives

Requests present value of the DC bus voltage, +/-5%. The voltage reads out in 0.1 volts resolution. The drive will fault when the DC bus voltage reaches a specified maximum value. An Alarm will be set when the DC Bus voltage is less than a minimum value. (See hardware manuals for details).

### Command Details:

Structure	IU
Type	IMMEDIATE
Usage	READ ONLY
Non-Volatile	NO
Register Access	"u" (069)
Units	0.1 Volts DC, +/-5%

### Examples:

Command	Drive sends	Notes
If the IF command is set with Parameter #1=H		
IU	IU=01E2	DC supply voltage is 48.2 Volts
IU	IU=067E	DC bus voltage is 166.2 Volts
If the IF command is set with Parameter #1=D		
IU	IU=482	DC supply voltage is 48.2 Volts
IU	IU=1662	DC bus voltage is 166.2 Volts

## IV - Immediate Velocity

Compatibility: All drives

Requests present velocity of the motor in rpm. There are two different velocities that can be read back: the motor's actual velocity and the motor's target velocity.

### Command Details:

Structure	IV(Parameter #1)
Type	IMMEDIATE
Usage	READ ONLY
Non-Volatile	NO
Register Access	"v" (070) Actual velocity (servo drives and stepper drives with encoder) "w" (071) Target velocity

### Parameter Details:

Parameter #1	Velocity selector
- units	integer
- range	0 = actual velocity request (servo drives and stepper drives with encoder) 1 = target velocity request

### Examples:

Command	Drive sends	Notes
IV0	IV=1000	Servo motor is running at 1000 rpm
IV1	IV=1000	Target motor velocity is 1000 rpm

---

## IX - Immediate Position Error

---

Compatibility: Servo drives and stepper drives with encoder feedback

Requests present position error between motor and encoder.

### Command Details:

Structure	IX
Type	IMMEDIATE
Usage	READ ONLY
Non-Volatile	NO
Register Access	"x" (072)
Units	encoder counts

### Examples:

Command	Drive sends	Notes
IX	IX=10	Position error is 10 counts

## JA - Jog Acceleration

Compatibility: All drives  
 Affects: CJ, WI (jogging) commands  
 See also: CJ, CS, JD, JE, JL, JS, SJ

Sets or requests the accel/decel rate for Jog moves in rev/sec/sec. Sending JA with no parameter causes drive to respond with present jog accel/decel rate. Setting JA overwrites the both the last JA and JL values. This means that to have different jog accel and jog decel values, you should first send JA to set the jog accel and then send JL to set the jog decel. The JA value cannot be changed while jogging.

### Command Details:

Structure	JA{Parameter #1}
Type	BUFFERED
Usage	READ/WRITE
Non-Volatile	Yes
Register Access	None

### Parameter Details:

Parameter #1	Jog acceleration value
- units	rev/sec/sec (rps/s)
- range	0.167 to 5461.167 (resolution is 0.167 rps/s)

### Examples:

Command	Drive sends	Notes
JA100	-	Set jog acceleration to 100 rev/sec/sec
JA	JA=100	

## JC - Velocity (Oscillator) mode second speed

Compatibility: Stepper drives and SV servo drives  
 Affects: Analog velocity mode  
 See also: AD, AG, CM commands

Sets or requests the second speed used in velocity (oscillator) mode. This only applies to Command Modes (CM) 13, 14, 17, and 18.

### SV, STAC6, ST-Q/Si

Input X5 is used to select the speed set by the JC command while in Command Mode 13, 14, 17 or 18.

### ST-S, STM

The EN input is used to select the speed set by the JC command while in Command Mode 13, 14, 17 or 18.

### Command Details:

Structure	JC{Parameter #1}
Type	BUFFERED
Usage	READ/WRITE
Non-Volatile	YES
Register Access	None

### Parameter Details:

Parameter #1	Analog velocity mode second speed
- units	rev/sec
- range	BLu, SV, STAC6, ST-Q/Si, ST-S: 0.0042 - 133.3333 (resolution is 0.0042) STM: 0.0042 - 80.0000 (resolution is 0.0042)

### Examples:

Command	Drive sends	Notes
JC11	-	Set second jog speed in analog velocity mode to 11 rps
JC	JC=11	

## JC - 8 Jog Velocities (SV200 drives)

Compatibility: SV200 drives  
Affects: Control mode 15,16,17,18

Sets or requests the speed used in velocity mode. This only applies to control modes 15, 16, 17, and 18. The command has two parameters: the first parameter selects the velocity number (1-8); the second parameter sets the velocity value of the selected velocity number. See *SVX Servo Suite* software.

### Command Details:

Structure	JC{Parameter #1}{Parameter #2}
Type	BUFFERED
Usage	READ/WRITE
Non-Volatile	YES
Register Access	NO

### Parameter Details:

Parameter #1	The velocity number
- units	integer number
- range	1~8
Parameter #2	Jog velocity
- units	rps
- range	1~136

### Examples:

Command	Drive sends	Notes
JC110	%	Set the first jog velocity to 10rps
JC1	JC1 =10	The first jog velocity is 10rps

---

## JD - Jog Disable

---

Compatibility: All drives  
 Affects: Jogging during a WI command  
 See also: JA, JE, JS, WI commands

Disables jog inputs (which are active during a WI instruction if previously enabled by the JE command). Jog accel/ decel and velocity are set using the JA and JS commands, respectively.

### Command Details:

Structure	JD
Type	BUFFERED
Usage	WRITE ONLY
Non-Volatile	NO
Register Access	None

### Examples:

Command	Drive sends	Notes
JD	-	Disable jog inputs while executing the WI command

## JE - Jog Enable

Compatibility: All drives  
 Affects: WI (jogging) command  
 See also: JA, JD, JS, WI commands

Enables jog inputs during a WI instruction. Jog accel, decel and velocity are set using the JA, JD and JS commands, respectively.

### BLu, STAC6-S, SE, Q, QE

Inputs X1 and X2 are the designated jog inputs during a WI instruction.

### BLu, STAC6-Si

Inputs 5 and 6 of IN/OUT2 or top board (screw terminal) connector are the designated jog inputs during a WI instruction.

### SV, ST-Q/Si

Inputs X5 and X6 are the designated jog inputs during a WI instruction.

### ST-S, STM

The STEP and DIR inputs are the designated jog inputs during a WI instruction. The STEP and DIR inputs can each be assigned to only one function in an application. If you want to use the STEP and DIR inputs as jog inputs you can define them as such with the JE command. JE takes no effect if the drive is set in Command Mode (CM) 7, 11, 12, 13, 14, 15, 16, 17 or 18, because these modes predefine these inputs and take precedence over the JE command. Also, setting the DL command (to 1 or 2) after setting the JE command reassigns the STEP and DIR inputs as end-of-travel limit inputs and turns off jogging functionality. In other words, the JE and DL commands, as well as Command Modes (CM) 7, 11, 12, 13, 14, 15, 16, 17 and 18 each assign a usage to the STEP and DIR inputs. Each of these must exclusively use the STEP and DIR inputs. Command Modes are most dominant and will continually prevent JE and DL from using the inputs. JE and DL exclude each other by overwriting the usage of the STEP and DIR inputs. To enable jogging with the STEP and DIR inputs simply execute the JE command with CM=21 or CM=22.

## Command Details:

Structure	JE
Type	BUFFERED
Usage	WRITE ONLY
Non-Volatile	NO
Register Access	None

## Examples:

Command	Drive sends	Notes
JE	-	Enable jog inputs while executing the WI command
WIX4L	-	Wait for input X4 to close. While waiting jog inputs are active, which means the motor can be jogged in the CW and CCW directions by closing the jog inputs. After input X4 closes the jog function stops, at least until the next WI command executes.



## JL - Jog Decel

Compatibility: All drives  
 Affects: Jogging during WI command, velocity (oscillator) modes, and CJ command  
 See also: JA command

Sets or requests the decel rate for Jog moves and velocity (oscillator) modes in rev/sec/sec. The JL value cannot be changed while jogging. To maintain compatibility with legacy products, JA sets both the JA and JL values, so when a different JL value is required set JA first, then set JL.

### Command Details:

Structure	JL{Parameter #1}
Type	BUFFERED
Usage	READ/WRITE
Non-Volatile	YES
Register Access	None

### Parameter Details:

Parameter #1	Jog deceleration rate
- units	rev/sec/sec (rps/s)
- range	0.167 - 5461.167 rps/s (resolution is 0.167 rps/s)

### Examples:

Command	Drive sends	Notes
JL25	-	Sets jog deceleration rate to 25 rps/s
JL	JL=25	

## JM - Jog Mode

Compatibility: All drives\*, see below  
 Affects: CJ command, and jogging during a WI command  
 See also: CJ, JE, WI commands

Sets or requests the Jog mode. There are two Jog modes available:

\*Stepper drives only utilize Jog Mode 1 (JM1), and therefore will ignore attempts to set JM2.

### Jog Mode 1: Servo and stepper drives

For servo drives, Jog Mode 1 uses a “position-type” of servo control that moves the target position which causes the servo to move at the set velocity. Jog Mode 1 will cause the servo motor to always move the same distance over time. A drawback is that the servo can fault if the position error during the move exceeds the value set by the PF (Position Fault) command. For stepper drives, Jog Mode 1 causes the step motor to run at the set velocity (see JS and CS commands).

### Jog Mode 2: Servo drives only

For servo drives only, Jog Mode 2 uses a “velocity-type” of servo control that applies torque to the motor to maintain velocity. This method functions better with high inertia loads because it ignores the value set by the PF (Position Fault) command. It also allows the drive to function in a “torque-limited velocity” mode or a “velocity-limited torque” mode. Jog Mode 2 also uses a different set of control parameters, VI and VP, for “tuning” the velocity mode. See VI & VP commands later in this guide.

## Command Details:

Structure	JM{Parameter #1}
Type	BUFFERED
Usage	READ/WRITE
Non-Volatile	YES
Register Access	None

## Parameter Details:

Parameter #1	Jog mode
- units	integer
- range	1 = position-type 2 = velocity-type

## Examples:

Command	Drive sends	Notes
JM1	-	Put drive into position-type servo control when jogging
JM2	-	Put drive into velocity-type servo control when jogging
JM	JM=2	

## JS - Jog Speed

Compatibility: All drives  
 Affects: Jogging during WI command, velocity (oscillator) modes, and CJ command  
 See also: CJ, CS, JA commands

Sets or requests the speed for Jog moves in rev/sec. Sending JS with no parameter causes drive to respond with present jog speed.

### Command Details:

Structure	JS{Parameter #1}
Type	BUFFERED
Usage	READ/WRITE
Non-Volatile	Yes
Register Access	“J” (026) Note: The JS command uses different units than the “J” register. See Data Registers section for details.

### Parameter Details:

Parameter #1	Move velocity
- units	rev/sec
- range	BLu, SV, STAC6, ST-Q/Si, ST-S: 0.0042 - 133.3333 (resolution is 0.0042) STM: 0.0042 - 80.0000 (resolution is 0.0042)

### Examples:

Command	Drive sends	Notes
JS10.35	-	Set jog speed to 10.35 rps
JS	JS=10.35	

---

## KC - Overall Servo Filter

---

Compatibility: Servo drives only  
 Affects: Servo tuning and performance

Sets or requests the servo control overall filter frequency. The filter is a simple one-pole, low-pass filter intended for attenuating high frequency oscillations. The value is a constant that must be calculated from the desired roll off frequency. See equation below.

*NOTE: It is recommended to use the Quick Tuner software for tuning and configuring your servo system.*

$$C = 72090 / (1400/F + 2.2)$$

where C = Filter Value, F = desired filter Frequency in Hz

### Command Details:

Structure	KC{Parameter #1}
Type	BUFFERED
Usage	READ/WRITE
Non-Volatile	Yes
Register Access	None

### Parameter Details:

Parameter #1	Filter Value
- units	integer
- range	0 - 32767 (see above for calculations)

### Examples:

Command	Drive sends	Notes
KC7836	-	Set servo filter to 200 Hz
KC	KC=7836	

## KD - Differential Constant

Compatibility: Servo drives only  
 Affects: Servo tuning and performance

Sets or requests the servo control differential gain. Gain value is relative: “0” meaning no gain, “32767” meaning full gain. KD is part of the Damping servo parameters in *Quick Tuner*. It works to damp low speed oscillations.

*NOTE: It is recommended to use the Quick Tuner software for tuning and configuring your servo system.*

### Command Details:

Structure	KD{Parameter #1}
Type	BUFFERED
Usage	READ/WRITE
Non-Volatile	Yes
Register Access	None

### Parameter Details:

Parameter #1	Differential Gain value
- units	integer
- range	0 - 32767 (0 = 0%, 32767 = 100%)

### Examples:

Command	Drive sends	Notes
KD2000	-	Set differential gain to 2000
KD	KD=2000	

## KE - Differential Filter

Compatibility: Servo drives only  
 Affects: Servo tuning and performance

Sets or requests the differential control parameter filter frequency. The filter is a simple one-pole, low-pass filter intended for attenuating high frequency oscillations. The value is a constant that must be calculated from the desired roll off frequency. See equation below.

$$C = 72090 / (1400/F + 2.2)$$

where C = Filter Value, K = desired filter Frequency in Hz

*NOTE: It is recommended to use the Quick Tuner software for tuning and configuring your servo system.*

### Command Details:

Structure	KE{Parameter #1}
Type	BUFFERED
Usage	READ/WRITE
Non-Volatile	Yes
Register Access	None

### Parameter Details:

Parameter #1	Filter Value
- units	integer
- range	0 - 32767

### Examples:

Command	Drive sends	Notes
KE7836	-	Set differential filter to 200 Hz

## KF - Velocity Feedforward Constant

Compatibility: Servo drives only  
 Affects: Servo tuning and performance

Sets or requests the servo control velocity feedforward gain. Gain value is relative: “0” meaning no gain, “32767” meaning full gain. KF is part of the Damping servo parameters in *Quick Tuner*. It counters the effects of the KV parameter which can cause large following error. KF is usually the same value as KV.

*NOTE: It is recommended to use the Quick Tuner software for tuning and configuring your servo system.*

### Command Details:

Structure	KF{Parameter #1}
Type	BUFFERED
Usage	READ/WRITE
Non-Volatile	Yes
Register Access	None

### Parameter Details:

Parameter #1	Velocity feedforward gain value
- units	integer
- range	0 - 32767 (0 = 0%, 32767 = 100%)

### Examples:

Command	Drive sends	Notes
KF4000	-	Set velocity feedforward gain to 4000
KF	KF=4000	

---

## KG – Secondary Global Gain

---

Compatibility: SV200 series servo drives only  
 Affects: Servo tuning and performance  
 See also: KP, GG commands

Sets or requests the secondary global gain of PID controller. This is the proportional gain in the position loop and an alternate to KP. See GG command (and SVX Servo Suite software for details on switching between KP and KG with the X7 digital input).

### Command Details:

Structure	KG{Parameter #1}
Type	BUFFERED
Usage	READ/WRITE
Non-Volatile	YES
Register Access	NO

### Parameter Details:

Parameter #1	Global gain
- units	integer number
- range	0~32767

### Examples:

Command	Drive sends	Notes
KG10000	%	Set the secondary global gain to 10000
KG	KG =10000	The secondary global gain is 10000



## KI - Integrator Constant

Compatibility: Servo drives only  
 Affects: Servo tuning and performance

Sets or requests the servo control integrator gain term. Gain value is relative: “0” meaning no gain, “32767” meaning full gain. KI is part of the Stiffness servo parameters in *Quick Tuner*. It minimizes (or may even eliminate) position errors especially when holding position.

*NOTE: It is recommended to use the Quick Tuner software for tuning and configuring your servo system.*

### Command Details:

Structure	KI{Parameter #1}
Type	BUFFERED
Usage	READ/WRITE
Non-Volatile	Yes
Register Access	None

### Parameter Details:

Parameter #1	Integrator gain value
- units	integer
- range	0 - 32767 (0 = 0%, 32767 = 100%)

### Examples:

Command	Drive sends	Notes
KI5000	-	Set integrator gain to 500
KI	KI=500	

## KJ - Jerk Filter Frequency

Compatibility: SV200 series, SV7 and SVAC3 Servo drives only  
 Affects: S-Curve

Sets or requests the Jerk Filter frequency, in Hz. The parameter is set within *SVX Servo Suite* for SV200 drives and *Quick Tuner* for SV7 and SVAC3 drives; it can also be set with the SCL command KJ. The lower the frequency value the more pronounced the S-curve profile will be. Setting the value to 0 will disable the filter.

S-curve acceleration/deceleration ramps are beneficial in positioning systems where instantaneous changes in speed may cause the load to jerk excessively. One example is when the load is connected to the motion actuator via a long moment arm. If the arm is not sufficiently rigid, changes in speed at the actuator can result in undesirable oscillations and increased settling time at the load. Smoothed transitions in speed changes, such as those provided by the jerk filter can alleviate this unwanted motion and reduce settling time.

*NOTE: It is recommended to use the software for tuning and configuring your servo system.*

### Command Details:

Structure	KJ{Parameter #1}
Type	BUFFERED
Usage	READ/WRITE
Non-Volatile	Yes
Register Access	None

### Parameter Details:

Parameter #1	Jerk Filter Frequency (Hz)
- units	integer
- range	0 - 5000 (0 = disabled)

### Examples:

Command	Drive sends	Notes
KJ500	-	Set jerk filter frequency to 500Hz
KJ	KJ=500	

## KK - Inertia Feedforward Constant

Compatibility: Servo drives only  
 Affects: Servo tuning and performance

Sets or requests the servo control inertia feedforward gain. Gain value is relative: “0” meaning no gain, “32767” meaning full gain. KK is an Inertia servo parameter in *Quick Tuner*. KK improves acceleration control by compensating for the load inertia.

*NOTE: It is recommended to use the Quick Tuner software for tuning and configuring your servo system.*

### Command Details:

Structure	KK{Parameter #1}
Type	BUFFERED
Usage	READ/WRITE
Non-Volatile	Yes
Register Access	None

### Parameter Details:

Parameter #1	Inertia feedforward gain value
- units	integer
- range	0 - 32767 (0 = 0%, 32767 = 100%)

### Examples:

Command	Drive sends	Notes
KK500	-	Set inertia feedforward gain to 500
KK	KK=500	

## KP - Proportional Constant

Compatibility: Servo drives only  
 Affects: Servo tuning and performance

Sets or requests the servo control proportional gain term. Gain value is relative: “0” meaning no gain, “32767” meaning full gain. KP is part of the Stiffness servo parameters in *Quick Tuner*. This parameter is the primary gain term for minimizing the position error.

*NOTE: It is recommended to use the Quick Tuner software for tuning and configuring your servo system.*

### Command Details:

Structure	KP{Parameter #1}
Type	BUFFERED
Usage	READ/WRITE
Non-Volatile	Yes
Register Access	None

### Parameter Details:

Parameter #1	Proportional gain value
- units	integer
- range	0 - 32767 (0 = 0%, 32767 = 100%)

### Examples:

Command	Drive sends	Notes
KP5000	-	Set proportional gain to 5000
KP	KP=5000	

## KV - Velocity Feedback Constant

Compatibility: Servo drives only  
 Affects: Servo tuning and performance

Sets or requests the servo control velocity feedback gain term. Gain value is relative: “0” meaning no gain, “32767” meaning full gain. KV is part of the Damping servo parameters in *Quick Tuner*. It aids the KD command in damping system oscillation. This term helps to control larger inertial loads.

*NOTE: The Velocity Feedback (KV) and Velocity Feedforward (KF) constants are typically set to similar values. The Feedforward value may at times be set larger depending on the frictional content of the motor load.*

*NOTE: It is recommended to use the Quick Tuner software for tuning and configuring your servo system.*

### Command Details:

Structure	KV{Parameter #1}
Type	BUFFERED
Usage	READ/WRITE
Non-Volatile	Yes
Register Access	None

### Parameter Details:

Parameter #1	Velocity feedback gain value
- units	integer
- range	0 - 32767 (0 = 0%, 32767 = 100%)

### Examples:

Command	Drive sends	Notes
KV4000	-	Set velocity feedback gain to 4000
KV	KV=4000	

## LA - Lead Angle Max Value

Compatibility: Stepper drives (except STM)  
See also: EF, LS commands

Returns the maximum lead angle setting for use in the Stall Prevention algorithm (see EF command for details). This value is reached at the speed set by the LS command.

Lead Angle is the angular measurement between the internal magnetic field and the motor's rotor. If the lead angle is too large, the magnetic attraction fades and the motor will stall. Too small of a value makes inefficient use of the magnetic attraction and the motor will not produce its maximum torque.

Lead angle directly affects the magnetic forces acting on the rotor, and is thus directly related to the motor's torque. An ideal setting for Lead Angle is essential for maximizing the motor's torque output. During motion, the motor's lead angle is constantly monitored and adjusted to keep it within a speed-dependent operational range and allow the drive to maintain control of the motor even in the event of a disturbance. The maximum lead angle (set by LA) is reached at the Lead Angle Speed specified by LS.

This value is measured in *electrical degrees*. There are four physical motor steps ( $4 * 1.8 \text{ degrees} = 7.2 \text{ degrees}$ ) per 360 degree electrical cycle.

The relationship between electrical degrees and motor rotational displacement is given as follows:

$$\begin{aligned} &360 \text{ electrical degrees} / 7.2 \text{ rotational degrees} \\ &50 \text{ electrical degrees} / \text{rotational degree} \end{aligned}$$

Alternatively, in terms of physical displacement,

$$\begin{aligned} &1 \text{ rotational degree} / 50 \text{ electrical degrees} \\ &0.02 \text{ rotational degrees} / \text{electrical degree} \end{aligned}$$

The maximum effective setting for LA is 180 electrical degrees. If at any point the motor's lead angle exceeds this value, a stall condition will occur.

*NOTE: While it is worthwhile to understand the meaning of the Lead Angle setting, it is intended that the ST Configurator software be used to configure this setting.*

### Command Details:

Structure	LA{Parameter #1}
Type	BUFFERED
Usage	READ / WRITE
Non-Volatile	YES
Register Access	None

### Parameter Details:

Parameter #1	Lead Angle Value
- units	integer
- range	1 - 180 electrical degrees

## Examples:

Command	Drive sends	Notes
LA120	-	Set the target lead angle setting to 120 electrical degrees (default, optimal for most motors)
LA	LA=120	

## LM - Software Limit CCW

Compatibility: SSM, TSM, TXM, SS, SSAC and SV200 series servo drives  
 See also: SP and AM commands

Sets or requests software CCW limit values.

Motor decelerates to stop when the absolute position (can be requested or set by SP command) decreases to software CCW limit value, Software limit does not work in CCW direction when software CCW limit parameter is set to zero. This parameter is volatile and the default value will be zero upon power-up.

### Command Details:

Structure	LM{Parameter #1}
Type	BUFFERED
Usage	READ / WRITE
Non-Volatile	NO
Register Access	NO

### Parameter Details:

Parameter #1	Software Limit Value
- units	Absolute position
- range	+/- 2,147,483,647

### Examples:

Command	Drive sends	Notes
LM10000	%	Set software CCW limit value to 10000 counts.
LM	LM =10000	Request software CCW limit value.
LM0	%	Turn off software limit function in CCW direction.



## LP - Software Limit CW

Compatibility: SSM, TSM, TXM, SS, SSAC and SV200 series servo drives  
 See also: SP and AM commands

Sets or requests software CW limit values.

Motor decelerates to stop when the absolute position (can be requested or set by SP command) increases to software CW limit value. Software limit does not work in CW direction when software CW limit parameter is set to zero. This parameter is volatile and the default value is zero when power-up.

### Command Details:

Structure	LP{Parameter #1}
Type	BUFFERED
Usage	READ / WRITE
Non-Volatile	NO
Register Access	NO

### Parameter Details:

Parameter #1	Software Limit Value
- units	Absolute position
- range	+/- 2,147,483,647

### Examples:

Command	Drive sends	Notes
LP10000	%	Set software CW limit value to 10000 counts.
LP	LP =10000	Request software CW limit value.
LP0	%	Turn off software limit function in CW direction

---

## LS - Lead Angle Speed

---

Compatibility: Stepper drives (except STM)  
 See also: EF, LA commands

Specifies the speed at which the Lead Angle specified by the LA command will be applied. (See LA command for a detailed description of the Lead Angle concept.)

During operation, the lead angle is continuously monitored and is dynamically adjusted to maintain maximum torque output. The optimal setting is dependent upon motor speed, with the maximum setting occurring at the speed specified by LS.

*NOTE: While it is worthwhile to understand the meaning of the Lead Angle Speed setting, it is intended that the ST Configurator software be used to configure this setting.*

### Command Details:

Structure	LS{Parameter #1}
Type	BUFFERED
Usage	READ / WRITE
Non-Volatile	YES
Register Access	None

### Parameter Details:

Parameter #1	Lead Angle Speed
- units	integer
- range	1 - 80 rev/sec

### Examples:

Command	Drive sends	Notes
LS25	-	Use maximum lead angle setting (LA) at 25 rps
LS	LS=25	

## LV - Low Voltage threshold

Compatibility: All drives  
Affects: Under voltage alarm and fault

Sets or requests the low voltage threshold for under voltage alarm / fault conditions. In AC drives (e.g. BLuAC5 and STAC6) an under voltage condition causes a Drive Fault, which disables the motor outputs of the drive. In DC drives (SV, ST, and STM) an under voltage condition causes an Alarm. If desired, the user can change the low voltage threshold of the drive, however in most applications it is neither necessary nor recommended. The factory default for low voltage threshold is set to both protect the drive from damage and work with the widest range of supply voltages possible.

### Command Details:

Structure	LV{Parameter #1}
Type	BUFFERED
Usage	READ/WRITE
Non-Volatile	Yes
Register Access	None

### Parameter Details:

Parameter #1	Low voltage threshold
- units	All drives except BLuAC5: 0.1 volts DC BLuAC5: 1 volt DC
- range	BLuDC: 18 to 40 BLuAC: 90 to 300 STAC6: 90 to 160 ST5: 12 to 75 ST10: 12 to 75 SV7: 12 to 75 STM: 10 to 75

### Examples:

Command	Drive sends	Notes
LV	LV=180	Low voltage threshold of ST5 set at 18 VDC
LV200	-	Set low voltage threshold of ST5 drive to 20 VDC
LV	LV=900	Low voltage threshold of STAC6 set at 90 VDC (bus voltage)
LV	LV=90	Low voltage threshold of BLuAC5 set at 90 VDC (bus voltage)

---

## MC - Motor Current, Rated

---

Compatibility: Stepper drives (except STM)  
 See also: CC, PN commands

Specifies the maximum current that can be sent to the motor. This is the same value set in ST Configurator's Custom Motor screen for Rated Current.

This value serves as the upper ceiling for the CC command, preventing excessive current from being sent to the motor, potentially damaging it. It is also used when the motor is probed to determine its electrical characteristics (see PN command for details).

### Command Details:

Structure	MC{Parameter #1}
Type	BUFFERED
Usage	READ / WRITE
Non-Volatile	YES
Register Access	None

### Parameter Details:

Parameter #1	Motor Rated Current
- units	amps
- range	0 - 6.00 amps (STAC6 only) 0 - 10.00 amps (ST-S, ST-Q/Si)

### Examples:

Command	Drive sends	Notes
MC2.5	-	Motor maximum current set to 2.5A.
MC	MC=2.5	

---

## MD - Motor Disable

---

Compatibility: All drives

See also: BE, BO, ME commands

Disables motor outputs (reduces motor current to zero). Disabling the motor also activates the Brake Output function (see BO command). Motor current is not reduced to zero until the Brake Engage (BE command) time has expired.

### Command Details:

Structure	MD
Type	BUFFERED
Usage	WRITE ONLY
Non-Volatile	No
Register Access	None

### Examples:

Command	Drive sends	Notes
MD	-	Drive turns off current to the motor

---

## ME - Motor Enable

---

Compatibility: All drives

See also: BD, BO, MD commands

Restores drive current to motor. If the drive cannot be enabled due to the Enable Input (SI) state, the drive will respond with a “&” which indicates that the drive could not be enabled. Enabling the drive also deactivates the Brake Output function (see BO command). Enabling of the motor is delayed by the BD (Brake Disengage) time delay.

**WARNING: This command restores the previous mode of operation. If for example the drive is operating in Analog Velocity mode the motor may immediately start moving. External inputs to the drive must be sequenced properly to avoid unpredictable operation.**

### Command Details:

Structure	ME
Type	BUFFERED
Usage	WRITE ONLY
Non-Volatile	NO
Register Access	None

### Examples:

Command	Drive sends	Notes
ME	-	Drive is enabled
ME	&	Drive is NOT enabled: check Servo Enable input (SI) for proper state

## MN - Model Number

Compatibility: BLu series servo drives, ST, STAC6, some STM, and some legacy step drive models

*NOTE: This command is deprecated. Please use MV to query the drive for model and revision information.*

Requests the drive's Model Number. Drive returns a single character that is a code for the model number.

Unlike most other commands that request data back from the drive, where the drive will send the original Command Code followed by an "=" and then a value, when the MN command is sent to a drive the drive only responds with the single character code. (See below).

### Command Details:

Structure	MN
Type	IMMEDIATE
Usage	READ ONLY
Non-Volatile	NO
Register Access	None
Units	character code (see below)

### Response Details:

Model Number	Character code	Model Number	Character Code
BLuDC4-S*	O	STAC6-220-S	\
BLuDC4-SE*	o	STAC6-220-SE	
BLuDC4-Si*	P	STAC6-220-Q	]
BLuDC4-Q*	W	STAC6-220-QE	}
BLuDC4-QE*	w	STAC6-220-Si	^
BLuDC9-S*	R	ST5-S	D
BLuDC9-SE*	r	ST10-S	E
BLuDC9-Si*	S	ST5-Plus	J
BLuDC9-Q*	X	ST10-Plus	K
BLuDC9-QE*	x	ST5-Q	F
BLuAC5-S	T	ST10-Q	H
BLuAC5-SE	t	ST5-Si	G
BLuAC5-Q	U	ST10-Si	I
BLuAC5-QE	u	STM23S-xxx	a
BLuAC5-Si	V	STM23Q-xxx	b
STAC6-S	Y	SV7-S	;
STAC6-SE	y	SV7-Q	<
STAC6-Q	Z	SV7-Si	=
STAC6-QE	z		
STAC6-Si	[		

\* BLu100 and BLu200 series drives have been replaced by BLuDC4 and BLuDC9 series drives, respectively. BLu100 and BLu200 drives are still supported, but part numbers have been changed.

### Examples:

Command	Drive sends	Notes
MN	T	Connected drive is a BLuAC5-S

---

## MO - Motion Output

---

Compatibility: All drives

See also: AO, BO, PL, SD and TO commands

Defines the drive's Motion Output digital output function.

For all stepper drives there are 8 states available:

MO1: Output is closed (energized) when motor is not moving.

MO2: Output is open (de-energized) when motor is not moving.

MO3: Output is not used as a Motion Output and can be used for another automatic output function or as a general purpose output.

MO4: Output is used as a Tach Output at 100 pulses/rev with 1.8 degree step motor.

MO5: Output is used as a Tach Output at 200 pulses/rev with 1.8 degree step motor.

MO6: Output is used as a Tach Output at 400 pulses/rev with 1.8 degree step motor.

MO7: Output is used as a Tach Output at 800 pulses/rev with 1.8 degree step motor.

MO8: Output is used as a Tach Output at 1600 pulses/rev with 1.8 degree step motor.

For SV200 servo drives, this command is designed to control 4 outputs (Y3,Y4,Y5,Y6) using 2 parameters (MO{Param#1}{Param#2}). For details, refer to the SV200 Hardware Manual and SVX Servo Suite software.

For SV servo drives (SV7 and SVAC3) there are 10 states available:

MO1: Output is closed (energized) when motor is not moving.

MO2: Output is open (de-energized) when motor is not moving.

MO3: Output is not used as a Motion Output and can be used for another automatic output function or as a general purpose output.

MO4: Output is used as a Tach Output at 64 pulses/rev with 8 pole motor (8 times number of poles)

MO5: Output is used as a Tach Output at 128 pulses/rev with 8 pole motor (16 times number of poles)

MO6: Output is used as a Tach Output at 256 pulses/rev with 8 pole motor (32 times number of poles)

MO7: Output is used as a Tach Output at 512 pulses/rev with 8 pole motor (64 times number of poles)

MO8: Output is used as a Tach Output at 1024 pulses/rev with 8 pole motor (128 times number of poles)

MO9: Output is closed when in position based on encoder error

MO10: Output is open when in position based on encoder error

For SSM and TXM-S/Q/IP there are 11 states available:

MO1: Output is open (de-energized) when static position error is less than set value.

MO2: Output is closed (energized) when static position error is less than set value.

MO3: Output is not used as a Motion Output and can be used for another automatic output function or as a general purpose output.

MO4: Output is used as a Tach Output at 100 pulses/rev.

MO5: Output is used as a Tach Output at 200 pulses/rev.

MO6: Output is used as a Tach Output at 400 pulses/rev.

MO7: Output is used as a Tach Output at 800 pulses/rev.

MO8: Output is used as a Tach Output at 1600 pulses/rev.

MO9: Output is closed (energized) when dynamic position error is less than set value.

MO10: Output is open (de-energized) when dynamic position error is less than set value.

MO11: Output is used as a Tach Output at 50 pulses/rev.

For TSM there are 3 states available to control the Y2 output:

MO3: Output is not used as a Motion Output and can be used for another automatic output function or as a general purpose output.



MO9: Output is closed (energized) when dynamic position error is less than set value.  
 MO10: Output is open (de-energized) when dynamic position error is less than set value.

**NOTE:** for other Motion Output settings such as static in-position and tach output for TSM products, please refer to TO command

#### BLu, SV, STAC6, ST-Q/Si, STAC5-S, SVAC3-S

Output Y2 is the designated Motion Output.

#### STAC5-Q/IP and SVAC3-Q/IP

Output OUT1 is the designated Motion Output.

#### ST-S, STM17-S/Q/C, STM23-Q/C, STM24-C

The one output of these drives (OUT) can be assigned to one of the five available functions: alarm output, brake output, motion output, tach output, or general purpose output. Each of these functions must exclusively use the output, so only one function is allowed. There are two ways to define the function of this output: via the *ST Configurator* software or via the MO command.

#### STM24-SF/QF

Drives with Flex I/O allow a second parameter which allows the user to specify the I/O point used. Before an I/O point can be used as a Motion Output it must first be configured as an output with the SD command.

Possible uses for the MO command on the STM24 are as follows ('n' denotes the I/O point to be used):

- MO1n: Output is closed (active, low) when a Drive Fault is present.
- MO2n: Output is open (inactive, high) when a Drive Fault is present.
- MO3n: Output is not used as an Alarm Output and can be used for another automatic output function or as a general purpose output.
- MO4n: Output is used as a Tach Output at 100 pulses/rev with 1.8 degree step motor.
- MO5n: Output is used as a Tach Output at 200 pulses/rev with 1.8 degree step motor.
- MO6n: Output is used as a Tach Output at 400 pulses/rev with 1.8 degree step motor.
- MO7n: Output is used as a Tach Output at 800 pulses/rev with 1.8 degree step motor.
- MO8n: Output is used as a Tach Output at 1600 pulses/rev with 1.8 degree step motor.

**NOTE:** Setting the MO command to 1, 2, or 4 - 8 overrides previous assignments of this output's function. Similarly, if you use the AO or BO command to set the function of the output after setting the MO command to 1 or 2, usage of the output will be reassigned and AO will be automatically set to 3.

### Command Details:

Structure	MO{Parameter #1}{Parameter #2 (Flex I/O only)}
Type	BUFFERED
Usage	READ/WRITE
Non-Volatile	YES
Register Access	None

## Parameter Details:

Parameter #1	Output Usage (see above)
- units	integer code
- range	1, 2 or 3
Parameter #2 (Flex I/O only)	I/O Point (if applicable, see note below)
- units	integer code
- range	1 - 4

**NOTES:**

- The SD command must be executed to set an I/O point as an output before that output can be designated as the Motion Output.
- Parameter #2 only applies to drives equipped with Flex I/O. This includes the STM24-S and -Q. Parameter #2 is not defined for drives equipped with standard I/O.

## Examples:

## All drives with standard I/O:

Command	Drive sends	Notes
MO1	-	Motion Output will close when the motor is not moving
MO	MO=1	

## Drives with Flex I/O only:

Command	Drive sends	Notes
SD4O	-	Configures I/O 4 as output (see SD command for details)
MO14	-	Motion Output is mapped to output #4, and will close when the motor is not moving
MO	MO=14	

## STM24-S, -Q only

Command	Drive sends	Notes
MO14	-	I/O point 4 will be closed when motor is not moving
MO	MO=14	

**NOTE:** When working with digital inputs and outputs it is important to remember the designations low and high. If current is flowing into or out of an input or output, i.e. the circuit is energized, the logic state for that input/output is defined as low or closed. If no current is flowing, i.e. the circuit is de-energized, or the input/output is not connected, the logic state is high or open. A low state is represented by the "L" character in parameters of commands that affect inputs/outputs. For example, WI3L means "wait for input 3 low", and SO1L means "set output 1 low". A high state is represented by the "H" character.

## MR - Microstep Resolution

Compatibility: All Stepper Drives  
 Affects: Microstep Resolution  
 See also: EG command

The MR command allows the user to set or request the Microstep Resolution of the drive.

*NOTE: The MR command has been deprecated, and should no longer be used. It is included here solely for compatibility with older programs. New applications should make use of the EG command.*

### Command Details:

Structure	MR{Parameter #1}
Type	BUFFERED
Usage	READ/WRITE
Non-Volatile	YES
Register Access	None

### Parameter Details:

Parameter #1	Microstep Resolution (code)
- units	Integer
- range	0 - 15:  Code, steps/rev 0 = 200 1 = 400 3 = 2000 4 = 5000 5 = 10,000 6 = 12,800 7 = 18,000 8 = 20,000 9 = 21,600 10 = 25,000 11 = 25,400 12 = 25,600 13 = 36,000 14 = 50,000 15 = 50,800

### Examples:

Command	Drive sends	Notes
MR8	-	Set the drive's microstep resolution to 20,000 steps/rev
MR	MR=8	

## MS - Control Mode Selection

Compatibility: SV200 series servo drives only  
 Affects: Control mode, Input #8  
 See also: CM, CN commands

Defines the usage of input X8 for control mode selection.

MS1: CM is selected when input X8 is open, and CN is selected when input X8 is closed.

MS2: CM is selected when input X8 is closed, and CN is selected when input X8 is open.

MS3: Input X8 is used as general purpose input. Drive control mode is main mode (CM).

### Command Details:

Structure	MS{Parameter #1}
Type	BUFFERED
Usage	READ/WRITE
Non-Volatile	YES
Register Access	None

### Parameter Details:

Parameter #1	Control Mode Selection(see above)
- units	integer code
- range	1~3
Default value:	3

### Examples:

Command	Drive sends	Notes
MS1	%	set the usage of control mode selection to 1
MS	MS=1	the usage of control mode selection is 1

## MT - Multi-Tasking

Compatibility: Q drives only  
 Affects: All move commands  
 See also: CJ, OI, QJ, TI, TR, and WM commands

Sets or request the status of the multi-tasking function (on or off). When multi-tasking is enabled (on), commands such as FL (Feed to Length) or HW (Hand Wheel) do not block execution of subsequent commands in the queue or program segment. This allows executing other type of operations, such as setting outputs (SO), while a move is taking place.

### Command Details:

Structure	MT{Parameter #1}
Type	BUFFERED
Usage	READ/WRITE
Non-Volatile	No
Register Access	None

### Parameter Details:

Parameter #1	Multi-tasking switch
- units	integer
- range	0 = multi-tasking disabled 1 = multi-tasking enabled

### Examples:

Command	Drive sends	Notes
MT1	-	Enables multi-tasking
MT	MT=1	

---

## MV - Model & Revision

---

Compatibility: All drives and integrated motors except BLu servo drives  
See also: MN, RV commands

Requests the connected drive's DSP firmware version, model number code, and sub-model number code (if applicable). Not all drive series utilize the sub-model number code. The response from the drive is a single string of characters with no breaks or delimiters. The sequence of characters is firmware revision (3 numbers and 1 letter), model number code (3 numbers), sub-model number code (1 letter). See Response Details below.

### Command Details:

Structure	MV
Type	IMMEDIATE
Usage	READ ONLY
Non-Volatile	No
Register Access	None

## Response Details:

Response will be in the format AAAABBBBC, where AAAA is the firmware version, BBB is the model number code, and C is the sub-model number code. Model and sub-model number codes are listed below by drive, and Examples are given afterward.

Drive	Model Number
SV7-S	11
SV7-Q	12
SV7-Si	13
SV7-CANopen	14
SV7-IP	15
SV7-Q Ethernet	16
ST5-Q Ethernet	17
ST10-Q Ethernet	19
ST5-S	20
ST10-S	21
ST5-Q	22
ST5-Si	23
ST10-Q	24
ST10-Si	25
ST5plus	26
ST10plus	27
ST5 can open	28
ST10 can open	29
BLuAC5-S	36
BLuAC5-Q	37
BLuAC5-Si	38
STAC6-S	41
STAC6-Q	42
STAC6-Si	43
STAC6-S-220	44
STAC6-Q-220	45
STAC6-Si-220	46
STAC6-C	47
STAC6-C-220	48
STM23-S family	49
STM23-Q family	50
STM24-SF family	51
STM24-QF family	52
STM24-C family	53
STM23-C family	54
STM17-S family	55
STM17-Q family	56
STM17-C family	57
BLuAC5-SE	68

<b>BLuAC5-QE</b>	<b>69</b>
<b>STM23IP</b>	<b>70</b>
<b>STAC6-SE</b>	<b>73</b>
<b>STAC6-QE</b>	<b>74</b>
<b>ST5-IP</b>	<b>75</b>
<b>STAC6-SE-220</b>	<b>76</b>
<b>STAC6-QE-220</b>	<b>77</b>
<b>ST10-IP</b>	<b>78</b>
<b>STAC5-S</b>	<b>79</b>
<b>STAC5-Q</b>	<b>80</b>
<b>STAC5-IP</b>	<b>83</b>
<b>STAC5-S-220</b>	<b>85</b>
<b>STAC5-Q-220</b>	<b>86</b>
<b>STAC5-IP-220</b>	<b>89</b>
<b>STM24IP-xxx</b>	<b>90</b>
<b>SVAC3-S</b>	<b>91</b>
<b>SVAC3-Q</b>	<b>92</b>
<b>SVAC3-IP</b>	<b>95</b>
<b>SVAC3-S-220</b>	<b>97</b>
<b>SVAC3-Q-220</b>	<b>98</b>
<b>SVAC3-IP-220</b>	<b>101</b>
<b>TSM23</b>	<b>103-105</b>
<b>TSM17</b>	<b>111-112</b>
<b>SWM24IP-xxx</b>	<b>128</b>
<b>SWM24S-xxx</b>	<b>144</b>
<b>SWM24Q-xxx</b>	<b>145</b>
<b>SWM24C-xxx</b>	<b>146</b>
<b>TXM24S-xxx</b>	<b>147</b>
<b>TXM24Q-xxx</b>	<b>148</b>
<b>TXM24C-xxx</b>	<b>149</b>
<b>SSM23-IP</b>	<b>162</b>
<b>TXM24-IP</b>	<b>165</b>
<b>TSM11</b>	<b>171</b>
<b>SV200</b>	<b>180</b>

**Examples:**

Command	Drive sends	Notes
MV	100Q012	Drive connected has DSP firmware version 1.00Q, and the drive model number is SV7-Q
MV	103F042	Drive connected has DSP firmware version 1.03F, and the drive model number is STAC6-Q
MV	102J049A	Drive connected has DSP firmware version 1.03F, and the drive model number is STM23S-2AN



---

## NO - No Operation

---

Compatibility: Q drives only  
 Affects: Stored program flow

Q programs halt execution at blank lines. If a “no op” line is required in a program, for comments or other purposes, rather than leave the line blank the NO command is used. Think of the NO command as leaving a blank line in the middle of a sequence of commands. This is useful if after creating a sequence of commands you would like to delete a command without the line numbers of the remaining commands changing. Instead of deleting the line with the unwanted command, replace the unwanted command with a NO command and the remaining commands in the sequence will maintain their respective line numbers.

*NOTE: NO commands are not required after the last command in a segment.*

### Command Details:

Structure	NO
Type	BUFFERED
Usage	WRITE ONLY
Non-Volatile	NO
Register Access	None

### Examples:

Command	Drive sends	Notes
NO	-	No operation takes place at this program line

## OF - On Fault

Compatibility: Q drives only  
 Affects: Stored program flow  
 See also: AL, AX, AX, ME, OI commands

When a drive fault occurs, the OF command causes a given program segment to immediately load from non-volatile memory into the queue. The OF command acts as a kind of software switch in that when this function is turned on the drive's response to a drive fault (loading the designated program segment) is automatic. Once a fault occurs the fault must be cleared (AX) and the motor re-enabled (ME) before continuing normal program execution.

Please note that while immediately executing AX will clear the alarm code, it does not guarantee that the condition that caused the alarm has been resolved. Therefore it is recommended to include a short delay or wait for user input before clearing the alarm and resuming normal operation.

Also, a drive fault will turn the OF function off, so after a fault the OF command must be executed again to reset the function. For this reason it is common to place the OF command in segment 1 of a Q program, and then load segment 1 (QX1) from the designated OF segment after the fault has been cleared and the motor re-enabled. A parameter value of "0" disables the On Fault function. See the AL (Alarm code) command for details of drive faults.

### Command Details:

Structure	OF(Parameter #1)
Type	BUFFERED
Usage	WRITE ONLY
Non-Volatile	No
Register Access	None

### Parameter Details:

Parameter #1	program segment #
- units	integer
- range	1 - 12 = segment 1 - 12 0 = disable On Fault function

### Examples:

Command	Drive sends	Notes
<i>In segment 1 of a Q program...</i>		
OF9	-	When a drive fault occurs load and execute program segment 9
<i>In segment 9 of the same Q program...</i>		
WT0.1	-	Short delay to allow the system to settle
AX	-	Alarm reset
ME	-	Motor enable
QX1	-	Load and execute segment 1, which will also reset the OF function.
OF0	-	Disable the On Fault function

## OI - On Input

Compatibility: Q drives only  
 Affects: Interrupt function and stored program flow  
 See also: MT, OF command

When the given input condition is met the OI command causes program segment 10 to immediately load from non-volatile memory into the queue. The OI command operates as a kind of software switch. Executing the command turns the interrupt function on. Responding to the interrupt input (by loading segment 10) turns the interrupt function off. Therefore after an interrupt condition is cleared in the system the OI command must be executed again to reset the interrupt function. One way to do this is place a copy of the OI command near the end of segment 10, before loading and executing another segment (QX command). Only one interrupt input can be defined at a time within a program. Executing the OI command with no parameter disables the interrupt function.

If Multi-Tasking is disabled (MT0, default) when the input condition is met, any move in progress will be aborted and Segment 10 will be loaded immediately. If Multi-Tasking is enabled (MT1) when the input condition is met, the program will branch to Segment 10 without interrupting a move in progress. In this scenario a Stop Move (SM) command may be used to abort the move.

### Command Details:

Structure	OI{Parameter #1}
Type	BUFFERED
Usage	WRITE ONLY
Non-Volatile	No
Register Access	None

### Parameter Details:

(See Appendix F: Working With Inputs and Outputs)

#### Examples:

Command	Drive sends	Notes
MT0	-	Turn Multi-Tasking off
OIX5F	-	Load and execute program segment 10 when input X5 goes from high to low. If a move is in progress, abort it.
MT1	-	Turn Multi-Tasking on
OIX5F	-	Load and execute program segment 10 when input X5 goes from high to low. Has no effect on a move already in progress.
OI	-	Disable interrupt function

## OP - Option board

Compatibility: All drives  
 See also: IF, MV commands

Requests the decimal or hexadecimal equivalent (see IF command) of the option board's 7-bit binary word. Since some drives - like the SV, ST-Q/Si, and STM drives - are available with different option boards, it is useful for the host to be able to request this information from the drive. The 7 bits in the option board's binary word are shown below.

Bit	Value (Hex)	SV7	SVAC3	ST	STAC5
0	1	Encoder Board	Encoder Board	Encoder Board	Encoder Board
1	2	RS-485	reserved	RS-485	reserved
2	4	CANOpen	reserved	CANOpen	reserved
3	8	reserved	reserved	reserved	reserved
4	10	reserved	reserved	reserved	reserved
5	20	MCF Board *	reserved	MCF Board *	Expanded I/O
6	40	Ethernet	Ethernet	Ethernet	0
7	80	reserved	Expanded I/O	reserved	reserved

\* This board includes encoder output so drives with this option will also have bit 0 set

### Command Details:

Structure	OP
Type	IMMEDIATE
Usage	READ ONLY
Non-Volatile	Yes
Register Access	None

### Examples:

IF command set for decimal (IFD)...

Command	Drive sends	Notes
OP	OP3	Drive has both encoder and RS-485 option boards installed
OP	OP4	Drive has CANOpen board installed
OP	OP33	Drive has MCF board installed (bits 0 and 5 are set)

IF command set for hexadecimal (IFH)...

Command	Drive sends	Notes
OP	OP0003	Drive has both encoder and RS-485 option boards installed
OP	OP0004	Drive has CANOpen board installed
OP	OP0021	Drive has MCF board installed

## PA - Power-up Acceleration Current

Compatibility: STM Integrated Step Motors  
 Affects: Motor accel/decel current and torque  
 See also: PC, CC, CA, SA commands

Sets or requests the power-up accel/decel current setting (“peak of sine”) of the stepper drive, also known as the peak current. PA is similar to the CA command in that a change to PA affects the current value of the accel/decel current. However PA differs from CA in that a change to PA is automatically written to non-volatile memory at the time of the change. For a change in CA to be written to non-volatile memory an SA command must be executed afterwards. See below for more details. PA will only accept parameter values equal or larger than the current PC setting.

Relationship of PA, CA, and “M” register:

- A change to PA affects the current accel/decel current value and is automatically stored in non-volatile memory.
- A change to PA automatically changes CA and the “M” register to the same value.
- A change to CA or the “M” register only affects the current accel/decel current value, but does not automatically change PA to the same value.
- A change to CA or the “M” register is stored in non-volatile memory only after an SA command is executed. When this occurs the PA command is also automatically changed to the new value.

*NOTE: PA has no effect in Command Mode 7 (CM7 - Step and Direction mode).*

### Command Details:

Structure	PA{Parameter #1}
Type	BUFFERED
Usage	READ/WRITE
Non-Volatile	Yes (see note below)
Register Access	“M” (029)

*Note: The PA and CA commands use different units than the “M” register; see Data Registers section for details*

### Parameter Details:

Parameter #1	Power-up accel/decel current
- units	Amps (resolution is 0.01 amps)
- range	STM24: 0-6.0 STM23: 0-5.0 STM17: 0-2.0

Configurator software may also be used to set all current levels.

*NOTE: This data is saved to non-volatile memory immediately upon execution. It is not required to execute the SA command to save to non-volatile memory.*

Example:

STM17, STM23, STM24

Command	Drive sends
PA1.2	-
PA	PA=1.2

Notes

Set power-up accel/decel current to 1.2 amps (peak of sine)

## PB - Power-up Baud Rate

Compatibility: All drives  
 See also: BR, PR, TD commands

Sets or requests the power-up baud rate for serial communications. When executed, this command sets the baud rate and immediately saves it to non-volatile memory. At power-up the drive defaults to 9600 baud. If an Applied Motion software application is not detected after 1 second and the drive is configured for host operation the drive will set the baud rate according to the value stored in the Power-up Baud Rate non-volatile parameter. A host system can change the baud rate at any time.

*NOTE: Setting the baud rate takes effect immediately.*

### Command Details:

Structure	PB{Parameter #1}
Type	BUFFERED
Usage	READ/WRITE
Non-Volatile	Yes (see note below)
Register Access	None

### Parameter Details:

Parameter #1	Baud rate code
- units	integer code
- range	1 = 9600 2 = 19200 3 = 38400 4 = 57600 5 = 115200

*NOTE: This data is saved to non-volatile memory immediately upon execution. It is not required to execute the SA command to save to non-volatile memory.*

### Examples:

Command	Drive sends	Notes
PB2	-	Power-up baud rate is set to 19200 and this value is immediately saved to non-volatile memory
PB	PB=2	

## PC - Power-up Current

Compatibility: All drives  
 Affects: Motor current and torque  
 See also: CC, PI, PP commands

If using a stepper drive, PC sets or requests the continuous (RMS) current setting of the servo drive. If using a servo drive, PC sets or requests the current setting (“peak of sine”) of the stepper drive, also known as the running current.

*NOTE: This command is similar to CC. It differs only in that in addition to setting the continuous current of the drive, PC also immediately saves the setting to NV memory. See CC command for further details.*

### Command Details:

Structure	PC{Parameter #1}
Type	BUFFERED
Usage	READ/WRITE
Non-Volatile	Yes (see note below)
Register Access	“N” (030) Note: The PC and CC commands use different units than the “N” register; see Data Registers section for details

### Parameter Details:

#### BLu, SV, SVAC3

Parameter #1	Power-up continuous current setting
- units	amps rms (resolution is 0.01 amps)
- range	BLuDC4: 0 - 4.5 BLuDC9: 0 - 9.0 BLuAC5: 0 - 5.0 SV: 0 - 7.0 SVAC3 (120V): 0 - 3.5 SVAC3 (220V): 0 - 1.8

#### STAC6, ST-Q/Si, ST-S, STM, STAC5

Parameter #1	Running current
- units	amps (resolution is 0.01 amps)
- range	STAC6: 0 - 6.0 ST5 : 0 - 5.0 ST10: 0 - 10.0 STM17: 0 - 2.0 STM23: 0 - 5.0 STM24: 0 - 6.0 STAC5 (120V): 0 - 5 STAC5 (220V): 0 - 2.55

*NOTE: Applied Motion recommends using Configurator software to select a motor and set the maximum current.*

### Examples:

Command	Drive sends	Notes
PC3.2	-	Set power-up continuous current to 3.2 amps RMS for servo drive or 3.2 amps running current for stepper drive
PC	PC=3.2	



## PD - In-Position Counts

Compatibility: SSM, TSM, TXM, SS, SSAC and SV200 series servo  
 See also: MO, TO, PE commands

This parameter is used to set static in-position error range. When the actual position is within the target In-position error range for a time duration that exceeds the PE specified timing, then the driver will define the motion complete or motor in-position.

### Command Details:

Structure	PD{Parameter #1}
Type	BUFFERED
Usage	READ/WRITE
Non-Volatile	YES
Register Access	None

### Parameter Details:

Parameter #1	In-position limit
- units	encoder counts
- range	0~32767
-default	

### Examples:

Command	Drive sends	Notes
PD100	-	Sets the static in-position limit to 100 encoder counts
PD	PD=100	

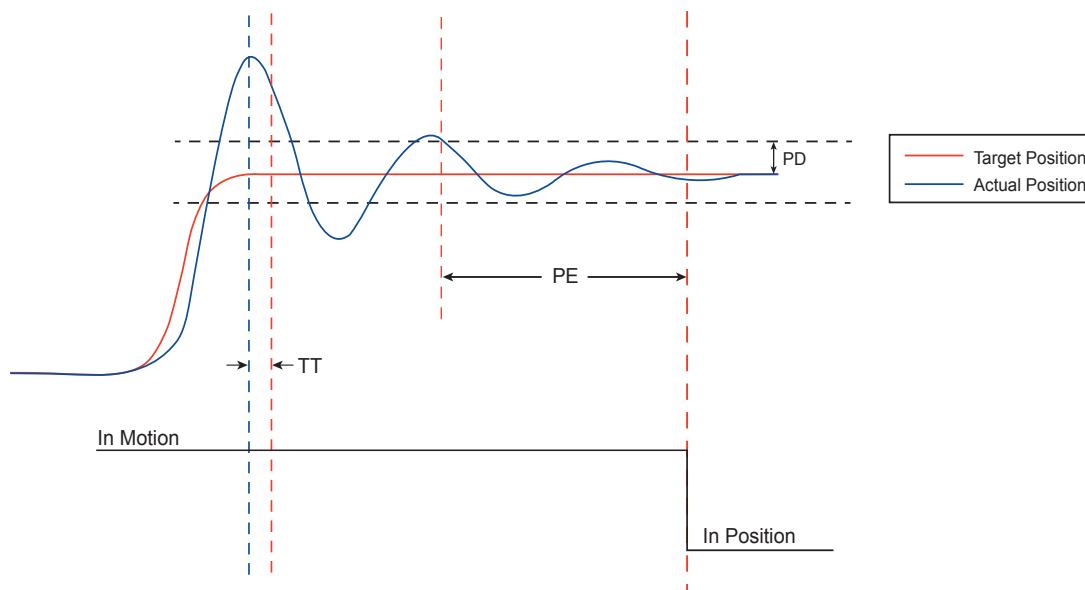

## PE - In-Position Timing

Compatibility: SSM, TSM, TXM, SS, SSAC and SV200 series servo drives  
 See also: MO, TO, PD commands

Sets or requests the time duration for in range determination. For example, when In position error PD is defined, PE will set the time duration for in-position test condition. The drive defines the motor as in position when the actual position is within the target position range (PD) for the defined minimum time (PE).

Time is counted as processor cycles, one cycle refers to 200µsec (250µsec for SV200).

### Command Details:

Structure	PE{Parameter #1}
Type	BUFFERED
Usage	READ/WRITE
Non-Volatile	YES
Register Access	None

### Parameter Details:

Parameter #1	In-position Timing
- units	200µsec, (250µsec for SV200)
- range	0~30000
-default	10

### Examples:

Command PE100      Drive sends -      Notes Sets the static in-position timing to 20ms for in range determination on a StepSERVO.

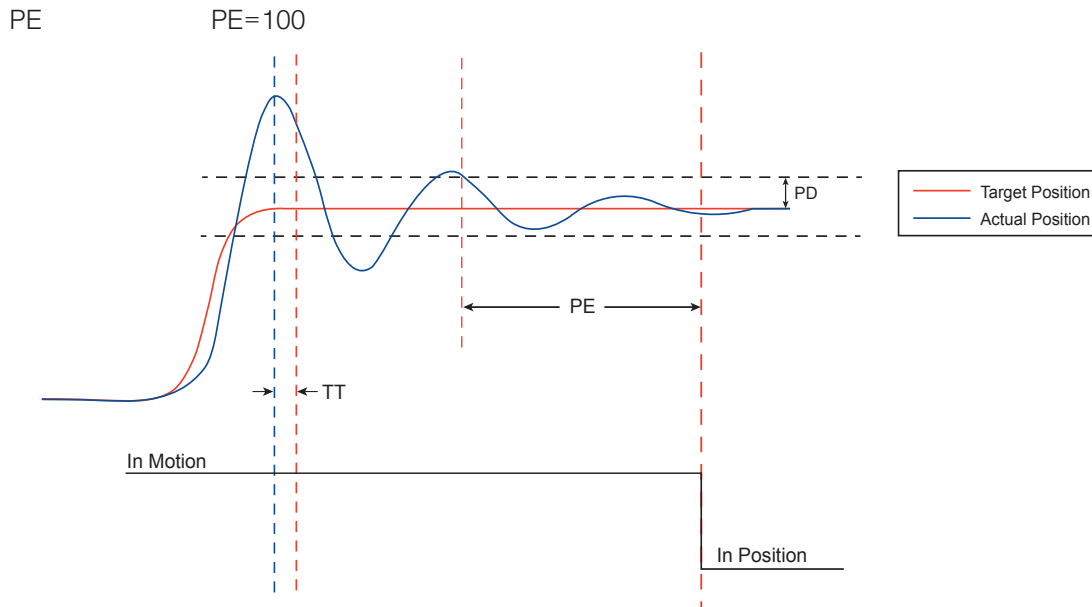

## PF - Position Fault

Compatibility: Servo drives and stepper drives with encoder feedback

### Servo drives

Sets or requests the Position Fault limit in encoder counts. This value defines the limit threshold, in encoder counts, reached between actual position and commanded position before the system produces a position fault error.

### Stepper drives:

Sets or requests the “percentage of torque” used in the Stall Prevention function for systems with an encoder installed on the motor. Making this setting with the PF command requires that an SA (Save) command be sent afterwards, then a power-down/power-up cycle before the change will take effect. It is recommended that the *Configurator* software be used to make this setting.

### Command Details:

Structure	PF{Parameter #1}
Type	BUFFERED
Usage	READ/WRITE
Non-Volatile	Yes
Register Access	None

### Parameter Details:

Parameter #1	Servo: Position fault limit Stepper: Percentage of torque
- units	Servo: encoder counts Stepper: percentage of torque
- range	Servo: 1 - 32767 Stepper: 0 - 100 (percent)

### Examples:

Command	Drive sends	Notes
PF2000	-	Set position fault limit to 2000 counts in servo drive
PF	PF=2000	
PF50	-	Set percentage of torque to 50% in stepper drive fitted with encoder and with the Stall Prevention function turned on
PF	PF=50	

## PH - Inhibit Pulse Command

Compatibility: SV200 series servo drives only  
 Affects: Control mode 7, Input #10

Defines the usage of input X10 as inhibiting the pulse input as position command.  
 PH1: Inhibit the pulse input as position command when input X10 is closed.  
 PH2: Inhibit the pulse input as position command when input X10 is open.  
 PH3: Input X10 is used as general purpose input.

### Command Details:

Structure	PH{Parameter #1}
Type	BUFFERED
Usage	READ/WRITE
Non-Volatile	YES
Register Access	None

### Parameter Details:

Parameter #1	inhibit pulse command
- units	Integer
- range	1~3
-default value	3

### Examples:

Command	Drive sends	Notes
PH1	%	Sets the usage of the pulse command inhibit function to 1
PH	PH=1	The usage of the pulse command inhibit function is 1

## PI - Power-up Idle Current

Compatibility: Stepper drives only  
 Affects: Motor current at standstill, holding torque  
 See also: CC, CD, CI commands

Idle current is the level of current supplied to each motor phase when the motor is not moving. Using an idle current level lower than the running motor current (see CC and PC commands) aids in motor cooling. A common level used for the idle current setting is 50% of the running current. After a motor move, there is a time delay after the motor takes its last step before the reduction to the idle current takes place. This delay is set by the CD command.

This command is similar to the CI command. It differs only in that in addition to setting the idle current of the drive, PI also immediately saves the setting to NV memory. See CI command page for details.

### Command Details:

Structure	PI{Parameter #1}
Type	BUFFERED
Usage	READ/WRITE
Non-Volatile	Yes (see note below)
Register Access	“O” (031) Note: The CI command uses different units than the “O” register; see Data Registers section for more details

### Parameter Details:

#### STAC6

Parameter #1	Idle current at power-up
- units	amps
- range	0 - 100% of running current

#### ST-Q/Si, ST-S, STM, STAC5

Parameter #1	Idle current at power-up
- units	amps
- range	0 - 90% of running current

*NOTE: This data is saved to non-volatile memory immediately upon execution. It is not required to execute the SA command to save to non-volatile memory.*

### Examples:

Command	Drive sends	Notes
PI0.75	-	Set power-up idle current to 0.75 amps
PI	PI=0.75	

---

## PK - Parameter Lock

---

Compatibility: SV200 series servo drive only  
 Affects: Front panel operation

This parameter determines whether or not the front panel push buttons can be used to modify drive parameters. Locking out the front panel can be done to prevent drive parameters from being changed without a connection to a PC running *SVX Servo Suite*.

0 = can be modified on front panel  
 1 = can not be modified on front panel

### Command Details:

Structure	PK{Parameter #1}
Type	BUFFERED
Usage	READ/WRITE
Non-Volatile	YES
Register Access	None

### Parameter Details:

Parameter #1	See above
- units	Integer
- range	0~1
-default	0

### Examples:

Command	Drive sends	Notes
PK0	%	Allow the parameters to be modified at drive's front panel
PK	PK=0	the parameters can be modified through the front panel

## PL - Position Limit

Compatibility: Servo drives only  
 Affects: Motion Output function  
 See also: MO command

Sets or requests the count value used by the servo to determine if the motor is in position. This is used by the servo for determining the state of Motion Output (see MO command). When performing a move the Motion Output will be set to the designated condition until the servo is in position at the end of a move. The "In Position" status is set in the same way.

### Command Details:

Structure	PL{Parameter #1}
Type	BUFFERED
Usage	READ/WRITE
Non-Volatile	Yes
Register Access	None

### Parameter Details:

Parameter #1	Positioning limit
- units	encoder counts
- range	0 - 32767

### Examples:

Command	Drive sends	Notes
PL20	-	Set position limit to 20 counts
PL	PL=20	

## PM - Power-up Mode

Compatibility: All drives  
 See also: CM command

Sets or requests the power-up mode of the drive. PM determines how the drive is configured for serial communications at power-up. For example, for SCL applications set PM=2 or PM=5. The power-up mode is also set when configuring the drive with *Quick Tuner* or *Configurator*. PM2 (Q / SCL) is the same as PM7 (Q Program Mode), except the program is not automatically executed at power up.

### Q drives

When creating Q Programs for your Q drive, checking the “Execute “Q” at Power-up” box on the main screen of the Q Programmer software will change the power-up mode of the drive to 7 (PM7) with the next download. This will cause the drive to run its stored Q Program at power-up. You must download the program after checking this box for the change to take effect.

### Si drives

An Si drive is set to PM1 automatically when an Si program is downloaded to the drive. If the drive is currently set to PM7 for operation in Q mode, simply uploading and executing a stored Si program will not change the power-up mode of the drive to PM1. The program may be uploaded and executed, but the drive will not power up and execute the Si program until after a download through the *Si Programmer* software.

*NOTE: If the drive is configured for power-up modes 1 or 3, it will not respond to SCL commands issued by a host device. If SCL communications are required in this scenario, the host device must recognize the drive’s power-up packet and issue the response “00” (double-zero, no carriage return) within two seconds to force the drive into SCL mode without altering the PM setting. See Appendix B for further information.*

### Command Details:

Structure	PM {Parameter #1}
Type	BUFFERED
Usage	READ/WRITE
Non-Volatile	Yes (see note below)
Register Access	None

### Parameter Details:

Parameter #1	Power on mode
- units	integer code
- range	1 = Si Program (Si versions only) 2 = Q / SCL (drive enabled) 3 = Quick Tuner (servos) or Configurator (steppers) 4 = SiNet Hub 5 = Q / SCL (drive disabled) 6 = not used 7 = Q Program, Auto-execute (Q drives only) 8 = Modbus (drive enabled) 9 = Modbus, auto-execute Q program 10 = Modbus (drive disabled)

*NOTE: This data is saved to non-volatile memory immediately upon execution. It is not required to execute the SA command to save to non-volatile memory.*

### Examples:

Command	Drive sends	Notes
PM2	-	Drive will power up in Q / SCL mode (drive enabled)
PM	PM=2	



---

## PN - Probe On Demand

---

Compatibility: Stepper drives  
 See also: EF, MC commands

Perform a full-current probe of the motor. The motor's maximum rated current is used as defined by the MC command. This allows the drive to dynamically measure electrical parameters such as inductance and resistance, which are used to optimize the drive's control over the motor.

This probe is automatically done on power-up and after an EF command is issued, but may be performed at any time using the PN command.

*NOTE: This operation will briefly energize the motor with full current. Use caution when executing the PN command as this may cause slight movement of the motor shaft.*

### Command Details:

Structure	PN
Type	BUFFERED
Usage	WRITE ONLY
Non-Volatile	NO
Register Access	None

### Examples:

Command	Drive sends	Notes
PN	-	Perform a full-current probe of the motor.

---

## PP - Power-up Peak current

---

Compatibility: Servo drives only  
 Affects: Motor current, especially during acceleration and deceleration  
 See also: CC, CP, PC commands

Sets or requests the power-up peak (RMS) current setting of the servo drive. This command differs from the CP command in that in addition to setting the peak current of the drive, PP also immediately saves the setting to NV memory. In other words, PP = CP + SA.

### Command Details:

Structure	PP{Parameter #1}
Type	BUFFERED
Usage	READ/WRITE
Non-Volatile	YES
Register Access	None

### Parameter Details:

Parameter #1	Power-up peak current limit
- units	amps RMS (resolution is 0.01 amps)
- range	BLuDC4: 0 - 13.5 BLuDC9: 0 - 18.0 BLuAC5: 0 - 15.0 SV7: 0 - 7.0 SVAC3 (120V): 0 - 7.5 SVAC3 (220V): 0 - 3.75

### Examples:

Command	Drive sends	Notes
PP6	-	Set power-up peak current to 6.0 amps RMS
PP	PP=6	

## PR - Protocol

Compatibility: All drives  
 Affects: RS-232 & RS-485 Serial Communications  
 See also: BR and PB commands

Sets or requests the serial communication protocol settings. Sets or requests the serial communication protocol settings. There are a number of settings that can be turned on or off in the PR command. Each setting is assigned a bit in a 9 - bit binary word. The parameter of the PR command is the decimal equivalent of this word. If you send the PR command without a parameter the drive will respond with the decimal equivalent of the word as well. The different protocol settings and their bit assignments are shown below.

### Command Details:

Structure	PR{Parameter #1}
Type	BUFFERED
Usage	READ/WRITE
Non-Volatile	Yes
Register Access	None

### Parameter Details:

Parameter #1	Protocol code
- units	decimal (integer) value of binary word
- range	1 - 511 (000000001 - 111111111)  bit 0 = Default ("Standard SCL") bit 1 = Always use Address Character bit 2 = Ack/Nack bit 3 = Checksum bit 4 = (reserved) bit 5 = 3-digit numeric register addressing bit 6 = Checksum Type (step-servo and SV200 only) bit 7 = Little/Big Endian in Modbus Mode bit 8 = Full Duplex in RS-422

\*Bit 0 is only required when all other bits are set to 0. If any other bit in the word is set to 1, Bit 0 is ignored. For example, PR4 and PR5 provide the same protocol settings.

Bit3 = 1: has checksum / 0: No checksum

Bit6 = 1: STM type checksum / 0: SSM type checksum

\*For more details about STM type checksum and SSM type checksum, please refer to Appendix D.

Bit7 = 1: Little Endian / 0: Big Endian

Bit8 = 1: Full Duplex / 0: Half Duplex

### Examples:

Command	Drive sends	Notes
PR1	-	Set to standard SCL protocol
PR4	-	Turn Ack/Nack on
PR	PR=4	

---

## PS - Pause

---

Compatibility: All drives  
 See also: BS, CT command

Suspends execution of buffered commands until the next CT (Continue) command is executed. This can be useful for coordinating motion among axes by first pausing (PS) the drives, then loading the drives' command buffers with commands, and then resuming command execution (CT) in all drives at once. PS can also be useful for holding a sequence of commands in the drive's command buffer to time with an external event. Use the PS command to pause the command buffer, then send each (buffered type) command in the desired sequence to the drive. When the timing with the external event occurs, simply send the CT command which will trigger the execution of the already buffered sequence of commands.

*NOTE: It is possible to overflow the command buffer. Use the BS (Buffer Status) command to view how many command spaces are vacant in the buffer at any given time.*

### Command Details:

Structure	PS
Type	BUFFERED
Usage	WRITE ONLY
Non-Volatile	NO
Register Access	None

### Examples:

Command	Drive sends	Notes
PS	-	Pause execution of buffered commands

## PT - Pulse Type

Compatibility: All drives  
 See also: CM, EG commands

Sets or requests the type of incoming pulse used in CM7 (Pulse and Direction mode).

The possible input signals are as follows:

- 0 = Step / Direction
- 1 = CW / CCW Pulse
- 2 = AB Quadrature (master encoder)
- 4 = Step / ~Direction (direction input is reversed from PT0)
- 6 = BA Quadrature (count direction is reverse of PT2)

### Command Details:

Structure	PT{Parameter #1}
Type	BUFFERED
Usage	READ / WRITE
Non-Volatile	YES
Register Access	None

### Parameter Details:

Parameter #1	Pulse Type
- units	integer
- range	0, 1, 2, 4, or 6

### Examples:

Command	Drive sends	Notes
PT0	-	Instruct the drive to follow step/direction pulses from a master controller.
PT	PT=0	
PT2	-	Instruct the drive to follow AB quadrature encoder pulses, typically from a master encoder.
PT	PT=2	

## PV - Secondary Electronic Gearing

Compatibility: SV200 series servo drives only  
 Affects: Control mode 7  
 See also: EG, DS Commands

This parameter determines the second electronic gearing of SV200 drives. This secondary electronic gearing can be selected with the X9 digital input. See DS command or *SVX Servo Suite* for configuration of X9 input.

### Command Details:

Structure	PV{Parameter #1}
Type	BUFFERED
Usage	READ/WRITE
Non-Volatile	YES
Register Access	None

### Parameter Details:

Parameter #1	See above
- units	Integer(counts/rev)
- range	10~51200
-default	20000

### Examples:

Command	Drive sends	Notes
PV20000	%	set the second electronic gearing to 20000 counts/rev
PV	PV=20000	the second electronic gearing is 20000 counts/rev

## PW - Password

Compatibility: Q drives only

Normally the stored program of a Q drive can be uploaded and downloaded at will. This allows basically any user to access the stored program of a Q drive. To password-protect the stored program of a Q drive the PW command can be issued with a customized key code.

The factory default key code is “1234”, which allows uploading and downloading programs freely. To password-protect a stored program the user should enter the PW command with a new key code. This new key code can be any 4 character alpha-numeric code (characters A-Z, a-z, and 0-9 are acceptable). After entering the new key code the user must enter the SA (Save) command for the new key code to be saved in the drive. Then, the next time the drive is powered up password-protection will take effect, which means the user must first “unlock” the drive by sending the PW command with the customized key code before being able to upload (QU), save (QS), or delete (QD) any part of the Q drive’s stored program. (All other immediate commands function even if the drive is not “unlocked”). Furthermore, every subsequent power-up of the drive will require the same key code to be entered before uploading. To change the key code, enter the present key code at power up and then use the PW command to enter a new key code followed by the SA command. To return the drive to the default state of no-password protection, unlock the drive first by using the present key code, then enter the default key code of “1234” followed by the SA command.

*NOTE: If the key code is forgotten or lost, re-entering the default code of “1234” will unlock the drive and ERASE THE CONTENTS OF THE DRIVE’S NON-VOLATILE MEMORY AT THE SAME TIME.*

### Command Details:

Structure	PW(Parameter #1)
Type	IMMEDIATE
Usage	WRITE ONLY
Non-Volatile	Yes
Register Access	None

### Parameter Details:

Parameter #1	4-digit alphanumeric key code
- units	upper and lower-case letters and numbers
- range	A-Z, a-z, 0-9
- default	Default key code is “1234”

### Examples:

Command	Drive sends	Notes
PWak99	-	Password key code set to “ak99”
SA	-	New key code saved in drive
PWak99	-	Access to stored program unlocked at next power-up of drive

---

## QC - Queue Call

---

Compatibility: Q drives only

See also: QX, QE, QL commands

Loads a program segment from non-volatile memory into the queue and begins executing at line #1. Loads the “calling” segment location and the line where the call occurred into a call “stack”. When a QC command without a parameter is encountered in the segment a “return” to the calling segment is activated. The “calling” segment is loaded from non-volatile memory back into the queue and begins executing at the line immediately following the line number of the original “calling” QC command.

The call stack can go 5 calls deep which means you can nest up to 5 calls. If the number of calls before a “return” (QC with no parameter) is encountered exceeds 5 the “calling” QC command (with parameter) is ignored. If a “return” is encountered without a previous call, the return is ignored.

### Command Details:

Structure	QC{Parameter #1}
Type	BUFFERED
Usage	WRITE ONLY
Non-Volatile	NO
Register Access	None

### Parameter Details:

Parameter #1	Program segment, no parameter means return to calling segment
- units	integer
- range	1 - 12 = segment 1 - 12 no parameter = return to calling segment

### Examples:

Command	Drive sends	Notes
QC4	-	Call segment 4
QC	-	Return to calling segment



---

## QD - Queue Delete

---

Compatibility: Q drives only  
 See also: QL, QS, PW commands

Deletes the contents of the non-volatile memory location associated with a particular program segment.

### Command Details:

Structure	QD(Parameter #1)
Type	IMMEDIATE
Usage	WRITE ONLY
Non-Volatile	NO
Register Access	None

### Parameter Details:

Parameter #1	Segment number
- units	integer number
- range	1 - 12

### Examples:

Command	Drive sends	Notes
QD5	-	Delete program segment 5 from the drive's non-volatile memory

---

## QE - Queue Execute

---

Compatibility: Q drives only  
See also: QL, QX

Begins executing a program segment previously loaded into the queue. Starts executing at line #1. A segment must have previously been loaded using the “QL” or “QX” commands.

### Command Details:

Structure	QE
Type	IMMEDIATE
Usage	WRITE ONLY
Non-Volatile	NO
Register Access	None

### Examples:

Command	Drive sends	Notes
QE	-	Begin execution of loaded segment

---

## QG - Queue Goto

---

Compatibility: Q drives only  
 See also: QJ, QR

Causes program segment execution to jump to the given line number in the queue. Gotos directed to the same line number as the QG command or past the end of the queue are ignored.

### Command Details:

Structure	QG(Parameter #1)
Type	BUFFERED
Usage	WRITE ONLY
Non-Volatile	NO
Register Access	None

### Parameter Details:

Parameter #1	Segment line number
- units	integer
- range	1 - 62

### Examples:

Command	Drive sends	Notes
QG10	-	Cause a jump to line 10 in the segment

## QJ - Queue Jump

Compatibility: Q drives only  
 Affects: Program flow  
 See also: QG, TI, TR, CR and all Math commands (“R” commands)

Causes program segment execution to jump to the given line number in the queue based on a “condition code”. Jumps directed to the same line number as the QJ command or past the end of the queue are ignored. If the condition code is met the jump occurs, if not the program proceeds to the next line. Condition codes are set by previous commands such as the TI (Test Input) or TR (Test Register) commands. When using math commands (“R” commands) the condition code is set based on the result of the math operation.

### Command Details:

Structure	QJ(Parameter #1)(Parameter #2)
Type	BUFFERED
Usage	WRITE ONLY
Non-Volatile	NO
Register Access	None

### Parameter Details:

Parameter #1	Condition code
- units	letter
- range	T = True F = False P = Positive G = Greater than L = Less than E = Equals U = Unequal Z = Zero
Parameter #2	Segment line number
- units	integer
- range	1 - 62

### Examples:

Command	Drive sends	Notes
TI4L	-	Test input 4 to see if it's low (active)
QJT15	-	Jump to line 15 if condition code is “True” (i.e. input 4 is low)

---

## QK - Queue Kill

---

Compatibility: Q drives only  
Affects: Queue execution and program flow  
See also: SK

Halts execution of the queue. The queue contents are not affected and can be executed again using the “QE” command.

### Command Details:

Structure	QK
Type	BUFFERED
Usage	WRITE ONLY
Non-Volatile	NO
Register Access	None

### Examples:

Command	Drive sends	Notes
QK	-	Stop execution of the queue/program

---

## QL - Queue Load

---

Compatibility: Q drives only  
 Affects: Contents of command buffer  
 See also: QE, QS, QX commands

Initiates the loading of a command sequence into the queue. Loading can come from the serial port (host controller) or from non-volatile memory (stored program). When no parameter is sent with the command loading is done from the serial port. Loading is finished when a QS (Queue Save) or QE (Queue Execute) command is sent. When a parameter is sent with the command the parameter designates the non-volatile memory location of the desired program segment to be loaded into the queue. QL will cause an overwrite of any commands in the queue starting at line #1.

### Command Details:

Structure	QL{Parameter #1}
Type	IMMEDIATE
Usage	WRITE ONLY
Non-Volatile	NO
Register Access	None

### Parameter Details:

Parameter #1	Program segment number
- units	integer
- range	1 - 12

### Examples:

Command	Drive sends	Notes
QL	-	Initiates loading queue from serial port
QL3	-	Loads segment from non-volatile memory into the queue

## QR - Queue Repeat

Compatibility: Q drives only  
 Affects: Selected data register  
 See also: QJ, QG, RL, RX commands

Causes program segment execution to jump to a previous line number in the queue for a given number of repeat counts. The repeat count is acquired from a selected Read/Write or User-Defined data register. Jumps past the end of the queue are ignored. Jumps to subsequent line numbers in the queue will not be repeated. If repeat count is set to "1" no Jump is performed. The data register selected for the repeat count must be set with the number of repeat counts prior to using the QR command: use the RX (Register Load - buffered) command to load the data register with the repeat count. The data register contents are affected by this command and must be re-loaded before each usage with the QR command.

*NOTE: Although data registers A - Z can be used with the QR command it is not recommended. The QR command eventually destructs the data in a register by decrementing its value each time a jump is made in the repeat loop and could therefore lead to unexpected results in other parts of the program that make use of data registers A - Z.*

### Command Details:

Structure	QR(Parameter #1)(Parameter #2)
Type	BUFFERED
Usage	WRITE ONLY
Non-Volatile	NO
Register Access	None

### Parameter Details:

Parameter #1	Data register
- units	register character
- range	A - Z and all user-defined registers (listed in the Data Registers section)
Parameter #2	Segment line number
- units	integer
- range	1 - 62

### Examples:

Command	Drive sends	Notes
RX120	-	Load user register #1 with the value 20
(...)		
QR15	-	Cause a repeated jump to line 5 of the queue using the value (20) in data register #1 as the repeat count

## QS - Queue Save

Compatibility: Q drives only  
 Affects: None  
 See also: QE, QL, QX, PW commands

Saves a segment currently in the queue to a non-volatile memory location. Ends a QL (Queue Load) if one is in progress. See Appendix B for more details on this command, including its limitations.

### Command Details:

Structure	QS(Parameter #1)
Type	IMMEDIATE
Usage	WRITE ONLY
Non-Volatile	NO
Register Access	None

### Parameter Details:

Parameter #1	Program segment location
- units	integer
- range	1 - 12

### Examples:

Command	Drive sends	Notes
QS2	-	Save contents of queue to non-volatile memory location #2



## QU - Queue Upload

Compatibility: Q drives only  
 See also: QL, QE, QS, QX, PW commands

Uploads a stored program segment from the drive's non-volatile memory to the serial port. This command is used to retrieve stored program segments from the drive. When using this command the drive responds with either a "positive" or a "negative" response. A "positive" response consists of a normal acknowledge ("ack") followed by the contents of the requested program segment with each line number separated by a carriage return. Program segments 1 to 12 can be uploaded, as well as the contents of the queue. A "negative" response from the drive consists of a normal acknowledge ("ack") followed by one of four error codes: 0, -1, -2, or -3. A *negative acknowledge ("nack" / "?") will be sent from the drive if the command is not understood by the drive. See Appendix D for more information on acknowledge and negative acknowledge responses.*

Positive response format:

"ack" ("%")  
 First line = "QU##" where "##" = the number of lines in the segment + 1  
 Second line = command at line 1 of the segment  
 Next line = command at line 2 of the segment  
 ...  
 Last line = command at last line of segment

Negative Responses:

"ack" ("%")  
 QU0 = No segment at specified location  
 QU-1 = Program Running (Cannot upload at this time)  
 QU-2 = Upload currently in process  
 QU-3 = Password Protected (Protection must be unlocked using PW command)

### Command Details:

Structure	QU(Parameter #1)
Type	IMMEDIATE
Usage	READ ONLY
Non-Volatile	NO
Register Access	None

### Parameter Details:

Parameter #1	Program segment location
- units	integer
- range	1 - 12, or 0 to upload queue

### Examples:

Command	Drive sends	Notes
QU0	(queue contents)	Uploads contents of queue to the serial port
QU3	(segment #3 contents) location #3	Uploads contents of segment from non-volatile memory

## QX - Queue Load & Execute

Compatibility: Q drives only  
 Affects: Stored program flow  
 See also: QE, QL

Loads a program segment from non-volatile memory into the queue. Begins executing the segment at line #1. This is similar to the combination of a QL (Queue Load) and a QE (Queue Execute) command with the difference being the QX command can be written into a stored program segment. Use this command to “jump” from segment to segment.

### Command Details:

Structure	QX(Parameter #1)
Type	BUFFERED
Usage	WRITE ONLY
Non-Volatile	NO
Register Access	None

### Parameter Details:

Parameter #1	Program segment location
- units	integer
- range	1 - 12

### Examples:

Command	Drive sends	Notes
QX2	-	Loads segment #2 and begins execution

## RC - Register Counter

Compatibility: Q drives only  
 Affects: Data Register "I" (025)  
 See also: RL, RX , RI, RD, TS commands

This command enables a function that increments the "I" data register when the given input condition (determined by the RC command) is met. Typically the "R" or "F" input condition (see Details below) is used to trigger an increment. If however the "L" or "H" input condition is used the register will be incremented at a rate of 8000 times per second. In other words the "R" and "F" input conditions are used for true input counting while the "L" and "H" conditions act as input timers. Use the RL (Register Load - immediate) or RX (Register Load - buffered) commands to preset or set the "I" data register to a predetermined value. Sending the RC command without a parameter disables the function.

This command is also used in conjunction with the TS (Time Stamp) command. See the TS command for more details.

### Command Details:

Structure	RC{Parameter #1}
Type	BUFFERED
Usage	WRITE ONLY
Non-Volatile	NO
Register Access	"I" (025)

### Parameter Details:

(See Appendix F: Working With Inputs and Outputs)

### Examples:

Command	Drive sends	Notes
RC4F	- low (falling edge)	Increment data register "I" each time input 4 changes from high to

The sample Q program on the following page illustrates the interaction of the RC and TS commands. After initialization, the program waits for a falling edge event on input X3, at which point a 5 second timer begins counting down. During this delay, the user may trigger X3 an arbitrary number of times. After 5 seconds, the motor will execute a series of 5000-step moves, with the delay between each corresponding to the delay between switch closures on X3. That is, if the user trips X3 four times waiting 1 second between each event, the motor will execute four 5000-step moves with a 1 second dwell between each.

Sample Q program for illustrating RC and TS interaction

	MT	1		Multi-tasking ON
	EG	20000		20,000 steps/rev
	AC	250		
	DE	250		
	VE	5		
	FI	3	200	Filter input 3 for 200 processor ticks
	RX	I	0	Zero the "I" register
	RC	X3F		Setup the "I" register for input X3
	WI	X3F		Wait for input X3
	WT	5.00		Wait 5 seconds >>> trigger inpuxt X3 a few times
	TS			Throw away first time stamp
LABEL2	RD	I		Decrement "I" register
	FL	5000		Feed 5000 steps
	TR	I	1	Test "I" against 1
	QJ	L	#LABEL1	Jump to end if "I" less than 1
	TS			Time stamp
	RM	W	1	Move "W" into "1"
	WD	1		Delay for "1" milliseconds
	QG	#LABEL2		Go to Label 2
LABEL1	NO			Stop program

## RD - Register Decrement

Compatibility: Q drives only  
 Affects: All data registers  
 See also: RI, RM

Decrements by 1 the value of the designated data register.

### Command Details:

Structure	RD(Parameter #1)
Type	BUFFERED
Usage	WRITE ONLY
Non-Volatile	NO
Register Access	All Read/Write and User-Defined data registers

### Parameter Details:

Parameter #1	Data register assignment
- units	character
- range	all Read/Write and User-Defined data registers

### Examples:

Command	Drive sends	Notes
RDV	-	Decrements the value of the velocity data register "V"

---

## RE - Restart or Reset

---

Compatibility: All drives

Restarts the drive by resetting fault conditions and re-initializing the drive with the startup parameters. Leaves the drive in a disabled state to prevent any movement after the restart is complete.

### Command Details:

Structure	RE
Type	IMMEDIATE
Usage	WRITE ONLY
Non-Volatile	NO
Register Access	None

### Examples:

Command	Drive sends	Notes
RE	-	Resets drive condition and parameters

## RI - Register Increment

Compatibility: Q drives only  
 Affects: All data registers  
 See also: RD, RM commands

Increments by 1 the value of the designated data register.

### Command Details:

Structure	RI(Parameter #1)
Type	BUFFERED
Usage	WRITE ONLY
Non-Volatile	NO
Register Access	All Read/Write and User-Defined data registers

### Parameter Details:

Parameter #1	Data register assignment
- units	character
- range	all Read/Write and User-Defined data registers

### Examples:

Command	Drive sends	Notes
RIV	-	Increments the value of the velocity data register "V"

## RL - Register Load - immediate

Compatibility: All drives  
 Affects: All data registers  
 See also: RX, RI, RD, RM commands

Sets a data register to the given immediate data value. The data value is checked and stored as a Long word. When setting a Short-word register with the given Long-word data value only the lower word of the Long value is used.

### Command Details:

Structure	RL(Parameter #1){Parameter #2}
Type	IMMEDIATE
Usage	READ/WRITE
Non-Volatile	NO
Register Access	All data registers

### Parameter Details:

Parameter #1	Data register assignment
- units	character
- range	All Read/Write and User-Defined data registers; Read-Only data registers can be read back when Parameter #2 is not included
Parameter #2	Data register value
- units	integer
- range	+/- 2147483647 (long data registers) +/- 32767 (short data registers)

### Examples:

Command	Drive sends	Notes
RLA100	-	Set acceleration register to 1000 rpm/s
RLA	RLA=100	Return acceleration register value

When PR command Bit 5 is set

RL017100	-	Set Acceleration register to 1000 rpm/s
RL017	RLA=100	Return acceleration register value

NOTE: When setting a register no pre-processing of the data value is performed. Data is set to the internal raw value. For example, the internal raw acceleration value is in tens of rpm/s. See the "Data Register" section at the beginning of this manual for more details on data register assignments and units.

Units Example:

AC10 means 10 rps/s

RLA10 means 10 \* 10 rpm/s = 1.667 rps/s

Multiply the desired rps/s value times 6 to convert to the "raw" acceleration value



## RM - Register Move

Compatibility: Q drives only  
 Affects: All data registers  
 See also: RI, RD, RL, TR, RX commands

Move the contents of a first data register into a second data register.

### Command Details:

Structure	RM(Parameter #1)(Parameter #2)
Type	BUFFERED
Usage	WRITE ONLY
Non-Volatile	NO
Register Access	All Read/Write and User-Defined data registers

### Parameter Details:

Parameter #1	Source data register
- units	character
- range	all data register assignments
Parameter #2	Destination data register
- units	character
- range	all Read/Write and User-Defined data registers

### Examples:

Command	Drive sends	Notes
RMAB	-	Move contents of acceleration register "A" into the deceleration register "B"

---

## RO - Anti-Resonance ON

---

Compatibility: Stepper drives

Enables or disables the Anti-Resonance algorithm. This command has the same effect as the “Anti-Resonance off” check box in ST Configurator’s motor configuration dialog.

### Command Details:

Structure	RO{Parameter #1}
Type	BUFFERED
Usage	READ / WRITE
Non-Volatile	YES
Register Access	None

### Parameter Details:

Parameter #1	Anti-Resonance Algorithm Status
- units	integer
- range	0 (Anti-Resonance OFF) 1 (Anti-Resonance ON)

### Examples:

Command	Drive sends	Notes
RO1	-	Enable Anti-Resonance algorithm
RO	RO=1	
RO0	-	Disable Anti-Resonance algorithm
RO	RO=0	

## RR - Register Read

Compatibility: Q drives only  
 Affects: All data registers  
 See also: RI, RD, RL, RM, RW commands

Reads a data value from a non-volatile memory location into a data register. The data value is read as a Long word. If the value being read is too large for the destination data register, the value is truncated.

### Command Details:

Structure	RR(Parameter #1)(Parameter #2)
Type	BUFFERED
Usage	WRITE ONLY
Non-Volatile	NO
Register Access	All Read/Write and User-Defined data registers

### Parameter Details:

Parameter #1	Data register
- units	character
- range	all Read/Write and User-Defined data registers
Parameter #2	Non-volatile memory location
- units	integer
- range	1 - 100

### Examples:

Command	Drive sends	Notes
RRV10	- register "V"	Read data from non-volatile memory location #10 and place it in data

---

## RS - Request Status

---

Compatibility: All drives  
 See also: SC command

Asks the drive to respond with what it's doing. The drive has a number of different states of operation that are represented by character codes. The drive can send more than one code at a time to define its current status.

### Command Details:

Structure	RS
Type	IMMEDIATE
Usage	READ ONLY
Non-Volatile	NO
Register Access	None

### Examples:

Command	Drive sends	Notes
RS	RS=PR	Motor is in position, drive is enabled
RS	RS=AED	Alarm code is present, drive is faulted and disabled
RS	RS=JR	Motor is jogging, drive is enabled

Status character codes:

A = An Alarm code is present (use AL command to see code, AR command to clear code)

D = Disabled (the drive is disabled)

E = Drive Fault (drive must be reset by AR command to clear this fault)

F = Motor moving

H = Homing (SH in progress)

J = Jogging (CJ in progress)

M = Motion in progress (Feed & Jog Commands)

P = In position

R = Ready (Drive is enabled and ready)

S = Stopping a motion (ST or SK command executing)

T = Wait Time (WT command executing)

W = Wait Input (WI command executing)

## RU - Register Upload

Compatibility: Q drives only  
 Affects: All data registers  
 See also: PR, RL, RX commands

Upload the contents of an array of data registers. Up to 16 registers can be read back with one RU command. Each reading is terminated with a carriage return.

### Command Details:

Structure	RU(Parameter #1)(Parameter #2)
Type	IMMEDIATE
Usage	WRITE ONLY
Non-Volatile	NO
Register Access	All data registers

### Parameter Details:

Parameter #1	Data register assignment
- units	character
- range	all data registers
Parameter #2	Number of consecutive data registers to upload
- units	integer
- range	1 - 16

### Examples:

Command	Drive sends	Notes
RUA5	RUA=400 RUB=400 RUC=16000 RUD=8000 RUE=0	"A" The Acceleration value "B" The Deceleration value "C" The Distance Change value "D" The Distance value "E" The Encoder value

When PR command Bit 5 is set		
Command	Drive sends	Notes
RU0175	RUA=400 RUB=400 RUC=16000 RUD=8000 RUE=0	"017" The Acceleration value "018" The Deceleration value "019" The Distance Change value "020" The Distance value "021" The Encoder value

NOTE: All Data values are "raw" meaning the data is not scaled to the drive user units. For example the velocity value ("V") will be returned as 0.25 rpm instead of rps: raw value of 2400 = 10 rps.

---

## RV - Revision Level

---

Compatibility: All drives  
See also: MV command

Requests the drive's firmware version. Data is returned as a three digit value. To see the firmware version's sub-letter as well (if applicable) use the MV command.

### Command Details:

Structure	RV
Type	IMMEDIATE
Usage	READ ONLY
Non-Volatile	NO
Register Access	None
Units	Drive firmware version

### Examples:

Command	Drive sends	Notes
RV	RV=150	Drive is running firmware version 1.50

## RW - Register Write

Compatibility: Q drives only  
 Affects: All data registers  
 See also: RI, RD, RL, RM, RW commands

Writes the data value of a given data register into non-volatile memory. The data value is written as a Long word. See Appendix A for more details on this command, including its limitations.

*NOTE: The RW function writes information to flash memory, which has a useful life of 10,000 write cycles.*

### Command Details:

Structure	RW(Parameter #1)(Parameter #2)
Type	BUFFERED
Usage	WRITE ONLY
Non-Volatile	NO
Register Access	All Read/Write and User-Defined data registers

### Parameter Details:

Parameter #1	Data register assignment
- units	character
- range	all Read/Write and User-Defined data registers
Parameter #2	Non-volatile memory location
- units	integer
- range	1 - 100

### Examples:

Command	Drive sends	Notes
RWV10	-	Write data from data register "V" into non-volatile memory location #10

## RX - Register Load - buffered

Compatibility: Q drives only  
 Affects: All data registers  
 See also: RL, RU, RM commands

Sets a data register to the given immediate data value. The data value is checked and stored as a Long word. When loading a Short-word data register with the given Long-word data value only the lower word of the Long value is used. This command is the same as the RL command except it is a buffered command and therefore can be placed in a stored program.

### Command Details:

Structure	RX(Parameter #1)(Parameter #2)
Type	BUFFERED
Usage	READ/WRITE
Non-Volatile	NO
Register Access	All data registers

### Parameter Details:

Parameter #1	Data register assignment
- units	character
- range	All Read/Write and User-Defined data registers; Read-Only data registers can be used when Parameter #2 is not included (i.e. for reading back the contents of a Read-Only data register)
Parameter #2	Data register value
- units	integer
- range	+/- 2147483647 (long data registers) +/- 32767 (short data registers)

### Examples:

Command	Drive sends	Notes
RXA100	-	Set acceleration register "A" to 1000 rpm/s
RXA	RXA=100	



## R+ - Register Add

Compatibility: Q drives only  
 Affects: All data registers  
 See also: R-, R\*, R/, R&, RD, RI, QJ commands

Adds the contents of a first data register to a second data register and places the result in the accumulator data register, User-Defined register "0". This is a 32-bit operation: adding two Long word values can cause an overflow.

All math operations affect the "condition code" used by the QJ (Queue Jump) command. R+ can set condition codes T, F, N, P, and Z

### Command Details:

Structure	R+(Parameter #1)(Parameter #2)
Type	BUFFERED
Usage	WRITE ONLY
Non-Volatile	NO
Register Access	"0" (000), Accumulator

### Parameter Details:

Parameter #1	First data register assignment
- units	character
- range	all data registers
Parameter #2	Second data register assignment
- units	character
- range	all data registers

### Examples:

Command	Drive sends	Notes
R+D1	-	Add contents of distance register "D" to user-defined register "1" and place the result in the accumulator register "0"

## R- - Register Subtract

Compatibility: Q drives only  
 Affects: All data registers  
 See also: R+, R\*, R/, R&, RD, RI, QJ commands

Subtracts the contents of the second data register from the first data register and places the result in the accumulator data register, User-Defined register "0". This is a 32-bit operation: subtracting two Long word values can cause an underflow.

All math operations affect the "condition code" used by the QJ (Queue Jump) command. Can set condition codes T, F, N, P, and Z.

### Command Details:

Structure	R-(Parameter #1)(Parameter #2)
Type	BUFFERED
Usage	WRITE ONLY
Non-Volatile	NO
Register Access	"0" (000), Accumulator

### Parameter Details:

Parameter #1	First data register assignment
- units	character
- range	all data registers
Parameter #2	Second data register assignment
- units	character
- range	all data registers

### Examples:

Command	Drive sends	Notes
R-D1	-	Subtract the contents of user-defined register "1" from the distance register "D" and place the result in the accumulator register "0"

## R\* - Register Multiply

Compatibility: Q drives only  
 Affects: All data registers  
 See also: R+, R-, R/, R&, RD, RI, QJ commands

Multiply the contents of the first data register by the second data register and place the result in the accumulator data register, User-Defined register "0". This is a 32-bit operation: multiplying two Long word values can cause an overflow.

All math operations affect the "condition code" used by the QJ (Queue Jump) command. Can set condition codes T, F, N, P, and Z.

### Command Details:

Structure	R*(Parameter #1)(Parameter #2)
Type	BUFFERED
Usage	WRITE ONLY
Non-Volatile	NO
Register Access	"0" (000), Accumulator

### Parameter Details:

Parameter #1	First data register assignment
- units	character
- range	all data registers
Parameter #2	Second data register assignment
- units	character
- range	all data registers

### Examples:

Command	Drive sends	Notes
R*D1	-	Multiply contents of distance register "D" by contents of user-defined register "1" and place result in accumulator register "0"

## R/ - Register Divide

Compatibility: Q drives only  
 Affects: All data registers  
 See also: R+, R-, R\*, R&, RD, RI, QJ commands

Divide the contents of the first data register by the second data register and place the result in the accumulator data register, User-Defined register “0”. This is a 32-bit operation. A value of “zero” in the second data register will cause an illegal “divide by zero”, in which case the divide operation is ignored.

All math operations affect the “condition code” used by the QJ (Queue Jump) command. Can set condition codes T, F, N, P, and Z.

### Command Details:

Structure	R/(Parameter #1)(Parameter #2)
Type	BUFFERED
Usage	WRITE ONLY
Non-Volatile	NO
Register Access	“0” (000), Accumulator

### Parameter Details:

Parameter #1	First data register
- units	data register assignment
- range	All data registers
Parameter #2	Second data register
- units	data register assignment
- range	All data registers

### Examples:

Command	Drive sends	Notes
R/D1	-	Divide contents of distance register “D” by user-defined register “1” and place result in accumulator register “0”

## R& - Register AND

Compatibility: Q drives only  
 Affects: All data registers  
 See also: R+, R-, R\*, R/, RD, RI, QJ commands

Do a “bit-wise” AND of the contents of the first data register with the contents of the second data register and place the result in the accumulator data register, User-Defined register “0”. This is a 32-bit operation. This operation affects the “condition code” use by the QJ (Queue Jump) command.

All math operations affect the “condition code” used by the QJ (Queue Jump) command. Can set condition codes T, F, N, P, and Z.

### Command Details:

Structure	R&(Parameter #1)(Parameter #2)
Type	BUFFERED
Usage	WRITE ONLY
Non-Volatile	NO
Register Access	“0” (000), Accumulator

### Parameter Details:

Parameter #1	First data register
- units	data register assignment
- range	All data registers
Parameter #2	Second data register
- units	data register assignment
- range	All data registers

### Examples:

Command	Drive sends	Notes
R&s1	-	AND the contents of status register “s” and user-defined register “1” and place the result in accumulator register “0”

## R| - Register OR

Compatibility: Q drives only  
 Affects: All data registers  
 See also: R+, R-, R\*, R/, R&, RD, RI, QJ commands

Do a “bit-wise” OR of the contents of the first data register with the contents of the second data register and place the result in the accumulator data register, User-Defined register “0”. This is a 32-bit operation.

All math operations affect the “condition code” used by the QJ (Queue Jump) command. Can set condition codes T, F, N, P, and Z.

### Command Details:

Structure	RI(Parameter #1)(Parameter #2)
Type	BUFFERED
Usage	WRITE ONLY
Non-Volatile	NO
Register Access	“0” (000), Accumulator

### Parameter Details:

Parameter #1	First data register
- units	data register assignment
- range	All data registers
Parameter #2	Second data register
- units	data register assignment
- range	All data registers

### Examples:

Command	Drive sends	Notes
Rli1	-	OR the contents of inputs register “i” with user-defined register “1” and place the results in accumulator register “0”

---

## SA - Save Parameters

---

Compatibility: All drives  
 See Also: RE command

Saves selected command parameters to non-volatile memory. This command is useful for setting up the drive configuration with the desired defaults at power-up. (See which commands are non-volatile in the Command Summary section.)

NOTE: Excessive use of this command will wear out the NV memory. Use of this command within a Q program is not advised for this reason.

### Command Details:

Structure	SA
Type	BUFFERED
Usage	WRITE ONLY
Non-Volatile	NO
Register Access	None

### Examples:

Command	Drive sends	Notes
SA	-	Save all Non-Volatile-designated data registers

## SC - Status Code

Compatibility: All drives  
See also: RS command

Requests the current drive status as the Hexadecimal equivalent of a binary word. Each bit in the binary word relates to a status condition (see assignments below). The representation of this binary word as a hexadecimal value is called the Status Code. Drives can have multiple status conditions at one time, and host systems can typically interpret a Hexadecimal code very quickly. See Appendix E for more details on the Status Code.

### Command Details:

Structure	SC
Type	IMMEDIATE
Usage	READ ONLY
Non-Volatile	NO
Register Access	None
Units	Hexadecimal equivalent of the binary status code word (see bit assignments below)

### Response Details:

Hex Value	Status Code bit definition
0001	Motor Enabled (Motor Disabled if this bit = 0)
0002	Sampling (for Quick Tuner)
0004	Drive Fault (check Alarm Code)
0008	In Position (motor is in position)
0010	Moving (motor is moving)
0020	Jogging (currently in jog mode)
0040	Stopping (in the process of stopping from a stop command)
0080	Waiting (for an input; executing a WI command)
0100	Saving (parameter data is being saved)
0200	Alarm present (check Alarm Code)
0400	Homing (executing an SH command)
0800	Waiting (for time; executing a WD or WT command)
1000	Wizard running (Timing Wizard is running)
2000	Checking encoder (Timing Wizard is running)
4000	Q Program is running
8000	Initializing (happens at power up) ; Servo Ready (for SV200 drives only)

### Examples:

Command	Drive sends	Notes
SC	SC=0009	Drive is in position and enabled (hex values 0001 and 0008)
SC	SC=0004	Drive is faulted and disabled (hex value 0004)
SC	SC=0209	Drive has an alarm, is in position and enabled (hex values 0001, 0008, and 0200)



## SD - Set Direction

Compatibility: Integrated Steppers with Flex I/O  
 Affects: All input and output commands  
 See Also: AI, AO, BO, DL, MO and SI

The Flex I/O feature allows the user to specify the direction of each I/O point. That is, to configure each as either an input or output. SD may be used as a query if issued without a parameter. The drive will then report the direction of each I/O point.

**WARNING: The SD command allows dynamic changes to I/O behavior of the drive, and may cause unintended interactions with other machine components if not implemented properly. Extreme caution should be used. The SD command is documented here only for completeness; Applied Motion Products strongly recommends that the Configurator software be used to make changes to drive I/O behavior.**

### Command Details:

Structure	SD{Parameter #1}{Parameter #2}
Type	BUFFERED
Usage	READ/WRITE
Non-Volatile	Yes
Register Access	None

### Parameter Details:

Parameter #1	I/O point to configure
- units	Integer
- range	1 - 4
Parameter #2	Direction (input or output)
- units	Single character
- range	'I' or 'O' (letter 'O', not zero)

*NOTE: This command requires either the letter 'I' (input) or 'O' (output) as Parameter #2. The drive's response however, is composed of the numbers 1 (one = input) or 0 (zero = output).*

### Examples:

Command	Drive sends	Notes
SD2O	-	Set I/O point 2 as an Output
SD4I	-	Set I/O point 4 as an Input
SD	SD=00000111	Drive reports that I/O points 1, 2 and 3 are inputs, 4 is an output. (Note: on the STM24, I/O points 5-8 are unused)

---

## SF - Step Filter Frequency

---

Compatibility: Stepper drives only

Sets or requests the step filter frequency. The primary use of this filter is to introduce “microstep emulation” effects, which smooth out low resolution step pulses when the drive’s microstep/gearing resolution (EG command) is set to a low value. This command is exceptionally useful when using a low-resolution indexer and smooth motor shaft rotation is required.

### Command Details:

Structure	SF{Parameter #1}
Type	BUFFERED
Usage	READ/WRITE
Non-Volatile	Yes
Register Access	None

### Parameter Details:

Parameter #1	Step filter frequency
- units	Hz
- range	0 - 2500

### Examples:

Command	Drive sends	Notes
SF500	-	Set step filter frequency to 500 Hz
SF	SF=500	

## SH - Seek Home

Compatibility: All drives  
 See Also: DL, FD, FS, FY, MT commands

Executes the seek home command. Requires input number and condition for the home sensor. Speed is set by the last VE command. Accel and decel are set by AC and DE. Direction comes from the sign of the last DI command (“-” is CCW, no sign is CW).

It should be noted that the SH command is not affected by multitasking. It will execute as shown here regardless of the current MT setting. Please see the MT command for details.

The SH command performs a number of operations all combined into one command. The basic operation acts like a combination of the FS (Feed to Sensor) and FP (Feed to Position) commands. First, an FS-like move is made that runs the motor until the drive “sees” the home sensor. When the drive sees this home sensor it does two things: it records the absolute position of the home sensor and it immediately starts decelerating the motor to a stop. After the motor has come to a stop the drive then does an FP-like move to move the motor back to the absolute position recorded for the home sensor. Another function of the SH command is that if an end-of-travel limit switch is encountered before the home sensor condition is met, the move direction is reversed until the opposite limit is found. After the opposite limit is found the move then returns to the original direction and again attempts to find the home sensor. This always ensures that the motor is moving in the desired direction when the drive sees the home sensor.

*NOTE: This command is designed for use with three physical sensors or switches tied to three separate digital inputs of the drive: a home sensor, a CW end-of travel limit, and a CCW end-of-travel limit.*

### Command Details:

Structure	SH{Parameter #1}
Type	BUFFERED
Usage	WRITE ONLY
Non-Volatile	NO
Register Access	None

### Parameter Details:

(See Appendix F: Working With Inputs and Outputs)

### Examples:

Command	Drive sends	Notes
SH1L	-	Seek home to input 1 low
SH3R	-	Seek home to input 3 rising edge
SHX5L	-	Seek home to input X5 low (main driver board input)

*NOTE: It may be necessary to add an ‘X’ in front of the input number ‘0’ when using the Seek Home command with the encoder index (X0) as Param1. This is necessary on BLu servo drives.*

---

## SI - Enable Input Usage

---

Compatibility: All drives  
Affects: Enable input usage  
See also: AI, CM, SD commands

### BLu, SV, STAC6, ST-Q/Si

Sets or requests the usage of the Enable input. Input X3 is the default Enable input on all drives, however IN3 on SE, QE and Si drives may also be designated as the Enable input (see below). If an external Enable function is not needed input X3 and/or IN3 can be defined solely as a general purpose input. In this scenario only the ME and MD commands will enable and disable the drive, respectively. When using the brake output (see BO, BD and BE commands) the disabling of the drive is delayed by the time value set using the BD command.

There are five possible usage states for the Enable function:

- SI1: Drive is enabled when X3 is open (inactive, high).
- SI2: Drive is enabled when X3 is closed (active, low).
- SI3: Neither X3 nor IN3 is used for enabling/disabling the drive, but as general purpose inputs.
- SI4: Drive is enabled when IN3 is open (inactive, high). (SE, QE, and Si drives only).
- SI5: Drive is enabled when IN3 is closed (active, low). (SE, QE, and Si drives only).

### ST-S, STM17, STM23-Q/C, STM24-C

Defines the EN input as an Enable Input. If you want to use the EN input as an Enable input you can define it as such in two ways, with the *ST Configurator* software, or with the SI command. SI takes no effect if the drive is set in Command Mode (CM) 13, 14, 17 or 18, because these modes use the EN input as a speed change input and take precedence over the SI command. Also, setting the AI command after setting the SI command reassigns the EN input to Alarm Reset usage and turns off any drive enable usage (SI3). In other words, the AI and SI commands, as well as Command Modes (CM) 13, 14, 17 and 18 each assign a usage to the EN input. Each of these must exclusively use the EN input. Note: The STM24-C drive uses IN3 for the Enable Input.

There are three Enable input states that can be defined with the SI command:

- SI1: Drive is enabled when the EN input is open (inactive, high).
- SI2: Drive is enabled when the EN input is closed (active, low).
- SI3: The EN input is not used for Enable and can be used as a general purpose input. SI will be automatically set to 3 if CM is set to 13, 14, 17, or 18, or if AI is set to 1 or 2 after the SI command is set.

### STM24-SF/QF

Drives with Flex I/O allow a second parameter which allows the user to specify the I/O point used. Before an I/O point can be used as the Drive Enable input it must first be configured as an input with the SD command. See the STM24 Hardware Manual for details of which inputs may be used as the Drive Enable input.

Possible uses for the SI command on the STM24 are as follows ('n' denotes the I/O point to be used):

- SI1n: Drive is enabled when the designated input is open (inactive, high).
- SI2n: Drive is enabled when the designated input is closed (active, low).
- SI3n: The specified input ('n') is not used for Drive Enable and may be used as a general purpose input.

## STAC5-S, SVAC3-S

Defines the X3 input as an Enable Input. If you want to use the X3 input as an Enable input you can define it as such in two ways, with the ST Configurator software, or with the SI command. SI takes no effect if the drive is set in Command Mode (CM) 13, 14, 17 or 18, because these modes use the X3 input as a speed change input and take precedence over the SI command. Also, setting the AI command after setting the SI command reassigns the X3 input to Alarm Reset usage and turns off any drive enable usage (SI3). In other words, the AI and SI commands, as well as Command Modes (CM) 13, 14, 17 and 18 each assign a usage to the X3 input. Each of these must exclusively use the X3 input.

There are three Enable input states that can be defined with the SI command:

SI1: Drive is enabled when the X3 input is open (inactive, high).

SI2: Drive is enabled when the X3 input is closed (active, low).

SI3: The X3 input is not used for Enable and can be used as a general purpose input. SI will be automatically set to 3 if CM is set to 13, 14, 17, or 18, or if AI is set to 1 or 2 after the SI command is set.

## Command Details:

Structure	SI{Parameter #1} {Parameter #2 (Flex I/O only)}
Type	BUFFERED
Usage	READ/WRITE
Non-Volatile	Yes
Register Access	None

## Parameter Details:

Parameter #1	Input Usage
- units	integer code
- range	1 - 3 or 1 - 5 (see above)
Parameter #2 (Flex I/O only)	I/O Point (if applicable, see note below)
- units	Integer Code
- range	1 or 3 (See STM24 Hardware Manual for details)

### NOTES:

- For drives with Flex I/O, the SD command must be executed to set an I/O point as an input or output before it can have a dedicated function assigned to it.
- Parameter #2 only applies to drives equipped with Flex I/O. This includes the STM24SF and STM24QF. Parameter #2 is not defined for drives equipped with standard I/O.

## Examples:

### All drives with standard I/O:

Command	Drive sends	Notes
SI1	-	Cause drive to be enabled when X3 / EN input is open
SI	SI=1	

### Drives with Flex I/O:

Command	Drive sends	Notes
SD3I	-	Configures I/O 3 as input (see SD command for details)
SI13	-	Cause drive to be enabled when Input 3 is open
SI	SI=13	

---

## SJ - Stop Jogging

---

Compatibility: All drives  
Affects: CJ command  
See Also: JA, CJ, ST, SK, SM commands

Stops the motor when jogging (CJ starts jogging). Jog decel rate is defined by the JA command.

### Command Details:

Structure	SJ
Type	IMMEDIATE
Usage	WRITE ONLY
Non-Volatile	NO
Register Access	None

### Examples:

Command	Drive sends	Notes
SJ	- command	Stops jogging immediately using the deceleration rate set by the JA

## SK - Stop & Kill

Compatibility: All drives

See Also: AM, DE, JA, ST, SM commands

Halts any buffered command in progress and removes any other buffered commands from the queue. When used to stop a move deceleration rate is controlled by the AM (Max Acceleration) parameter. If the “D” parameter is used deceleration rate is controlled by either DE (with “Feed” moves like FL, FP, SH) or JA (when jogging).

### Command Details:

Structure	SK{Parameter #1}
Type	IMMEDIATE
Usage	WRITE ONLY
Non-Volatile	NO
Register Access	None

### Parameter Details:

Parameter #1	Deceleration rate
- units	letter
- range	D = deceleration rate set by DE or JA command no parameter = deceleration rate set by AM command

### Examples:

Command	Drive sends	Notes
SK	-	Stop motion immediately using the deceleration rate set by the AM command and erase the contents of the queue
SKD	-	Stop motion immediately using the deceleration rate set by the DE command (or JA if jogging) and erase the contents of the queue

## SM - Stop Move

Compatibility: Q drives only

See also: AM, DE, JL, SK, ST, QK commands

Stops any type of move in progress\* such as FL or CJ. This command acts like the ST (Stop) command except it will not stop a wait operation (like WD, WI, WP, or WT) and it can be part of a stored Q program. The contents of the queue are not affected by the SM command

\* = Exception: SH

*NOTE: Requires Multi-Tasking to be enabled (MT1). By default Motion-Tasking is disabled, which means the current move must complete before any subsequent buffered command (such as SM) can execute. With Multi-Tasking enabled, subsequent commands may be processed while a move is in progress and the SM command will execute properly.*

### Command Details:

Structure	SM(Parameter #1)
Type	BUFFERED
Usage	WRITE ONLY
Non-Volatile	NO
Register Access	None

### Parameter Details:

Parameter #1	Deceleration rate
- units	letter
- range	D = deceleration rate set by DE command or JL command (if jogging) M = deceleration rate set by AM command

### Examples:

Command	Drive sends	Notes
SMD	-	Stop motion immediately using the deceleration rate set by the DE command or the JL command (if jogging)
SMM	-	Stop motion immediately using the deceleration rate set by the AM command



---

## SO - Set Output

---

Compatibility: All drives

See Also: IL, IH, IO commands

Sets an output to the given condition. Care must be taken when using outputs on the main driver board because those outputs are by default programmed for dedicated purposes (Alarm, Brake, Motion). Use the AO, BO and MO commands to reconfigure main driver board output usage to general purpose before using the SO command with those outputs.

### Command Details:

Structure	SO(Parameter #1)
Type	BUFFERED
Usage	WRITE ONLY
Non-Volatile	NO
Register Access	None

### Parameter Details:

(See Appendix F: Working With Inputs and Outputs)

### Examples:

Command	Drive sends	Notes
SO1L	-	Set output 1 low (closed)
SO2H	-	Set output 2 high (open)
SOY1L	-	Set main driver board output 1 low (closed)
SOY2H	-	Set main driver board output 2 high (open)

---

## SP - Set Position

---

Compatibility: All drives  
 Affects: FP commands  
 See Also: EP, FP commands

Sets or requests the motor's absolute position. To ensure that the internal position counter resets properly, use EP immediately prior to sending SP. For example, to set the position to zero after a homing routine, send EP0 immediately followed by SP0.

*Note that EP is not supported and, therefore, not required for ST5/10-S and ST5/10-Plus drives.*

### Command Details:

Structure	SP{Parameter #1}
Type	BUFFERED
Usage	READ/WRITE
Non-Volatile	NO
Register Access	None

### Parameter Details:

Parameter #1	Absolute position
- units	encoder counts
- range	+/- 2,147,483,647

### Examples:

Command	Drive sends	Notes
SP100	-	Set absolute position offset to 100 encoder counts
SP	SP=100	
EP0	-	(Step 1) reset internal position counter
SP0	-	(Step 2) reset internal position counter

## SS - Send String

Compatibility: All drives with RS-232 communication

Instructs drive to respond with the desired character string (up to 4 characters). This command is useful for letting the host system know via the serial port when a sequence of commands has finished executing. Multiple SS commands can be placed into the queue at any time, though care should be taken when using this command to avoid serial data collisions. For example, the host system should avoid sending commands to the drive while expecting a character string (from a previously buffered SS command).

*NOTE: Due to the possibility of data collisions related to unscheduled communication from slave devices, this command is nonfunctional for RS-485 drives.*

### Command Details:

Structure	SS(Parameter #1)
Type	BUFFERED
Usage	WRITE ONLY
Non-Volatile	NO
Register Access	None

### Parameter Details:

Parameter #1	String of characters
- units	any printable characters
- range	up to 4 characters

### Examples:

Command	Drive sends	Notes
SSdone	done	String "done" sent when SS command is executed

## ST - Stop

Compatibility: All drives  
 See Also: SK, SM commands

Halts the current buffered command being executed, but does not affect other buffered commands in the command buffer. When used to stop a move deceleration rate is controlled by the AM (Max Acceleration) command. If a "D" parameter is used deceleration rate is controlled by either the DE command (with "Feed" moves like FL, FP, and SH) or the JL\* command (when jogging).

\*Note that setting the JA command also sets the JL command. If distinct JA and JL values are required always set JL after setting JA.

### Command Details:

Structure	ST{Parameter #1}
Type	IMMEDIATE
Usage	WRITE ONLY
Non-Volatile	NO
Register Access	None

### Parameter Details:

Parameter #1	Deceleration rate
- units	letter
- range	D = deceleration rate set by DE or JA command no parameter = deceleration rate set by AM command

### Examples:

Command	Drive sends	Notes
ST	- command	Stop motion immediately using the deceleration rate set by the AM
STD	- JA command	Stop motion immediately using the deceleration rate set by the DE or

## TD - Transmit Delay

Compatibility: All drives  
 Affects: RS-232 & RS-485 Serial Communications  
 See Also: BR, PB & PR commands

Sets or requests the time delay used by the drive when responding to a command that requests a response. Typically this is needed when using the 2-wire RS-485 interface (Half-duplex). Because the same wires are used for both receive and transmit a time delay is usually needed to allow transition time. The Host device's RS-485 specification must be understood to determine the time delay needed.

### Command Details:

Structure	TD{Parameter #1}
Type	BUFFERED
Usage	READ/WRITE
Non-Volatile	Yes
Register Access	None

### Parameter Details:

Parameter #1	Time value
- units	milliseconds
- range	0 - 32767
- default	10

### Examples:

Command	Drive sends	Notes
TD10	-	Set Tx time delay to 10 milliseconds
TD	TD=10	

## TI - Test Input

Compatibility: Q drives only  
 Affects: Condition Code  
 See also: QJ, TR commands

Tests a digital or analog input against the given input state. If the input is in the state the condition code is set to “T” (true). If not the condition code is set to “F” (false). The condition code is found in read-only register ‘h’ and is most commonly used in conditional jump (QJ) commands. The input is tested, and the jump is performed only if that input is in a specific state.

### Command Details:

Structure	TI(Parameter #1)
Type	BUFFERED
Usage	WRITE ONLY
Non-Volatile	NO
Register Access	None

### Parameter Details:

(See Appendix F: Working With Inputs and Outputs)

### Examples:

Command	Drive sends	Notes
TI4L	-	Test input 4 for a low state
QJT15	-	Jump to line 15 if the previously tested input is “True”

## TO - Tach Output

Compatibility: TSM and SV200 servo drives only  
 Affects: TSM-P output Y3, TSM-S/Q output Y4, and SV200 output Y6  
 See also: MO command

Defines and configures the tach pulse output function and resolution for the appropriate digital output on a TSM integrated StepSERVO motor or SV200 servo drive.

Note: This command is only supported on TSM and SV200 models. See corresponding hardware manual and software for additional details.

TO parameter list for TSM-P (output Y3) and TSM-S/Q (output Y4):

- 3: Output is not used as a Motion Output and can be used for a general purpose output.
- 4: Output is used as a Tach Output at 100 pulses/rev.
- 5: Output is used as a Tach Output at 200 pulses/rev.
- 6: Output is used as a Tach Output at 400 pulses/rev.
- 7: Output is used as a Tach Output at 800 pulses/rev.
- 8: Output is used as a Tach Output at 1600 pulses/rev.
- 12: Output is closed (energized) when motor is not moving(static in-position).
- 13: Output is open (de-energized) when motor is not moving(static in-position).

TO parameter list for SV200 servo drive (output Y6):

- 0 = 1 \* pole pairs
- 1 = 2 \* pole pairs
- 2 = 4 \* pole pairs
- 3 = 8 \* pole pairs
- 4 = 16 \* pole pairs
- 5 = 32 \* pole pairs
- 6 = 64 \* pole pairs
- 7 = 128 \* pole pairs

For “pole pairs” use a value of 4 for all J series servo motors.

### Command Details:

Structure	TO(Parameter #1)
Type	BUFFERED
Usage	READ/WRITE
Non-Volatile	YES
Register Access	None

### Parameter Details:

Parameter #1	Output Usage (see above)
- units	integer code
- range	see above

## Examples:

For TSM:

Command	Drive sends	Notes
TO12	-	Motion Output will close when the motor is not moving
TO	TO=12	

For SV200:

Command	Drive sends	Notes
TO6	-	Tach Output will output 256 pulses/rev
TO	TO=6"	



## TR - Test Register

Compatibility: Q drives only  
 Affects: All data registers  
 See also: CR, TI, RI, RD, RM, RL, QJ commands

Tests a data register against a given data value. The result of the test is the setting of the condition code, which can be used for conditional programming (see QJ command).

All conditions codes can be set by this command. See “QJ” command for more details.

### Command Details:

Structure	TR(Parameter #1)(Parameter #2)
Type	BUFFERED
Usage	WRITE ONLY
Non-Volatile	NO
Register Access	All data registers

### Parameter Details:

Parameter #1	Data register
- units	data register assignment
- range	All data registers
Parameter #2	Test value
- units	integer
- range	+/- 2,147,483,647 (long data registers) +/- 32,767 (short data registers)

### Examples:

Command	Drive sends	Notes
TR15	-	Test user-defined register “1” against the value 5

## TS - Time Stamp

Compatibility: Q drives only  
 Affects: Data Register “W”  
 See also: RC, WD, All register commands

Transfers the oldest Time Stamp value from the time stamp buffer into the “W” data register. The time stamp value is a time value in milliseconds, recorded between two input triggers when using the RC command. Each time a defined input condition is “True” (triggered), the elapsed time from the previous input is stored in the time stamp buffer. The time stamp buffer is 8 words deep and acts as a FIFO buffer. The “I” data register, used by the RC command, records when an input trigger has occurred. Sending the RC command clears the time stamp buffer. Executing the TS command removes the oldest time value from the time stamp buffer and places it in the “W” Data Register where it can be used. With each execution of the TS command a time value is transferred, until the end of the time stamp buffer is reached. If a TS is sent with no time values in the time stamp buffer a “0” is placed in the “W” data register.

### Command Details:

Structure	TS
Type	BUFFERED
Usage	WRITE ONLY
Non-Volatile	NO
Register Access	“W” (039)
Units	milliseconds

### Example:

This sample Q program illustrates the interaction of the RC and TS commands. After initialization, the program waits for a falling edge event on input X3, at which point a 5 second timer begins counting down. During this delay, the user may trigger X3 an arbitrary number of times. After 5 seconds, the motor will execute a series of 5000-step moves, with the delay between each corresponding to the delay between switch closures on X3. That is, if the user trips X3 four times waiting 1 second between each event, the motor will execute four 5000-step moves with a 1 second dwell between each.

```

MT      1           Multi-tasking ON
EG      20000      20,000 steps/rev
AC      250
DE      250
VE      5
FI      3          200      Filter input 3 for 200 processor ticks
RX      I          0       Zero the “I” register
RC      X3F       Setup the “I” register for input X3
WI      X3F       Wait for input X3
WT      5.00      Wait 5 seconds >>> trigger input X3 a few times
TS      Throw away first time stamp
LABEL2  RD      I       Decrement “I” register
FL      5000      Feed 5000 steps
TR      I          1       Test “I” against 1
QJ      L          #LABEL1 Jump to end if “I” less than 1
TS      Time stamp
RM      W          1       Move “W” into “I”
WD      1          Delay for “1” milliseconds
QG      #LABEL2    Go to Label 2
LABEL1  NO        Stop program
    
```

## TT - Pulse Complete Timing

Compatibility: SSM, TSM, TXM, SS, SSAC and SV200 series servo drives

This parameter is used to define a time duration. It is used to determine whether the driver has finished receiving all pluses or not. If the drive does not receive any pluses for the period that is longer than TT defined time, then the pulse input stream to the drive is considered complete.

### Command Details:

Structure	TT{Parameter #1}
Type	BUFFERED
Usage	READ/WRITE
Non-Volatile	YES
Register Access	None

### Parameter Details:

Parameter #1	Pulse Complete Timing
- units	50 $\mu$ sec, (125 $\mu$ sec for SV200)
- range	5~20000
-default	2000

### Examples:

Command	Drive sends	Notes
TT1000	-	Sets the pulse complete timing to 50ms for pulse receive complete determination.
TT	TT=1000	

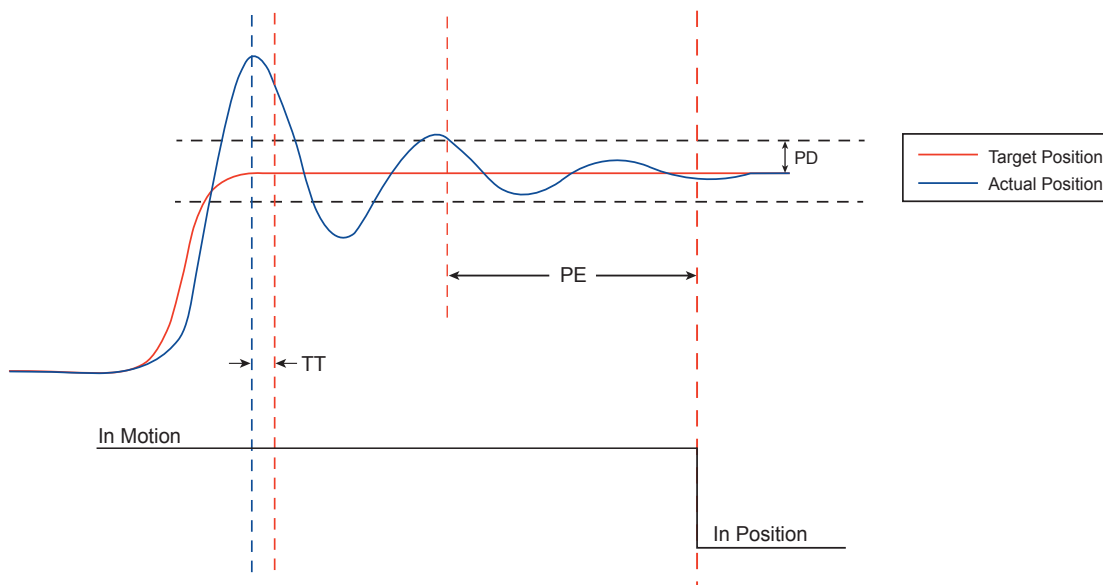

## TV - Torque Ripple

Compatibility: SV200 series servo drives only  
 Affects: Output Y3 in torque mode  
 See also: MO, PE command

Defines the acceptable torque ripple value around the targeted torque in units of Amperes. If the difference between the actual torque and targeted torque is within the ripple value for the time duration specified by PE command, then the drive defines the actual torque as having met the target torque value. This setting is one of the parameters that controls when the “torque reached” output, which is assigned to digital output Y3, will change state while operating in torque mode.

### Command Details:

Structure	TV{Parameter #1}
Type	BUFFERED
Usage	READ/WRITE
Non-Volatile	YES
Register Access	None

### Parameter Details:

Parameter #1	See above
- units	Amps
- range	0~4.50
-default	0

### Examples:

Command	Drive sends	Notes
TV1	%	Set the torque ripple around the targeted torque to 1Amps
TV	TV=1	The torque ripple around the targeted torque is 1Amps

---

## VC - Velocity Change

---

Compatibility: All drives  
 Affects: FC, FD commands

Sets or requests the “change speed” for FC and FD moves..

### Command Details:

Structure	VC{Parameter #1}
Type	BUFFERED
Usage	READ/WRITE
Non-Volatile	Yes
Register Access	“U” (037)

### Parameter Details:

Parameter #1	Move velocity
- units	rev/sec
- range	BLu, SV, STAC6, ST-Q/Si, ST-S: 0.0042 - 133.3333 (resolution is 0.0042) STM: 0.0042 - 80.0000 (resolution is 0.0042)

### Examples:

Command	Drive sends	Notes
VC5	-	Set change velocity to 5 rev/sec
VC	VC=5	

---

## VE - Velocity

---

Compatibility: All drives

Affects: FC, FD, FE, FL, FM, FS, FP, FY, SH commands

Sets or requests shaft speed for point-to-point move commands like FL, FP, FS, FD, SH, etc.

### Command Details:

Structure	VE{Parameter #1}
Type	BUFFERED
Usage	READ/WRITE
Non-Volatile	Yes
Register Access	"V" (038)

### Parameter Details:

Parameter #1	Move velocity
- units	rev/sec
- range	BLu, STAC6, : 0.0042 - 133.3333 (resolution is 0.0042)  SV200 series, SV7, SVAC3: 0.0042 - 136 (resolution is 0.0042)  SSM, TSM, TXM: 0.0042 - 60 (resolution is 0.0042)  ST-Q/Si, ST-S, ST-Plus, STM, STAC5, SWM: 0.0042 - 80.0000 (resolution is 0.0042)

### Examples:

Command	Drive sends	Notes
VE2.525	-	Set move velocity to 2.525 rev/sec
VE	VE=2.525	

## VI - Velocity Integrator Constant

Compatibility: Servo drives only  
 Affects: Jog commands  
 See also: VP & JM commands

Sets or requests the velocity-mode (“JM2”) servo control integrator gain term. Gain value is relative: 0 = no gain, 32767 = full gain. VI minimizes steady state velocity errors.

### Command Details:

Structure	VI{Parameter #1}
Type	BUFFERED
Usage	READ/WRITE
Non-Volatile	Yes
Register Access	None

### Parameter Details:

Parameter #1	Velocity integrator gain value
- units	integer (no specific units)
- range	0 - 32767 (0% - 100%)

### Examples:

Command	Drive sends	Notes
VI5000	-	Set velocity integrator gain to 5000
VI	VI=5000	

## VL - Voltage Limit

Compatibility: High-voltage Stepper Drives (STAC5, STAC6 only)

Specifies the maximum voltage that will be applied to the motor by the PWM outputs on the drive.

Normally this is set to 100% for modern step motors. Some inexpensive motors are constructed with less robust winding insulation, and require this voltage to be limited. In these rare cases, VL may be lowered. This will directly impact motor performance, but will allow the drive to control a wider variety of motors.

### Command Details:

Structure	VL{Parameter #1}
Type	BUFFERED
Usage	READ / WRITE
Non-Volatile	YES
Register Access	None

### Parameter Details:

Parameter #1	PWM Duty Cycle
- units	
- range	10 - 1000 (1.0% - 100.0%)

### Examples:

Command	Drive sends	Notes
VL1000	-	Maximum voltage applied to the motor: 100.0% (default)
VL	VL = 1000	
VL500	-	Maximum voltage applied to the motor: 50.0%
VL	VL=500	



## VM - Maximum Velocity

Compatibility: Servo drives  
 Affects: Analog Velocity mode  
 See Also: AM, VC, VE commands

Sets or requests the maximum motor velocity in rev/sec. Used in analog velocity mode to limit the maximum speed of the drive.

### Command Details:

Structure	VM{Parameter #1}
Type	BUFFERED
Usage	READ/WRITE
Non-Volatile	YES
Register Access	None

### Parameter Details:

BLu, SV

Parameter #1	Move velocity
- units	rev/sec (rps)
- range	0.0042 - 133.3333 (resolution is 0.0042 rev/sec)

### Examples:

Command	Drive sends	Notes
VM50	-	Set maximum move velocity to 50 rev/sec
VM	VM=50	

## VP - Velocity Mode Proportional Constant

Compatibility: Servo drives only  
 Affects: Jog commands  
 See also: VI & JM commands

Sets or requests the velocity-mode servo control Proportional gain term. Gain value is relative: 0 = no gain, 32767 = full gain. VP minimizes velocity error when in velocity mode 2 (see JM command).

### Command Details:

Structure	VP{Parameter #1}
Type	BUFFERED
Usage	READ/WRITE
Non-Volatile	Yes
Register Access	None

### Parameter Details:

Parameter #1	Velocity mode proportional gain
- units	integer
- range	0 - 32767 (0% - 100%)

### Examples:

Command	Drive sends	Notes
VP5000	-	Set velocity mode proportional gain to 5000
VP	VP=5000	

## VR - Velocity Ripple

Compatibility: SV200 series servo drives only  
 Affects: Output Y4  
 See also: MO, PE commands

Defines the acceptable velocity ripple value around the targeted velocity in units of rev/sec. If the difference between the actual velocity and targeted velocity is within the ripple value, then the drive defines the actual velocity as having met the target velocity value. This setting is one of the parameters that controls when the “velocity reached” output, which is assigned to digital output Y4, will change state while operating in torque or velocity modes.

### Command Details:

Structure	VR{Parameter #1}
Type	BUFFERED
Usage	READ/WRITE
Non-Volatile	YES
Register Access	None

### Parameter Details:

BLu, SV

Parameter #1	Velocity Ripple (see above)
- units	rps
- range	0~136

### Examples:

Command	Drive sends	Notes
VR1	%	Set the velocity ripple around the targeted velocity to 1rps
VR	VR=1	The velocity ripple around the targeted velocity is 1rps

---

## WD - Wait Delay

---

Compatibility: Q drives only  
 Affects: None  
 See also: WI, RX commands

Causes a time delay to occur using a time value from a given data register. The resolution is in milliseconds. Only up to 15 bits of the data register are used, giving a maximum wait time of 32 seconds.

### Command Details:

Structure	WD(Parameter #1)
Type	BUFFERED
Usage	WRITE ONLY
Non-Volatile	NO
Register Access	None

### Parameter Details:

Parameter #1	Data register
- units	data register assignment
- range	All Read/Write and User-Defined data registers

### Examples:

Command	Drive sends	Notes
WD5	-	Wait the number of milliseconds indicated by the value in user-defined data register "5"

---

## WI - Wait for Input

---

Compatibility: All drives  
 Affects: Use of “Jog” Inputs  
 See Also: FI, JE, JD, WD, WM, TI commands

Waits for an input to reach the given condition. Allows very precise triggering of moves if a WI command is followed by a move command. When JE (Jog Enable) is active the drive’s “jog” inputs can be used to jog the motor. JD disables jogging using inputs. (See your drive’s User’s Manual for designation of “jog” inputs).

### Command Details:

Structure	WI(Parameter #1)
Type	BUFFERED
Usage	WRITE ONLY
Non-Volatile	NO
Register Access	None

### Parameter Details:

(See Appendix F: Working With Inputs and Outputs)

### Examples:

Command	Drive sends	Notes
WI3R	-	Wait for input 3 to go high (rising edge) before proceeding to the next command in the queue

---

## WM - Wait on Move

---

Compatibility: Q drives only  
Affects: Queue execution  
See also: MT

When in multi-tasking is turned on (see MT command) this command will block execution of subsequent commands until the previously initiated move is complete. This can be any type of move such as “Feeds”, “Jogging” or the “Hand Wheel” (encoder following).

### Command Details:

Structure	WM
Type	BUFFERED
Usage	WRITE ONLY
Non-Volatile	NO
Register Access	None

### Examples:

Command	Drive sends	Notes
WM	- complete	Causes queue execution to wait until any move in progress is

## WP - Wait Position

Compatibility: Q drives only  
 Affects: Multi-velocity, or complex, move profiles  
 See Also: FC, DC, VC, MT commands

When multi-tasking is turned on (“MT1”), this command is used in conjunction with the DC command to block program execution until a specific position(s) is reached during a move. When the position(s) specified by the DC command is reached program execution continues.

### Common example:

This command is used as a “separator” in changing the motor speed of multi-velocity move profiles created using the FC command. The normal FC command provides for one speed change using values determined by DC and VC commands executed prior to the FC command. Additional speed changes can be added after an FC command is initiated by using the WP command to separate additional DC and VC commands. See the example below.

NOTE: This command, along with the ability to create multi-velocity move profiles with the FC command, is only available in BLu servo drive firmware revisions 1.53C or later. This command is available in all firmware revisions of STAC stepper drives.

### Command Details:

Structure	WP
Type	BUFFERED
Usage	WRITE ONLY
Non-Volatile	No
Register Access	None

### Examples:

Command	Drive sends	Notes
DI100000	-	Overall move distance set to 100,000 counts
VE10	-	Initial move speed set to 10 rps
DC80000	-	1st change distance set to 80,000 counts
VC15	-	1st change speed set to 15 rps
FC	-	Initiate FC command (complex move)
WP	-	
DC60000	-	2nd change distance set to 60,000 counts
VC9	-	2nd change speed set to 9 rps
WP	-	
DC40000	-	3rd change distance set to 40,000 counts
VC1	-	3rd change speed set to 1 rps
WP	-	
DC20000	-	4th change distance set to 20,000 counts
VC19	-	4th change speed set to 19 rps

---

## WT - Wait Time

---

Compatibility: All drives

See also: WD command

Causes a time delay in seconds. The resolution is 0.01 seconds with the largest value being 320.00 seconds.

### Command Details:

Structure	WT(Parameter #1)
Type	BUFFERED
Usage	WRITE ONLY
Non-Volatile	NO
Register Access	None

### Parameter Details:

Parameter #1	Time
- units	seconds
- range	0.00 - 320.00 (resolution is 0.01 seconds)

### Examples:

Command	Drive sends	Notes
WT2.25	-	Causes time delay of 2.25 seconds



## ZC - Regen Resistor Continuous Wattage

Compatibility: BLuAC5 and STAC6 drives only

Sets or requests the regeneration resistor wattage value. BLuAC and STAC drives dynamically calculate the continuous wattage induced into an external regeneration resistor and must know the continuous wattage rating of the regen resistor to do this effectively.

### Command Details:

Structure	ZC{Parameter #1}
Type	BUFFERED
Usage	READ/WRITE
Non-Volatile	Yes
Register Access	None

### Parameter Details:

Parameter #1	Continuous wattage value of regen resistor
- units	Watts
- range	1 - 1000

### Examples:

Command	Drive sends	Notes
ZC250	-	External regen resistor with value of 250 continuous watts is connected to the drive

---

## ZR - Regen Resistor Value

---

Compatibility: BLuAC5 and STAC6 drives only

Sets or requests the regeneration resistor value. BLuAC and STAC drives dynamically calculate the continuous wattage induced into an external regeneration resistor and must know the value of the regen resistor to do this effectively.

### Command Details:

Structure	ZR{Parameter #1}
Type	BUFFERED
Usage	READ/WRITE
Non-Volatile	Yes
Register Access	None

### Parameter Details:

Parameter #1	Value of regen resistor
- units	Ohms
- range	25 - 100

### Examples:

Command	Drive sends	Notes
ZR50	-	50 ohm external regen resistor connected to drive

## ZT - Regen Resistor Peak Time

Compatibility: BLuAC5 and STAC6 drives only

Sets or requests the regeneration resistor time constant. Decides the peak time that the resistor can tolerate full regeneration voltage. When regeneration occurs the full regeneration voltage of 400 volts is applied across the resistor. The peak wattage is typically very high, for example with the built-in 40 ohm resistor the peak wattage is 4000 Watts. Power resistors will tolerate this for only a brief period of time. In the case of the built-in 40 ohm/ 50 Watt regen resistor it is only 0.3125 seconds. The ZT value provides the resistor time constant used to create the “filter” for calculating average wattage in the regen resistor.

### Command Details:

Structure	ZT{Parameter #1}
Type	BUFFERED
Usage	READ/WRITE
Non-Volatile	Yes
Register Access	None

### Parameter Details:

Parameter #1	Maximum time for peak regen
- units	0.25 milliseconds
- range	1 - 32000

### Examples:

Command	Drive sends	Notes
ZT1250	-	Regen resistor peak time set to 0.3125 seconds
ZT	ZT=1250	

# Data Registers

Many of the commands listed in this reference function by transferring data to a drive for later use. These data values are stored in data registers within the drive and remain there until new commands change the values or power is removed from the drive. For example, if you send the Velocity command “VE10”, a maximum move speed of 10 rev/sec is placed in the data register for velocity. You can then execute as many FL (Feed to Length), FP (Feed to Position) or FS (Feed to Sensor) move commands as you’d like without sending another VE command: the move speed of 10 rev/sec will remain in the velocity data register until you change it.

In addition to the data register for velocity, there are registers for move acceleration (AC command, “A” register), deceleration (DE command, “B” register) and move distance (DI command, “D” register). There are also registers for limit sensors (DL command), motor current (CC command), encoder resolution (ER command), motor position (SP command) and encoder position (EP command). There are 75 data registers in all. See the following Data Register Assignments section for a complete listing of data registers available in your drive.

Not all commands function by transferring a data value into a register. Conversely, not all data registers are associated with a command. To access data registers that are not associated with a command, you can use a register’s unique character assignment. See the Data Register Assignments on the following pages for a listing of data registers and their character assignments. When accessing a data register using its character assignment you use the RL (Register Load Immediate) or RX (Register Load Buffered) commands. These commands allow you to load data values into a register as well as read back the contents of a data register. For example, we set the move speed to 10 rev/sec in the first paragraph of this page by using the velocity command “VE10”. You can accomplish the same thing by using the RL command and the character assignment for the velocity data register, “V”. By sending “RLV2400” to the drive (see units of “V” register in Data Register Assignments section) you set the move speed to 10 rev/sec.

There are four categories of data registers available with your drive: Read-Only, Read/Write, User-Defined, and Storage. The last two categories, User-Defined and Storage, are only for use with Q drives.

## Read-Only data registers

Read-Only data registers are predefined registers that contain information about drive parameters, settings, and states. These include registers for commanded current, encoder position, analog input levels, drive temperature, internal bus voltage, and more. You cannot transfer data values to a Read-Only data register; you can only read the contents of them (see RL and RX commands). Read-Only registers are assigned to lower-case letters.

## Read/Write data registers

Read/Write data registers are predefined registers that contain drive and move parameters that can be set by the user. These parameters include acceleration rate, velocity, move distance, continuous current setting, peak current setting, and more. Many of the Read/Write registers are associated with a particular command, so you can read their contents or load data into them with RL, RX, or that parameter’s particular command. Read/Write registers are assigned to upper-case letters.

## User-Defined data registers

User-Defined data registers are read/write registers that are not predefined. These registers are only used with Q drives. They allow you to create more flexible and powerful Q programs through math functions, incrementing and decrementing, conditional processing, and more. These registers are assigned to single-digit numbers and other ASCII characters.

## Storage data registers

Each Q drive comes with 100 non-volatile Storage data registers, which can be used to save the contents of other data registers to non-volatile memory. For example, since none of the User-Defined data registers are non-volatile, a user may want to save the values of some of these registers to memory. This can be done by transferring their values to Storage registers (called Writing) before power down of the drive. Then at the next

power up, these values can be loaded back into the User-Defined registers from the Storage registers (called Reading). Each Storage register can save one data register value, and the Storage registers are numbered 1 to 100. See the RR, RW, and SA commands as well as the Appendix for more information on accessing this section of memory.

## Using Data Registers

The diagram below shows how a drive's serial port accesses the different volatile (Read-Only, Read/Write, User-Defined) and non-volatile (Storage) data registers within a drive. The user can Load and Upload data register values using the RL, RX, and RU commands via the drive's serial port(s). Read-Only data registers can be uploaded but not loaded. For Q drives only, non-volatile memory is available for data registers in the form of Storage registers. Moving the contents of the volatile data registers back and forth between the non-volatile Storage registers is done with the RW and RR commands. See below for more details.

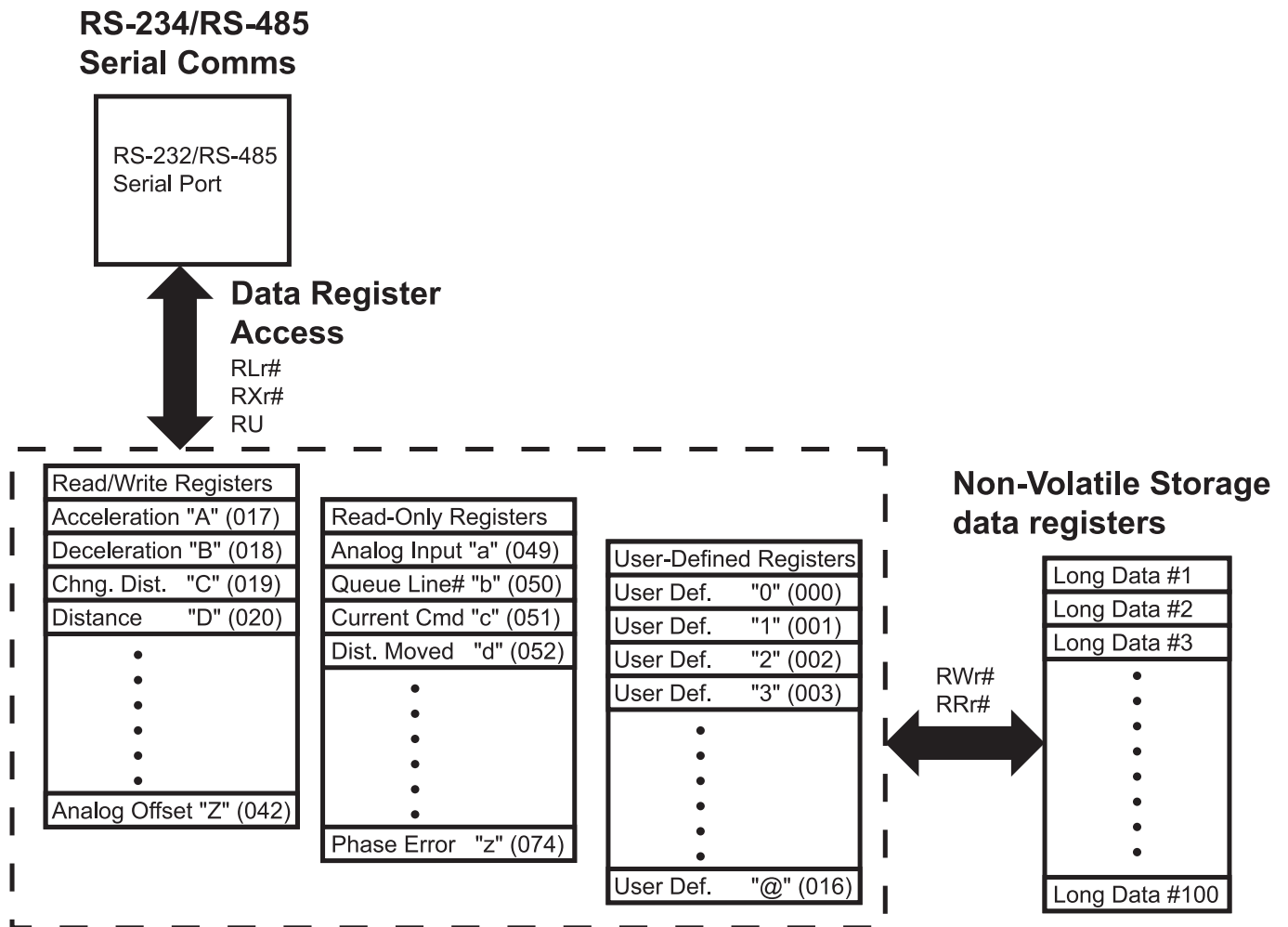

## Loading (RL, RX)

Accessing data registers is done by Loading data into a register, and Uploading data from a register. Loading a data register can be done from a host command line or from a line in a program. To load a register from a host command line use the RL (Register Load) command. This command can be executed at any time, even while a drive is running a program. The RL command is an immediate command. To load a register within a Q program use the RX command, which is a buffered version of Register Load.

## Uploading (RL, RU)

Uploading data registers can only be done from a host command line, not within a program. There are two commands available for uploading register values. RL is used to upload one register value at a time, while RU can be used to upload a single register value or an array of register values. Both RL and RU are immediate commands, and therefore can be executed while a program is running. The RU command can request up to 10 data register values in sequence back from the drive. This is great when an array of information is required at one time.

## Writing Storage registers (RW) (*Q drives only*)

Writing a data register allows the user to store data register values in non-volatile memory. To write a data register we use the RW (Register Write) command. There are 100 storage locations for data registers in NV memory. Note that the user must keep track of where data registers are stored because the NV memory locations are not associated with any specific data register.

## Reading Storage registers (RR) (*Q drives only*)

Reading a data register allows the user to move data previously saved in NV memory into a data register. To read a data register we use the RR (Register Read) command. Reading is typically done in the midst of a Q program.

The following sub-sections describe additional usage of data registers within Q drives only.

## Moving data registers (RM) (*Q drives only*)

Data register values can be moved from one register to another. This is done with the RM (Register Move) command. When executing an RM command, the contents of the originating data register are retained. Contents of read-only registers can be moved into read/write registers and user-defined registers. However, as implied by its label, no register values can be moved into read-only registers. Attempting to do so will have no effect and no error code is generated.

## Incrementing/Decrementing (RI, RD) (*Q drives only*)

Read/write and user-defined registers can be incremented and decremented by "1". Two commands are used for these functions: the RI (Register Increment) and RD (Register Decrement) command. NOTE: Incrementing past the range of a data register will cause the value to wrap around.

## Counting (RC, "I" register) (*Q drives only*)

A special data register, the "I" register (Input Counter), is designated for counting input transitions and input state times of a selected digital input. The "I" register is a read/write register that can be used with all other register functions including math and conditional testing.

The RC (Register Counter) command is used to assign digital inputs to register counting. There are four different input states that can be chosen and that have different effects on input counting. When using the "high" or "low" level states the counter acts as a "timer" with a resolution of 100 microseconds (SV servo drives and all stepper drives) or 125 microseconds (BLu servo drives). Edge type states like "falling" or "rising" are used for input counting. (See details of the RC command in the Q Command Reference).

## Math & Logic (R+, R-, R\*, R/, R&, R|) (*Q drives only*)

Math and logic functions can be performed on data registers. Math is limited to integer values. Some of the math functions are also limited to 16-bit values. When doing math only one operation can be done per instruction. Math and logic results are stored in the Accumulator register, "0". This register is part of the user-defined register set. Math functions include Add, Subtract, Multiply and Divide. Logic functions include Logical AND and Logical OR.

## Conditional Testing (CR, TR) (*Q drives only*)

When constructing complex programs it is usually necessary to do some conditional processing to affect program flow. Two commands are available for evaluating a data register for conditional processing, the TR (Test Register) and CR (Compare Register) commands. The TR command will compare the “First” value of a given data register against a “Second” immediate value. The CR command compares the “First” value of a given data register against the “Second” value of another data register. When using the TR and CR commands an internal “Condition” register is set with the result. The result can be:

“True”	the “First” value is either positive or negative
“False”	the “First” value is not a value (it’s zero)
“Zero”	the “First” value equals “0”
“Positive”	the “First” value is “positive”
“Negative”	the “First” value is “negative”
“Greater Than”	the “First” value is more positive than the “Second” value
“Less Than”	the “First” value is more negative than the “Second” value
“Equal to”	the “First” and “Second” values are equal
“Unequal to”	the “First” and “Second” values are not equal

NOTE: The QJ (Queue Jump) command is designed to use the “Condition Codes” above for jumping. The Condition Code can also be accessed via the “h” register.

## Data Register Assignments

What follows is a listing of all the data registers available with Applied Motion drives. In the tables below, “Ch.” denotes the data register’s character assignment, and “Description” gives the name of the data register. The column “3-digit” denotes the register’s 3-digit equivalent numerical assignment (see PR command, bit 5); “Data Type” designates whether the data register is a 16-bit word (Short) or a 32-bit word (Long); “Units” shows how a data register’s contents are used by the drive; and, “Compatibility” shows which drives can make use of the given register.

NOTE: When programming a Q drive with the Q Programmer software only the character assignment of the register can be used. When communicating to a Q drive via one of its serial ports, either the character assignment or the 3-digit numerical assignment can be used.

### Read-Only data registers: a - z

Many of the Read-Only data registers can be read with a specific command. In the tables below, associated commands are shown in parentheses in the “Description” column.

Ch.	Description	3-digit	Data Type	Units	Compatibility
<b>a</b>	Analog Command value (IA)	049	Short	BLu, SV, STAC6, ST-Q/Si: 32760 = +10V; -32760 = -10V ST-S, STM: 16383 = +5V; 0 = 0V*	All drives

\*Note that the “a” register is affected by the AV (Analog Offset) command, so the range may vary beyond 0 to 16383.

<b>b</b>	Queue Line Number	050	Short	Line # 1 - 62	Q drives only
----------	-------------------	-----	-------	---------------	---------------

<b>c</b>	Current Command (IC)	051	Short	Servo: 0.01 amps RMS Stepper: 0.01 amps, peak-of-sine	All drives
<b>d</b>	Relative Distance (ID)	052	Long	Servo: encoder counts Stepper: steps	All drives

**BLu, STAC6**

The “d” register (as well as the ID command) contains the relative move distance used in the last move. This means that the “d” register is only updated at the end of every relative move.

**SV, ST-Q/Si, ST-S, STM**

The “d” register (as well as the ID command) contains the immediate relative distance moved since the start of the last or current relative move. This means the “d” register is updated during relative moves and can therefore be polled during a move to see where the motor is with respect to the overall relative move distance.

<b>e</b>	Encoder Position (IE, EP)	053	Long	encoder counts	Servo drives and stepper drives with encoders
----------	---------------------------	-----	------	----------------	---

The “e” register can be zeroed by sending the command EP0.

<b>f</b>	Alarm Code (AL)	054	Long	hexadecimal equivalent of binary Alarm Code word (See AL command for details)	All drives
<b>g</b>	Sensor Position	055	Short	Servo: encoder counts Stepper: steps	All drives

The “g” register contains the absolute position of the point at which the input condition is met during moves like FS, FE, SH, and other “sensor-type” moves. It is common practice to use the EP and SP commands to establish known absolute positions within an application or program, which will make the value of the “g” register most meaningful. Otherwise, the absolute position of the motor is zeroed at every power-up of the drive.

<b>h</b>	Condition Code	056	Short	decimal equivalent of binary word (see below)	Q drives only
----------	----------------	-----	-------	--	---------------

The response to the “RLh” command will be the decimal equivalent of the condition code’s binary word. Bit assignments and examples are shown below.

Description	Bit #	Decimal Value
TRUE (non-zero)	0	1
FALSE (zero)	1	2
POSITIVE	2	4
NEGATIVE	3	8
GREATER THAN	4	16
LESS THAN	5	32
EQUAL TO	6	64
UNEQUAL TO	7	128



Example: Command RLh	Drive Sends RLh=149	Notes Bits 7 (UNEQUAL TO), 4 (GREATER THAN), 2 (POSITIVE) and 0 (TRUE) are set. Within a Q program the programmer will often have more than one condition to choose from when using the QJ command. The condition FALSE in Q Programmer is represented by bit 0 = 0 (opposite of TRUE).
----------------------------	------------------------	--

<b>i</b>	Driver Board Inputs (ISX)	057	Short	decimal equivalent of binary bit pattern (see below)	All drives
----------	---------------------------	-----	-------	--	------------

Details when executing the “RLi” command:

**BLu, STAC6**

The bit pattern of the “i” register breaks down as follows: bit 0 is the state of the encoder’s index (Z) channel, also known as input X0; bits 1 - 7 represent the states of driver board inputs X1 - X7, respectively; bits 8 - 10 represent the states of driver board outputs Y1 - Y3, respectively; and, bits 11 - 15 are not used. For bits 0 - 7 (inputs X0 - X7), a state of “1” means the optically isolated input is open, and a state of “0” means the input is closed. It is the exact opposite for bits 8 - 10 (outputs Y1 - Y3), for which a state of “1” means the optically isolated output is closed, and a state of “0” means the output is open.

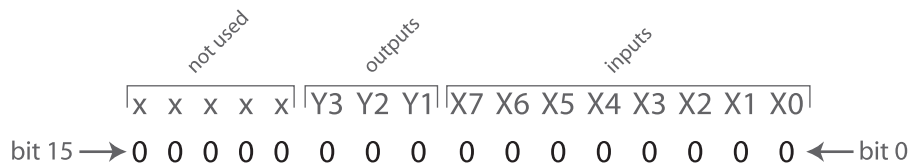

**SV, ST-Q/Si**

The bit pattern of the “i” register breaks down as follows: bits 0 - 7 represent inputs X1 - X8, respectively; bits 8 - 11 represent outputs Y1 - Y4, respectively; and, bit 12 is the encoder index channel (if present). For bits 0 - 7 and 12 (inputs X1 - X8 and the Index), a state of “1” means the optically isolated input is open, and a state of “0” means the input is closed. It is the exact opposite for bits 8 - 11 (outputs Y1 - Y4), for which a state of “1” means the optically isolated output is closed, and a state of “0” means the output is open.

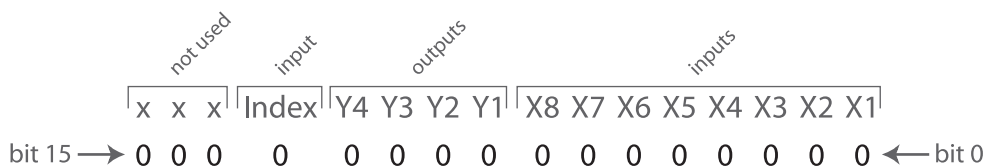

**ST-S, STM**

The bit pattern of the “i” register breaks down as follows: bit 0 represents the encoder index channel (if present), bit 1 represents the STEP input, bit 2 the DIR input, and bit 3 the EN input. Bit 8 represents the drive’s single output, OUT. For bits 0 - 3 (Index, STEP, DIR, and EN inputs), a state of “1” means the optically isolated input is open, and a state of “0” means the input is closed.

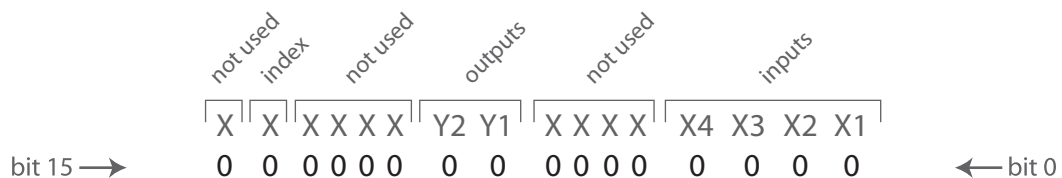

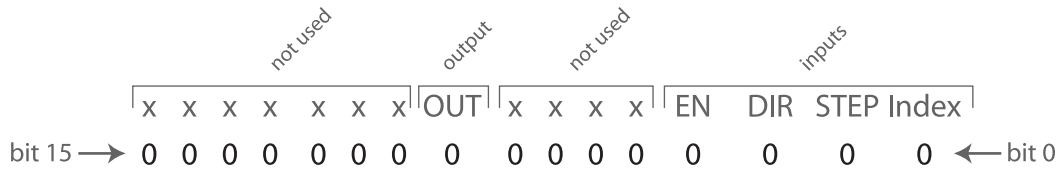

**SVAC3, STAC5**

The bit pattern of the “i” register breaks down as follows: bits 0-3 represent inputs X1-X4, respectively; bits 8 and 9 represent outputs Y1 and Y2, and bit 14 represents the encoder index channel (if present). represents the STEP input, bit 2 the DIR input, and bit 3 the EN input. Bit 8 represents the drive’s single output, OUT. For bits 0-3 and 14 (X1-X4 and the Index), a state of “1” means the optically isolated input is open, and a state of “0” means the input is closed.

<b>j</b>	Analog Input 1 (IA1)	058	Short	raw ADC counts, 0 - 32760 16383 = 0 volts for BLu, SV, STAC6, ST-Q/Si drives	All drives
<b>k</b>	Analog Input 2 (IA2)	059	Short	raw ADC counts, 0 - 32760 16383 = 0 volts	BLu, SV, STAC6, ST-Q/Si only
<b>l</b>	Immediate Absolute (trajectory) Position	060	Long	Encoder counts (servo), or motor steps (stepper).	All drives
<b>m</b>	Command Mode (CM)	061	Short	Mode #	All drives
<b>n</b>	Velocity Move State	062	Short	State # (see below)	All drives

Response details to the “RLn” command:

Description	Decimal Value	Comment
WAITING	0	In velocity mode waiting for a command
RUNNING	1	Doing a velocity move (jogging)
FAST STOPPING	2	Stopping a velocity move (ST or SK with no parameter)
STOPPING	3	Stopping a velocity move (SJ, STD, or SKD)
ENDING	4	Clean up at end of move (1 PWM cycle, 62 usec)

<b>o</b>	Point-to-Point Move State	063	Short	State # (see below)	All drives
----------	---------------------------	-----	-------	---------------------	------------

**NOTE:** The Point-to-Point Move State is only defined during FL, FP, and FS commands.

Details when using “RLo” command:

Description	Decimal Value	Comment
WAITING	0	In position mode waiting for command
WAITING ON BRAKE	1	Waiting for brake to release
CALCULATING	2	Doing the calculations for the move
ACCELERATION	3	Accelerating up to speed
CHANGE VELOCITY	4	Changing the speed (accel or decel)
AT_VELOCITY	5	At the desired speed
DECELERATION	6	Decelerating to a stop
FAST DECELERATION	7	Doing a fast deceleration (ST or SK)
POSITIONING	8	Clean up at end of move (1 PWM cycle, 62 usec)

<b>p</b>	Segment Number	064	Short	Segment # 1 - 12	Q drives only
<b>q</b>	Actual Motor Current (IQ)	065	Short	0.01 Amps	Servo drives only
<b>r</b>	Average Clamp Power	066	Short	Watts	BLuAC5, STAC6

<b>s</b>	Status Code (SC)	067	Short	hexadecimal equivalent of binary Status Code word (See SC command for details)	All drives
<b>t</b>	Drive Temperature (IT)	068	Short	0.1 °C	All drives
<b>u</b>	Bus Voltage (IU)	069	Short	0.1 Volts	All drives
<b>v</b>	Actual Velocity (IV0)	070	Short	0.25 rpm	Servo drives and stepper drives with encoder
<b>w</b>	Target Velocity (IV1)	071	Short	0.25 rpm	All drives*

\*For stepper drives, the “w” register is only updated when Stall Detection or Stall Prevention is turned on.

<b>x</b>	Position Error (IX)	072	Long	encoder counts	Servo drives and stepper drives with encoder
<b>y</b>	Expanded Inputs (IS)	073	Short	bit pattern	BLu, STAC6

Details when executing the “RLy” command:

#### BLu, STAC6, SVAC3 and STAC5 drives

The bit pattern of the “y” register breaks down as follows: bits 0 - 7 represent the states of top board inputs 1 - 8, respectively; bits 8 - 11 represent the states of driver board outputs 1 - 4, respectively; and, bits 12 - 15 are not used. For all I/O bits 0 - 11 (inputs 1 - 8 and outputs 1 - 4), a state of “1” means the optically isolated input or output is open, and a state of “0” means the input or output is closed. Bit 15 represents the ID bit, which simply holds a 1 if the IN/OUT2 or screw terminal I/O board is present and a 0 if it's not. In other words, for SE, QE and Si drives the ID bit will equal 1. For S and Q drives the ID bit will equal 0.

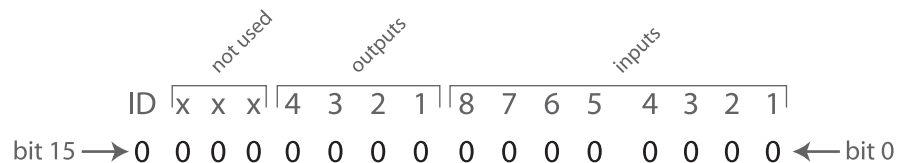

For example, if top board inputs 3 and 5 and top board outputs 1 and 2 were all closed, the response of the drive to the command “RLi” would be “RLi=-29461” (1000 1100 1110 1011). For a more efficient use of the “y” register it is recommended to mask off the ID bit and the other three not used bits. This can be done by using the R& (Register AND) command with the “y” register and a User Defined register set with the value 4095 (0000 1111 1111 1111). Following a register AND operation (&), this will reject the top 4 bits, leaving the rest of the data untouched. For example, the command sequence would look like this.

```

RL14095      Load User Defined register “1” with the value 4095
R&y1         Register AND the “y” and “1” registers
RL0          Request the value stored in the Accumulator register “0” to which the
              drive’s response would be RL0=3307.
  
```

<b>z</b>	Phase Error	074	Short	encoder counts	Servo drives only
----------	-------------	-----	-------	----------------	-------------------

## Read/Write data registers: A - Z

Many of the Read/Write data registers are associated with a specific command. In the tables below, associated commands are shown in parentheses in the “Description” column.

*NOTE: When using registers pay attention to units. In the case of some Read/Write registers, the units of the register when using the RL and RX command are different than when using the same register's associated command. For example, the “V” register uses units of 0.25 rpm, but its associated command, VE, uses revs/sec (rps). The reason for this difference is that all registers operate with integer math. On the other hand, when using commands it is often possible to include decimal places which allow for more user-friendly units.*

Ch.	Description	3-digit	Data Type	Units	Compatibility
<b>A</b>	Acceleration (AC)	017	Short	10 rpm/sec	All drives

The “A” register units are 10 rpm/sec, which means that the value of the “A” register is equal to 6 times the AC command value. In other words, to achieve an acceleration value of 100 rev/sec/sec send the command RLA600.

*NOTE: Take care to ensure that this register is never set to zero. The drive may become stuck in a command mode or program loop and/or refuse to move. See the RL, RM, and RX commands.*

<b>B</b>	Deceleration (DE)	018	Short	10 rpm/sec	All drives
----------	-------------------	-----	-------	------------	------------

The “B” register units are 10 rpm/sec, which means that the value of the “B” register is equal to 6 times the DE command value. In other words, to achieve a deceleration value of 100 rev/sec/sec send the command RLB600.

*NOTE: Take care to ensure that this register is never set to zero. The drive may become stuck in a command mode or program loop and/or refuse to move. See the RL, RM, and RX commands.*

<b>C</b>	Change Distance (DC)	019	Long	counts	All drives
<b>D</b>	Distance (DI)	020	Long	counts	All drives
<b>E</b>	Position Offset	021	Long	counts	Drives with encoder feedback option

The “E” register contains the difference between the encoder count and the motor position. This value is most useful with servo drives (BLu / SV) where the resolution of the motor and encoder are the same, and this offset can be useful when working with absolute positions. The register contains the difference in counts between the “e” register and the value set by the “SP” command.

<b>F</b>	Other Flags	022	Long	bit pattern (see below)	All drives
----------	-------------	-----	------	-------------------------	------------

### BLu

The value of the “F” register is a hexadecimal sum of various drive states, as shown below.

Description	Hex Value	Decimal Value
DISTANCE LIMIT FLAG	0x0001	1
SENSOR FOUND FLAG	0x0002	2
LOWSIDE OVERCURRENT	0x0004	4
HIGHSIDE OVERCURRENT	0x0008	8

Clear flags by sending “RLF0” to the drive.

### SV

The value of the “F” register is a hexadecimal sum of various drive states, as shown below.

Description	Hex Value	Decimal Value
DISTANCE LIMIT FLAG	0x0001	1
SENSOR FOUND FLAG	0x0002	2
LOWSIDE OVERCURRENT	0x0004	4
HIGHSIDE OVERCURRENT	0x0008	8
OVER CURRENT READING	0x0010	16
BAD CURRENT OFFSET - Phase A	0x0020	32
BAD CURRENT OFFSET - Phase B	0x0040	64
BAD FLASH ERASE	0x4000	16384
BAD FLASH SAVE	0x8000	32768

Clear flags by sending “RLF0” to the drive.

#### STAC6

The value of the “F” register is a hexadecimal sum of various drive states, as shown below.

Description	Hex Value	Decimal Value
DISTANCE LIMIT FLAG	0x0001	1
SENSOR FOUND FLAG	0x0002	2
HARDWARE OVERCURRENT	0x0004	4
SOFTWARE OVERCURRENT	0x0008	8
BAD CURRENT OFFSET - Phase A	0x0010	16
BAD CURRENT OFFSET - Phase B	0x0020	32
OPEN WINDING - Phase A	0x0040	64
OPEN WINDING - Phase B	0x0080	128

Clear flags by sending “RLF0” to the drive.

#### ST-Q/Si, ST-S, STM

The value of the “F” register is a hexadecimal sum of various drive states, as shown below.

Description	Hex Value	Decimal Value
DISTANCE LIMIT FLAG	0x0001	1
SENSOR FOUND FLAG	0x0002	2
LOWSIDE OVERCURRENT	0x0004	4
HIGHSIDE OVERCURRENT	0x0008	8
OVER CURRENT READING	0x0010	16
BAD CURRENT OFFSET - Phase A	0x0020	32
BAD CURRENT OFFSET - Phase B	0x0040	64
OPEN WINDING - Phase A	0x0080	128
OPEN WINDING - Phase B	0x0100	256
LOGIC SUPPLY	0x0200	512
GATE SUPPLY	0x0400	1024
BAD FLASH ERASE	0x4000	16384
BAD FLASH SAVE	0x8000	32768

Clear flags by sending “RLF0” to the drive.

<b>G</b>	Current Command (GC)	023	Short	0.01 Amps	Servo drives only
<b>H</b>	Analog Velocity Gain	024	Short	+/- 32767 ADC counts	BLu servo drives only

The “H” register in BLu servo drives is similar to the AG command in all other drives. The “H” register is used to set the motor speed at a given DC voltage in analog velocity mode. It is recommended to make this setting in *Quick Tuner*, where it is labeled Speed in rev/sec at xx Volts, under the Velocity > Analog Operating Mode.

<b>I</b>	Input Counter	025	Long	counts per edge	Q drives only
----------	---------------	-----	------	-----------------	---------------

Host Command Reference

<b>J</b>	Jog Velocity (JS)	026	Short	0.25 rpm	All drives
----------	-------------------	-----	-------	----------	------------

The “J” register units are 0.25 rpm, which means that the value of the “J” register is equal to 240 times the JS command value. In other words, to achieve a jog speed value of 7 rev/sec send the command RLJ1680.

<b>K</b>	RESERVED	027	-	-	-
----------	----------	-----	---	---	---

<b>L</b>	RESERVED	028	-	-	-
----------	----------	-----	---	---	---

<b>M</b>	Max Velocity (VM, servo) Accel/Decel Current (CA, STM Integrated Stepper)	029	Short	Servo: 0.01 amps RMS Stepper: 0.01 amps, peak-of- sine	Servo drives and STM Integrated Steppers
----------	---	-----	-------	--	---

<b>N</b>	Continuous Current (CC, servo) Running Current (CC, stepper)	030	Short	Servo: 0.01 amps RMS Stepper: 0.01 amps, peak-of- sine	All drives
----------	---	-----	-------	--	------------

<b>O</b>	Peak Current (CP, servo) Idle Current (CI, stepper)	031	Short	Servo: 0.01 Amps RMS Stepper: 0.01 amps, peak-of- sine	All drives
----------	--	-----	-------	--	------------

<b>P</b>	Absolute Position Command	032	Long	counts	All drives
----------	---------------------------	-----	------	--------	------------

<b>Q</b>	RESERVED	033	-	-	-
----------	----------	-----	---	---	---

<b>R</b>	Steps per Rev*	034	Short	counts	All drives
----------	----------------	-----	-------	--------	------------

\* Note: R = EG for servo drives. R = EG/2 for stepper drives.

<b>S</b>	Pulse Counter	035	Long	counts	All drives
----------	---------------	-----	------	--------	------------

The “S” register counts pulses coming into the STEP/X1 and DIR/X2 inputs of the drive. This is particularly useful when in Command Mode 7 (see CM command) or executing an FE (Follow Encoder) command. To zero the “S” register send the command RLS0.

<b>T</b>	Total Count	036	Long	(see below)	Q drives only
----------	-------------	-----	------	-------------	---------------

The “T” register is automatically saved at power down and restored at power up.

<b>U</b>	Change Velocity (VC)	037	Short	0.25 rpm	All drives
----------	----------------------	-----	-------	----------	------------

The “U” register units are 0.25 rpm, which means that the value of the “U” register is equal to 240 times the VC command value. In other words, to achieve a change velocity value of 7 rev/sec send the command RLU1680.

<b>V</b>	Velocity (VE)	038	Short	0.25 rpm	All drives
----------	---------------	-----	-------	----------	------------

The “V” register units are 0.25 rpm, which means that the value of the “V” register is equal to 240 times the VE command value. In other words, to achieve a velocity value of 7 rev/sec send the command RLV1680.

<b>W</b>	Time Stamp	039	Short	0.001 sec	Q drives only
----------	------------	-----	-------	-----------	---------------

<b>X</b>	Analog Position Gain (AP)	040	Short	Servo: ADC counts/encoder count Stepper: ADC counts/step	All drives
<b>Y</b>	Analog Threshold (AT)	041	Short	raw ADC counts	All drives
<b>Z</b>	Analog Offset (AV)	042	Short	raw ADC counts	All drives

## User-Defined data registers: 0 - 9, other characters

Ch.	Description	3-digit	Data Type	Units	Compatibility
<b>0</b>	Accumulator	000	Long	integer	Q drives only

The Accumulator register “0” is, aside from being a User-defined data register, the register in which the result of every register math function is placed. For example, if the drive executes the register addition command “R+D1” the result of this operation (i.e. the sum of the values in data registers “D” and “1”) will be placed in the Accumulator “0” register.

<b>1</b>	User-defined	001	Long	integer	Q drives only
<b>2</b>	User-defined	002	Long	integer	Q drives only
<b>3</b>	User-defined	003	Long	integer	Q drives only
<b>4</b>	User-defined	004	Long	integer	Q drives only
<b>5</b>	User-defined	005	Long	integer	Q drives only
<b>6</b>	User-defined	006	Long	integer	Q drives only
<b>7</b>	User-defined	007	Long	integer	Q drives only
<b>8</b>	User-defined	008	Long	integer	Q drives only
<b>9</b>	User-defined	009	Long	integer	Q drives only
<b>:</b>	User-defined	010	Long	integer	Q drives only
<b>;</b>	User-defined	011	Long	integer	Q drives only
<b>&lt;</b>	User-defined	012	Long	integer	Q drives only
<b>=</b>	User-defined	013	Long	integer	Q drives only
<b>&gt;</b>	User-defined	014	Long	integer	Q drives only
<b>?</b>	User-defined	015	Long	integer	Q drives only
<b>@</b>	User-defined	016	Long	integer	Q drives only
<b>[</b>	RESERVED	043	-	-	-
<b>\</b>	RESERVED	044	-	-	-
<b>]</b>	RESERVED	045	-	-	-
<b>^</b>	RESERVED	046	-	-	-
<b>_</b>	RESERVED	047	-	-	-
<b>`</b>	RESERVED	048	-	-	-



# Appendices

The following appendices detail various special topics in working with Applied Motion motor drives.

Appendix A: Non-Volatile Memory in Q drives

Appendix B: Host Serial Communications

Appendix C: Host Serial Connections

Appendix D: The PR Command

Appendix E: Alarm and Status Codes

Appendix F: Working with Inputs and Outputs

Appendix G: eSCL (SCL over Ethernet) Reference

Appendix H: EtherNet/IP Communications

Appendix I: Troubleshooting

Appendix J: List of Supported Drives

Appendix K: SCL Checksum Protocol

Appendix L: <reserved>

Appendix M: Modbus Communication

## Appendix A: Non-Volatile Memory in Q drives

The non-volatile memory in Q drives is partitioned into 16 sections. The partitions are dedicated to various elements of a Q drive's data, and are designated as follows:

Partition 1.....	Q Program Segment 1
Partition 2.....	Segment 2
Partition 3.....	Segment 3
Partition 4.....	Segment 4
Partition 5.....	Segment 5
Partition 6.....	Segment 6
Partition 7.....	Segment 7
Partition 8.....	Segment 8
Partition 9.....	Segment 9
Partition 10.....	Segment 10
Partition 11.....	Segment 11
Partition 12.....	Segment 12
Partition 13.....	Drive Parameters
Partition 14.....	Alarm History
Partition 15.....	NV Data Register Storage Locations 1-100
Partition 16.....	RESERVED

The separation of these partitions is important in understanding how the drive writes to non-volatile memory. For example, each time the SA command is executed by the drive, all of the Drive Parameters are re-written to non-volatile memory partition 13. Similarly, each time an RW command is executed by the drive, all of the one hundred NV Data Register Storage Locations are re-written in partition 15, even if only one of the locations is being updated with a new data register value.

The significance of these operations becomes clear when we consider that the physical non-volatile memory of the Q drive is limited to approximately 10,000 write cycles. This means that after writing to any one of the 16 partitions 10,000 times, the integrity of the data stored in that memory partition cannot be insured.

For this reason, it is not recommended to use the RW or SA commands in stored Q programs. For example, it might be tempting for a user to include an RW command or two in a stored program in such a manner that allows for various data register values to be written to non-volatile memory on a regular basis. The temptation of this is that there won't be a need to reload register values manually in the case of a power down/up cycle: the register values can simply be loaded back into the program (using RR commands) from non-volatile memory. This is to be avoided, though, because using the RW command (or SA command) in this manner could result in the early failure of the non-volatile memory of the drive. The intended use of the RW command therefore is to be used in the early stages of an application, during startup and programming, to set up a series of non-volatile register locations that can be read into a stored program using the RR command.

The partitions designated for Q Program Segment storage are typically not going to be re-written in a manner similar to the RW and SA commands, as they are only accessed during program/segment downloads during startup and programming of an application.

## Appendix B: Host Serial Communications

When a drive is operating in “host mode”, it means that a host device sends commands to the drive (or drives) over a serial connection (or network) and the drive executes the incoming commands. Here are some examples of typical host devices:

- A Windows-based PC running Applied Motion software
- An industrial PC running a custom-built or other proprietary software application
- A PLC with an ASCII module/serial port for sending text strings
- An HMI with a serial connection for sending text strings

The aim of this appendix is to describe the following aspects of operating an Applied Motion Products motor drive in host mode.

- General structure of host serial communications.
- Hardware – wiring and connecting a host device to the serial ports of an Applied Motion drive. (Covered in detail in Appendix C).
- COM Port Settings – UART settings and Bit Rate (Baud) settings.
- Communications Protocol
- Communication Details
- Communication Errors

### General structure of host serial communications

Applied Motion’s host serial communications are based on the common ASCII character set transmitted using standard UARTs over an RS-232 or RS-485 hardware interface.

The ASCII character set is used because it is common and well-understood, as well as easy to read. UART (Universal Asynchronous Receiver Transmitter) serial transceivers are available on many types of equipment, including most PCs, and provide a common form of serial communications interface. RS-232 and RS-485 hardware connections are commonly used with UARTs and also provide the easiest and most common form of connectivity.

### Hardware

Details on drive terminals and connectors for wiring each of the available hardware configurations are shown in Appendix C. Below is an overview of the three available configurations.

**RS-232:** This is the easiest method for drive serial communications. Using an Applied Motion supplied adapter/programming cable (one supplied with each Applied Motion drive) a single drive can be connected directly to any PC with a standard 9-pin RS-232 serial port. Here are some RS-232 highlights:

- Easiest to use
- Configuration of choice for using Applied Motion software applications such as Q Programmer, Quick Tuner and STAC6 Configurator
- Short Cable Lengths
- Serial cable provided with each Applied Motion drive
- Susceptible to EMI

**RS-422 (4-wire RS-485):** RS-422 was originally designed for high reliability communications in point-to-point configurations. It usually requires a special adapter to work with a PC but is common on many types of controllers such as PLCs and HMIs. Our implementation allows for multi-drop communications with a single master (serial network). Here are some RS-422 highlights:

- Relatively easy to use
- NOT supported by Applied Motion software applications such as Quick Tuner or STAC6 Configurator. (Q

Programmer does support RS-422 in a limited fashion).

- Permits longer cable Lengths
- May require special adaptor
- Immune to EMI (when wired properly)

**RS-485 (2-wire RS-485):** Designed for multi-drop serial networks, provides simple wiring, high reliability, and long cable lengths. Here are some RS-485 highlights:

- More difficult to use
- NOT supported by Applied Motion software applications such as Quick Tuner or Configurator. (Q Programmer does support RS-485 in a limited fashion).
- Permits longest cable lengths: up to 1000 feet at low baud rates
- May require special adaptor
- Fewest wires, smaller cables
- Immune to EMI (when wired properly)

## COM Port Settings

**UART Settings:** We operate our UARTs with the following settings: 1 start bit, 8 data bits, 0 (no) parity bits, and 1 stop bit.

**Bit rate (baud) Settings: (BR and PB commands):** All AMP drives default to 9600 baud from the factory. In most cases this speed is adequate for setup, configuring, programming, as well as host mode communications. If higher baud rates are required the drives can be configured to operate with a different rate using the BR (Bit rate) or PB (Power-up Bit rate) command. In all cases the drive starts up at the factory rate, 9600, and will remain there if the “power-up packet” is acknowledged by the host (see “Drive Startup” below). When the power-up cycle is complete and if the drive has not received the power-up packet, the drive will activate the new baud rate.

Selecting a baud rate higher than the default 9600 is dependent on the application. If there is a host device operating a number of drives on a network, a higher speed may be required in order to process all the communication needs.

## Communications Protocol

In general, the protocol for communications between a host device and a drive is quite simple. The drives do not initiate communications on their own, so drives are normally in a state to receive packets from the host. A communications packet, or packet for short, includes all the characters required to complete a command (host to drive) or response (drive to host) transmission. In other words, a host initiates communication by sending a command packet, and the drive responds to that command (if necessary) by sending a response packet back to the host.

**Command Transmission (host to drive):** The transmission of characters to the drive requires the host to send all the required characters that form a packet in a limited time frame. At the start of receiving a packet, the drive begins timing the space between characters. Each time a character is received an internal timer is reset to 200 milliseconds. If the timer reaches zero before the next character in the packet is received the drive will terminate its packet parsing (characters will still go into the receive buffer) and may send out an error response packet depending on the protocol setting. The purpose of the time-out feature is to allow the drive to purge its buffers automatically when a bad transmission occurs.

*NOTE: This time-out feature limits the usage of host devices such as the Windows application HyperTerminal. We recommend using Applied Motion’s SCL Setup Utility instead. This utility sends out an entire command packet with the minimum delay between characters, and includes the packet’s terminating character (carriage return).*

Command packets are terminated by a Carriage Return (ASCII 13).

**Response Transmission (drive to host):** In response to a command packet from the host a drive can send a response packet. The drive sends out its entire response packet with very limited space between characters.

At 9600 baud the space between characters is less than 1 bit space (0.0001 seconds). The host system must be able to handle this speed. The space between characters can vary depending on the settings of the PR command (see below).

Response packets are terminated by a Carriage Return (ASCII 13).

**Protocol Settings (PR Command):** The PR (Protocol) command offers users the ability to add various features to the overall communications protocol, i.e. tailor the structure of command and response packets to best fit the needs of the application. In general, when a host device sends a command packet to a drive, the drive will either understand the command or not. If the drive understands the command the drive executes the command. If the drive doesn't understand the command it cannot execute the command. In most cases the host device will want to know whether the drive has understood the command or not, and so the drive can be set to automatically send an Acknowledge (understood) or Negative Acknowledge (not understand) response packet to the host for every command packet received.

Along with Acknowledge/Negative Acknowledge (Ack/Nack), the PR command controls a number of other protocol settings. See Appendix D for details on the PR command. Also, the PR command controls whether or not the drive will respond with error codes in the response packet when communications errors occur.

## Communication Details

**Transmit Delay: (TD Command):** The TD command allows users to define a dwell time in a drive, which is used by the drive to delay the start of transmission of a response packet after the end of reception of a command packet.

When using 2-wire RS-485 networks there are times when a drive's response packet must be delayed until the network is ready for the drive to transmit. Why is this necessary? The answer is because RS-485 networks are by nature "half-duplex", which means you cannot transmit and receive at the same time. Rather, a host must first transmit, stop, then wait to receive. This is because the host and drive transmitters share the same pair of wires. When transmitting, the device that has the transmission rights must assert its transmitter outputs and therefore take control of the pair. At the same time all other devices on the network must de-assert, or open, their transmitters so as not to interfere with the device that has the rights. Transmitters in this scenario have tri-state outputs: the three states are transmit, open, and receive.

Some devices are not as quick in opening their transmitters as others. For this reason it may be necessary for other, faster devices on the network to dwell some time while the slower devices open their transmitters. Applied Motion drives de-assert their transmitters very quickly. Typically it is done within 100 microseconds (.0001 second) after the end of a packet transmission. However it is possible that the host device won't be this fast, and so the TD command allows users to set the time delay that an Applied Motion drive will delay after receiving a command packet before sending a response packet.

**Communications Packet:** A Communications Packet, or **packet** for short, includes all the characters required to complete a command or response transmission. This can vary depending on the settings of the PR command. See Appendix D for more on the PR command. All packets are terminated by a Carriage Return (ASCII 13).

**Drive Startup:** At power-up, all Applied Motion drives send out what is called the "power-up packet". This packet notifies a host of the drive's presence. After sending the power-up packet the drive waits for a response from the host. This is one of the rare instances in which a drive will initiate communications with the host. This process is necessary for a number of Applied Motion software applications such as Quick Tuner and STAC6 Configurator. The power-up packet is an exception to the ASCII character rule in that all the characters in the packet are binary value. Even if the character is printable its binary value is what is important. The power-up packet consists of three binary characters with the first character being a binary 255 (255 is not a printable ASCII character). This character designates to the software application that the packet is a power-up packet. The following two characters are the firmware version number and the model number of the drive, respectively.

Power-Up Packet = (255)(F/W Version)(Model No.)

As an example, a BLuAC5-Si with f/w version 1.53 firmware will send out a power-up packet that looks like this: (255)(53)(38). To an ASCII terminal this packet may look like "ÿ5&". The (255) is the power-up packet designator, the (53) actually stands for f/w version 1.53 (the "1" is implied), and the (38) is an internal model

number for the “BLuAC5-Si”

The power-up packet is always sent at 9600 baud, regardless of the bit rate set by the BR or PB command. If an Applied Motion software application is present it will respond to the power-up packet and communications will continue at 9600 baud. If an Applied Motion software application is not present, the drive's request made by the power-up packet will time-out and the drive will begin communicating at the saved bit rate (BR or PB command), 9600 or otherwise.

**Interaction with PM parameter (Power-up Mode):** If the drive is currently in power-up modes 1 or 3 (PM1 or PM3), it will be unable to respond to standard SCL commands. In these modes the drive is using a proprietary communication protocol used by Si Programmer (and its interface to the SiNet Hub units) as well as the QuickTuner and Configurator software programs. Standard SCL commands will not be recognized or acted upon by the drive in these modes. If the application requires it, the drive may be temporarily forced into SCL mode through the use of the “double zero.”

**Double Zero:** When the drive initializes, it will send the power-up packet as detailed above. Typically this packet is used only by Applied Motion Products software, but a host device may also use it to force SCL communication in a drive otherwise not configured to do so.

The host device must recognize the power-up packet and respond with a simple double zero (00). No carriage return is required. Note that this response must occur within 2 seconds of the power-up packet being sent, but must delay at least 2 milliseconds (0.002 sec). This will force the drive into standard SCL mode and enable serial communication without altering the PM setting of the drive.

## Communication Errors

During the process of sending communication packets between the host and drive(s), two different types of communication errors can occur.

**Hardware errors:** Hardware errors are displayed physically by a drive (via either LEDs or a 7-segment display on the drive, see Appendix F), but no response packet is automatically generated from the drive to the host. Therefore it is the responsibility of the host to check for hardware comm errors using the AL, RS, and/or SC commands. See Appendix F for more details on the AL and SC commands. Once the host has determined the presence of a hardware comm error, the nature of the error can be retrieved using the CE command.

**Parsing errors:** Parsing errors happen when a drive receives a command packet but cannot properly interpret (parse) the command. Parsing errors can automatically generate a response packet from the drive to the host, depending on the settings of the PR command (see Appendix D, PR command, Bit 2).

# Appendix C: Host Serial Connections

## Introduction

When communicating to a drive over its serial port you will always be using one of the following serial connections: RS-232, 2-wire RS-485, or 4-wire RS-485. Out of the box we suggest starting with RS-232 along with the programming cable and software that was supplied with your Q drive, so that you may be communicating to and familiarizing yourself with your drive as quickly as possible. All software from Applied Motion communicate to a drive via the supplied RS-232 programming cable. These software include:

Quick Tuner -----used for tuning and configuring servo drives  
 Configurator-----used for configuring your stepper drives  
 Q Programmer -----create and edit stored Q programs, emulate a host  
 SCL Setup Utility -----basic host terminal for host emulation

If your project calls for a Q drive (or drives) running stored programs, you will use the supplied RS-232 programming cable along with Quick Tuner or Configurator and Q Programmer to setup, configure, and program your drive(s). If your project calls for your drive(s) only running stored programs, you can read up on the RS-232 sub-section in this section and not read any more about the other serial connections. However, if your application calls for a serial host controller (PC, PLC, HMI, or other serial device that can act as a host) being able to communicate to the drive(s), you will need to choose one of the three available serial connections.

## Available Host Serial Connections: RS-232, 2-wire RS-485, 4-wire RS-485

When choosing the best serial connection for your project, the choice may be made for you based on the host controller you plan to use. For example, some devices only communicate via 2-wire RS-485. If you are not restricted by your host controller, here are two guidelines for choosing the best connection.

### Single or multi-axis

If your project calls for communicating to only one drive you can consider any of the three options. If your project calls for communicating to more than one drive you should use 2-wire or 4-wire RS-485.

### Long communication cables

In many applications, the limitation of 50 feet on RS-232 will be sufficient. In applications where the distance between drive and host controller will be more than 50 feet (up to 1000 feet), you will need to choose 2-wire or 4-wire RS-485.

## A Quick Summary of 2-wire and 4-wire RS-485 connections

The 2-wire and 4-wire RS-485 protocols that the drives utilize are based on industry standard RS-485 and RS-422 protocols. Strictly defined, RS-485 is a 2-wire interface that allows multi-node connections limited to half-duplex serial communications. Up to 32 nodes that both transmit and receive can be connected to one network. On the other hand, RS-422 in the strictest definition is a 4-wire point-to-point connection that allows full-duplex serial communications when connected to a single node. RS-422 has one node that is the driver or transmitter and up to 10 nodes that are receivers. RS-422 was not designed for a true multi-node network.

2-wire interfaces require one more significant feature. A network node, master or slave, must be able to tri-state its transmitter to allow other nodes to use the network when required. For high speed baud rates this must be done very quickly to avoid communication collisions.

4-wire interfaces can go beyond simple point-to-point communications and be used in multi-node networks if the slave nodes are capable of tri-stating their transmitters as required in the 2-wire networks. Some RS-485 devices (like Applied Motion drives) are set up to do this and can be used in a 4-wire, multi-node configuration.

The drives are designed to work in a multi-node environment, and so they use both the standard 2-wire RS-485 connection, and a modified RS-422 (4-wire) connection that has been termed "4-wire RS-485". This is because unlike the standard RS-422, which is designed for single-node connections, the 4-wire RS-485 used by

Applied Motion drives allows multiple nodes.

NOTE: In general we recommend using half-duplex communications with the drives. Even though the 4-wire RS-485 network can support full-duplex, there is now the capability to have multiple nodes and therefore data collisions might occur. For this reason we recommend limiting communications to half-duplex, even with the 4-wire RS-485 connections.

## Connecting to your Q drive's serial port(s)

Each drive comes with one or two physical connectors for connecting to a PC or other serial host controller device. One connector is an RJ11 connector (same as a 4-wire phone jack) that is used strictly for RS-232 communications. The second connector is a removable 5-position terminal block for use with 2-wire and 4-wire RS-485 connections.

## COM Port Settings

When using software from Applied Motion Products to communicate to a drive there is no need to worry about COM port settings because the software will take care of them. In applications where a host serial controller will be communicating to a drive via one of its serial ports, the COM port settings should be set as follows: 8 data bits, no Parity, 1 stop bit. The default Baud rate is 9600, though this can be changed (see BR and PB commands).

## Connecting to a PC using RS-232

Each drive comes with a programming cable for use with the drive's RS-232 port. This cable is made up of two parts, a 7 foot 4-wire cable (looks just like a 7 foot telephone cord), and an RJ11 to 9-pin DSUB adapter. This adapter allows you to connect to the COM port (serial port) of your PC. Here are the general directions for connecting your drive to your computer.

- Locate your computer within 6 feet of the drive.
- Plug the 9-pin end of the adapter supplied with your drive to the COM1 serial port of your PC. Secure the adapter with adapter's two screws. If the COM1 port on your PC is already used by something else, you may use the COM2 port of your PC. On some PCs, COM2 will have a 25-pin connector rather than a 9-pin. If this is the case with your PC, and you must use COM2, you will have to purchase a 25 to 9 pin serial adapter at your local computer store.

*NOTE: If you are using a laptop computer that does not have any COM ports, you will have to use either a USB to Serial adapter or a PCMCIA Serial adapter. There are a variety on the market, and some work better than others. But in general, once you've installed one of the adapters your PC will assign the adapter a COM port number. Remember this number when you go to use your Applied Motion software. Also, if you are having troubles with your adapter, contact Applied Motion for help with recommended adapters.*

- Now take the 7 foot cable and plug one end into the adapter you just attached to your PC's COM port, and plug the other end into the RS-232 (RJ11) jack on the drive. If you need to locate your drive farther from the PC, you can replace the 7 foot cable with any 4-wire telephone cord. Do not exceed 50 feet.

**WARNING:** Never connect an Applied Motion Products drive to a telephone circuit. It uses the same connectors and cords as telephones and modems, but the voltages are not compatible.

## Connecting to a host using 4-wire RS-485

An Applied Motion drive's 4-wire RS-485 implementation is a multi-drop network with separate transmit and receive wires. One pair of wires connects the host's TX+ and TX- signals to each drive's RX+ and RX- terminals. Another pair connects the RX+ and RX- signals of the host to the TX+ and TX- terminals of each drive. A common ground terminal is provided on each drive and can be used to keep all drives at the same ground potential. This terminal connects internally to a drive's ground connection, so if all the drives on the 4-wire network are powered from the same supply it is not necessary to connect the logic grounds. You should still connect one drive's GND terminal to the host's signal ground. Before wiring the entire system you'll need to connect each drive individually to the host so that a unique address can be assigned to each drive. (See following sub-section "Before you connect the drive to your system"). Proceed as follows, using the figure below.



1. Connect the drive TX+ to the host RX+.
2. Connect the drive TX- to the host RX-.
3. Connect the drive RX+ to the host TX+.
4. Connect the drive RX- to the host TX-.
5. Connect GND to the host signal ground.
6. We recommend a 120 ohm terminating resistor be connected between the Rx+ and Rx- terminals of the drive farthest from the host.

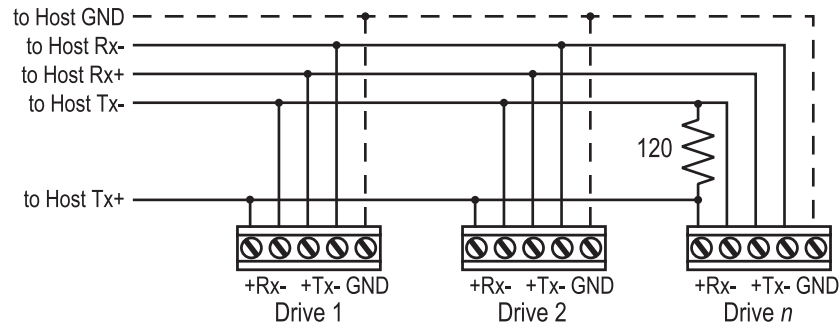

**NOTE:** Proper cable shielding is a must. High voltage, high frequency, high current signals that are present on the servo motor cables can emit a significant amount of electrical interference. Without proper shielding on the communications wiring this interference can disrupt even noise-tolerant differential line drivers.

## Getting and Connecting an RS-485 4-wire adapter to your PC.

If you are using your computer to communicate to the drive(s) and therefore need an RS-485 adapter, model 117701 from Jameco Electronics (800-831-4242) works well. This adaptor is for a 25-pin serial port. If you are like most people and have a 9-pin serial port on your PC, you will also need to purchase Jameco cable 31721. Connect as follows:

Adaptor Terminal	Drive Terminal
1	RX+
2	RX-
3	TX-
4	TX+

Set the switches on the Jameco adaptor for DCE and TxON, RxON. Don't forget to plug in the DC power adaptor that comes with the unit.

## Connecting to a host using 2-wire RS-485

An Applied Motion drive's 2-wire RS-485 implementation is a multi-drop network with one pair of wires that is used for both transmit and receive. To make this type of connection you will first need to jumper the TX+ terminal of a drive to its own RX+ terminal, and then do the same with the TX- and RX- terminals. To then connect a drive to the host, you will need to connect the TX+/RX+ terminals of the drive to the host's TX+/RX+ terminal, and then the TX-/RX- terminals of the drive to the host's TX-/RX- terminal. We also recommend a 120 terminating resistor be connected between the Tx+ and Tx- terminals of the drive farthest from the host. Here is a diagram.

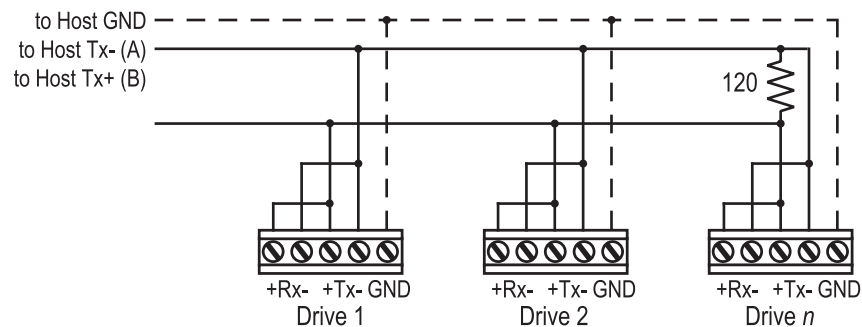

## Getting and Connecting an RS-485 2-wire adapter to your PC.

If you are using your computer to communicate to the drive(s) and therefore need an RS-485 adaptor, model 485-25E from Integrity Instruments (800-450-2001) works well. It comes with everything you need. Connect as follows:

Adaptor Terminal	Drive Terminals
A	TX+/RX+
B	TX-/RX-

### Before you connect the drive to your system

If you plan to implement a 2-wire or 4-wire RS-485 network of drives, you will first need to address each drive individually. An easy way to do this is prior to hooking the drives up with one of the RS-485 implementations shown above, use the RS-232 cable that came with each drive and the SCL Setup Utility. If you've already connected your drive using one of the RS-485 implementations, completing this sub-section will allow you to test your connections.

First connect your PC and drive. (See preceding sub-sections on connecting to a PC or host for help with this). Then launch the *SCL Setup Utility* on your PC. If you don't have the *SCL Setup Utility* installed, you can get it either from the CD-ROM that came with your drive or from Applied Motion's web site, [www.applied-motion.com/support/software.php](http://www.applied-motion.com/support/software.php).

Once the *SCL Setup Utility* is launched, select the proper COM port of your PC, and then apply power to the drive. Press the Caps Lock key on your keyboard (because the drives only accept commands in uppercase). Type RV then press Enter. If the drive has power and is properly wired, it will respond with "RV=x", where x is the firmware version of your drive. This confirms that communication has been established. If you don't see the "RV=x" response, check your wiring and follow the above procedures again.

Next, you must choose an address for each drive. Any of the "low ascii" characters (many of which appear above the number keys on a PC keyboard) are acceptable:

! " # \$ % & ' ( ) \* + , - . / 0 1 2 3 4 5 6 7 8 9 ; : < > ? @

To find out which address is already in your drive, type DA then press Enter. The drive will respond with "DA=x", where x is the address that was last stored. To change the address, type "DAy", where y is the new address character, then press Enter.

To test the new address, type "yRV" where y is the address you've just assigned to the drive, and then press Enter. For example, if you set the address to % and want to test the address, type "%RV" then press Enter. The drive should respond with "%RV=x" where x is the firmware version of the drive.

Once each drive in your network has been given a unique address, you can proceed with wiring the whole network together.

## Appendix D: The PR Command

Because of the intense nature of serial communications required in host mode applications, you are allowed to adjust a drive's serial communications protocol to best fit your application. This adjusting of a drive's serial communications protocol is done using the PR command.

Typically the PR command is used one time when configuring a drive and saved as part of the startup parameters (use SA command to save startup parameters). However, it can be changed at any time to dynamically alter the serial communications.

The PR command works by sending the decimal equivalent of a 9-bit binary "word". Each bit in the word represents a different setting of the serial communications protocol. These settings are additive, meaning when you set a bit to "1", or turn it on, you are adding the functionality of that setting to the serial protocol. Think of this 9-bit word as a bank of 9 dip switches. You can turn each dip switch on or off, and in doing so add or subtract a particular setting from the overall protocol.

### The PR command in detail

The diagram to the right shows the assignments of each of the 9 bits in the protocol word. Remember that when you use the PR command the parameter that you send along with the command code (PR) is the decimal equivalent of this binary word. Below are the details of each of the bits and the settings they are assigned to.

#### Bit 0 - Default ("Standard SCL")

PR cannot be set to 0, so if no other bits in the PR word are set to 1 then at least bit 0 must be set to 1. Setting Bit 0 to 1 when any other bits are also set to 1 has no effect on the communications protocol. For example, PR4 (bit 2 set to 1) is the same as PR5 (bits 0 and 2 set to one). With only bit 0 set to 1, when commands that do not request returned data are received by the drive no other response is sent from the drive. In other words, the drive will only send a response to commands that require a response.

Send data Examples:

Command	Drive Sends	Notes
DI8000	-	Global set distance to 8000 counts or steps
1DI8000	-	Drive with address "1" set distance to 8000 counts or steps

Request data Examples:

Command	Drive Sends	Notes
DI	DI=8000	Global distance request
1DI	1DI=8000	Drive with address "1" responds with distance

#### Bit 1 - Address Character (always send address character)

With this option set (Bit 1=1) a drive's address character will always be included in the response packet along with any requested data.

Send data Examples:

Command	Drive Sends	Notes
VE50	-	Global set velocity to 50 rps
1VE50	-	Drive with address "1" set velocity to 50 rps

Request data Examples:

Command	Drive Sends	Notes
VE	1VE=50	Drive responds with address "1" and velocity to global velocity request
1VE	1VE=50	Drive responds with address "1" and velocity to specific velocity request from drive at address "1"

## Bit 2 - Ack/Nack (always send acknowledge character)

This option causes the drive to acknowledge every transmission from a host, whether the command is requesting data or not. If a host requests data (for example a DI command with no parameter), the response is considered the acknowledgement. However, if the host sends commands that do not request data from the drive, the drive will still respond with one of the following characters:

"%" - The "percent" character is a Normal Acknowledge (Ack) character that means the drive accepted the command and executed it.

"\*" - The "asterisk" character is an Exception Acknowledge (Ack) character that means the drive accepted the command and buffered it into the queue. Depending on the status of the queue, execution of the exception acknowledged command(s) can occur at any time after the acknowledge.

"?" - The "question mark" character is a Negative Acknowledge (Nack) character that means a parsing error occurred while the drive was receiving the command. A second character may follow the question mark, which provides an error code describing the type of parsing error. Here is the list of error codes:

Negative Acknowledge Codes

- 1 Command timed out
- 2 Parameter is too long
- 3 Too few parameters
- 4 Too many parameters
- 5 Parameter out of range
- 6 Command buffer (queue) full
- 7 Cannot process command
- 8 Program running
- 9 Bad password
- 10 Comm port error
- 11 Bad character
- 12 I/O point already used by current Command Mode, and cannot be changed (Flex I/O drives only)
- 13 I/O point configured for incorrect use (i.e., input vs. output) (Flex I/O drives only)
- 14 I/O point cannot be used for requested function - see HW manual for possible I/O function assignments. (Flex I/O drives only)

Acknowledge characters are always sent out of the RS-232 port. When operating on a 2-wire or 4-wire RS-485 network, the acknowledge characters are sent out under the following conditions:

1. An acknowledge character is sent when the received command has an address character at the beginning.
2. An acknowledge character is NOT sent when global commands (commands without addresses) that do not request data from the drive are used.
3. Global commands that request data will cause data to be returned from the drive(s). This can cause data collisions if there are more than one drive on a network. NOTE: Always use addresses with commands in multi-drop networks to avoid data collisions.

**NOTE:** When possible avoid using Acknowledge characters (% , \* , ?) as drive addresses in multi-drop networks to prevent confusion.

Good command Example:

Command	Drive Sends	Notes
DI8000	%	Drive sends normal Ack (over RS-232 port only) in response to global set distance to 8000
1DI8000	1%	Drive at address "1" sends normal Ack (over both ports) in response to address-specific set distance to 8000

Bad command Example:

Command	Drive Sends	Notes
VE200	?5	Drive sends Nack (over RS-232 port only) in response to global set velocity to 200 rps; error code 5 is sent because parameter "200" is out of range
1VE200	1?5	Drive at address "1" sends Nack (over both ports) and error code in response to address-specific set velocity to 200 rps

Buffered command Example:

Command	Drive Sends	Notes
AC10	*	Drive sends Exception Ack (over RS-232 port only) in response to global set acceleration to 10 rps/s
1AC10	1*	Drive at address "1" sends Exception Ack and address (over both ports) in response to address-specific set acceleration

### Bit 3 - Checksum

When this bit is 1, checksum is implemented. When this bit is 0, checksum is not implemented.

### Bit 4 - RS-485 Adapter mode

Allows using a drive as an RS-232 to RS-485 adapter by letting the host communicate on an RS-485 network through the first drive's RS-232 port. When the host sends commands with a "~" (tilde) at the beginning of the command to the first drive's RS-232 port, the command is echoed out of both of that drive's RS-232 and RS-485 ports. Drives connected on the RS-485 network will receive the same command with the "~" stripped off.

Without the Bit 4 option (Bit 4=0), a drive will normally echo any addressed command out of the RS-232 port only, whether the command was received from the drive's RS-232 or RS-485 port. What the Bit 4 setting does (Bit 4=1), is force the drive to echo commands out the RS-485 port as well, allowing a host that is connected to a drive through its RS-232 port, to communicate to an RS-485 network of drives.

**NOTE:** When both Bits 4 and 2 are set (Bit 4=1, Bit 2=1), the host will receive back both the echoed packet and the acknowledge packet. For example, two drives are connected in an RS-485 network, and they both have PR command Bits 4 and 2 set. The first drive, which is also connected to the host via its RS-232 port, is addressed "1", and the second drive is addressed "2". Here is what you will see:

Send data Example:

Command	Drive Sends	Notes
~2DI8000	2DI8000	Drive at address "1" echoes original command over both serial ports
	2%	Drive at address "2" responds with ack.

Request data Example:

Command	Drive Sends	Notes
~2DI	2DI	Drive at address "1" echoes original command over both serial ports
	2DI8000	Drive at address "2" responds with distance

## Bit 5 - 3-digit numeric register addressing

Each data register in a drive is normally accessed using its single letter, number, or other ascii character. With Bit 5 set (Bit 5=1), each of the data registers is instead accessed with a 3-digit number: 000 to 074. (See the Data Registers section for character and 3-digit numerical assignments). The Bit 5 option implements this specific usage for the RL (Register Load) and RU (Register Upload) commands.

*NOTE: When data is returned from a drive (whether Bit 5 is set or not set), the data register is always represented by its single character designation.*

RL Command Example:

Command	Drive Sends	Notes
RL017100	-	Load register 017 ("A") with the value 100
RL017	RLA=100	Drive sends contents of acceleration register

RU command Example:

Command	Drive Sends	Notes
RU0174	RUA=100 RUB=150 RUC=140 RUD=210	Drive responds to register upload command by sending contents of 4 sequential data registers, starting with register 017 ("A")

Note: 3-digit numeric register addressing may be required for some 3rd party PLCs, HMIs, etc.

## Bit 6 - Checksum Type

When this bit is 1, STM type checksum is implemented. When this bit is 0, SSM type checksum is implemented.

## SSM type Checksum Protocol

Step-Servo (SSM/TSM/TXM/SS) and SV200 drives support “SSM type” checksum protocol. When bit 3 in PR command is set to 1 and bit 6 in PR is set to 0, for example PR=13, then “SSM type” checksum protocol is implemented.

Step-Servo (SSM/TSM/TXM/SS) and SV200 drives can also support “STM type” checksum protocol. When both bit 3 and bit 6 in PR command are set to 1, for example PR=77, then “STM type” checksum protocol is implemented.

ST/STM/SWM drives do not support “SSM type” checksum protocol.

### SSM type Checksum protocol and Data Frame

This Checksum Protocol is based on 1’s complement, and added at the end of every “Command”. There is a delimiter “{” between the “Command” chars and the one byte Checksum. The Data Frame as the following:

**Example:** “CC” Command

Send Command (from Host):

Host Request: CC{79

Chars	“C”	“C”	“{”	CHKsm: 0x79 (2 ASCII )		“Carriage Return”
Hex	0x43	0x43	0x7B	0x37	0x39	0x0D

Receive back (from Drive):

Drive Response: CC=5{07

Chars	“C”	“C”	“=”	“5”	“{”	CHKsm: 7 (2 ASCII)		“Carriage Return”
Hex	0x43	0x43	0x3D	0x35	0x7B	0x30	0x37	0x0D

If you get a Nack response “?10”, this is a comm port error that may be a bad checksum. To see what it is use the “CE” command which will give back an error code in “Hex”.

Here is the list of Error codes for the “CE” command (the ones in BLUE are for the checksum)

Command	Hex Code	Dec Code	Description
CE	0x0000	0	Communication is normal
	0x0001	1	Communication Parity bit does not match
	0x0002	2	Communication Framing Error
	0x0004	4	noise on the receiver input
	0x0008	8	Overflow error
	0x0010	16	Receive Buffer is Full
	0x0020	32	Transmit Buffer is Full
	0x0040	64	Bad SPI opcode (this only for SPI interface comm)
	0x0080	128	Transmit Time Out
	0x0100	256	Receive Time Out
	0x0200	512	Bad checksum on the receiver
	0x0400	1024	Too many chars for the command

### How to using the checksum feature

The checksum is a option feature for all drives. To use this feature, please set the bit3 in PR command.

Example: For Ack (select by Bit2 of PR command) and checksum, set PR13 (Note: the Bit0 should be always set). If you want to know the detail of this command, please refer to the document “Host Command Reference”.

Here is the format of the protocol: [optional] (delimiters)

**[Address] Command Parameter(s) (“{”, ASCII 123) Checksum (“Carriage Return”, ASCII 13)**

- The character “{”, ASCII 123, is used to delimit the main packet and the checksum.
- The checksum value is 8-bit, 1’s complement (add up all the character from the “Address” to “Parameter” don’t include the “{” character, “mask” off the lower byte (means grabbing the lower byte of the checksum) to restrict it to 8 bits, invert all the bits), and then convert the value to ASCII chars.

*NOTE 1: There is no checksum on the “Ack” or “Nack” packets. These are very simple responses that in the case of an “Ack” does not have data or the “Nack” has only an error code.*

*NOTE 2: when checksumming is turned on, you are **NOT** allowed to send a packet without the checksum, otherwise it will return back “?12”(means no Checksum), In the other hand, when checksumming is turned off, but send command with checksum, it will return a “?4”(means too many parameters).*



## STM type Checksum Protocol

ST/STM/SWM drives support “STM type” checksum protocol. When bit 3 in PR command is set to 1, for example PR=13, then “STM type” checksum protocol is implemented.

Step-Servo (SSM/TSM/TXM/SS) and SV200 drives also support “STM type” checksum protocol. When both bit 3 and bit 6 in PR command are set to 1, for example PR=77, then “STM type” checksum protocol is implemented.

Step-Servo (SSM/TSM/TXM/SS) and SV200 drives can also support “SSM type” checksum protocol. When bit 3 in PR command is set to 1 and bit 6 in PR is set to 0, for example PR=13, then “SSM type” checksum protocol is implemented.

### STM type Checksum protocol and Data Frame

This Checksum Protocol is based on 1’s complement, and added at the end of every “Command”. There is a delimiter “{” between the “Command” chars and the one byte Checksum. The Data Frame as the following:

**Example:** “CC” Command

Send Command (from Host):

Host Request: CC

Chars	“C”	“C”	“{”	CHKsm	“Carriage Return”
Hex	0x43	0x43	0x7B	0x79	0x0D

Receive back (from Drive):

Drive Response: CC=1.2

Chars	“C”	“C”	“=”	“1”	“.”	“2”	“{”	CHKsm	“Carriage Return”
Hex	0x43	0x43	0x3D	0x31	0x2E	0x32	0x7B	0xAB	0x0D

If you get a Nack response “?10”, this is a comm port error that may be a bad checksum. To see what it is use the “CE” command which will give back an error code in “Hex”.

Here is the list of Error codes for the “CE” command (the ones in BLUE are for the checksum)

Command	Hex Code	Dec Code	Description
CE	0x0000	0	Communication is normal
	0x0001	1	Communication Parity bit does not match
	0x0002	2	Communication Framing Error
	0x0004	4	noise on the receiver input
	0x0008	8	Overflow error
	0x0010	16	Receive Buffer is Full
	0x0020	32	Transmit Buffer is Full
	0x0040	64	Bad SPI opcode (this only for SPI interface comm)
	0x0080	128	Transmit Time Out
	0x0100	256	Receive Time Out
	0x0200	512	Bad checksum on the receiver
	0x0400	1024	Too many chars for the command

### How to using the checksum feature

The checksum is a option feature for all drives. To use this feature, please set the bit3 in PR command.

Example: For Ack (select by Bit2 of PR command) and checksum, set PR13 (Note: the Bit0 should be always set). If you want to know the detail of this command, please refer to the document “Host Command Reference”.

Here is the format of the protocol: [optional] (delimiters)

**[Address] Command Parameter(s)** (“{”, ASCII 123) **Checksum** (“Carriage Return”, ASCII 13)

- The character “{”, ASCII 123, is used to delimit the main packet and the checksum.
- The checksum value is 8-bit, 1’s complement (add up all the character from the “Address” to “Parameter” don’t include the “{” character, “mask” off the lower byte (means grabbing the lower byte of the checksum) to restrict it to 8 bits, invert all the bits), and then convert the value to ASCII chars.

*NOTE 1: There is no checksum on the “Ack” or “Nack” packets. These are very simple responses that in the case of an “Ack” does not have data or the “Nack” has only an error code.*

*NOTE 2: when checksumming is turned on, you are **NOT** allowed to send a packet without the checksum, otherwise it will return back “?12”(means no Checksum), In the other hand, when checksumming is turned off, but send command with checksum, it will return a “?4”(means too many parameters).*

## Bit 7 - Little/Big Endian in Modbus Mode

When this bit is 1, Little Endian is used. When this bit is 0, Big Endian is used.

## Bit 8 - Full Duplex in RS-422

When this bit is 1, Full Duplex is used. When this bit is 0, Half Duplex is used.

## PR Command Examples

Now that you know what the bits in the PR command's 9-bit binary word mean, here are a couple examples showing how you would set the serial communications protocol of your drive.

Example: Turn on Ack/Nack (Bit 2) and 3-digit numeric register addressing function (Bit 5)

The 9-bit word for this combination is - 000100100 - and it's decimal equivalent is 36. Therefore, to set your drive with this serial protocol, you would send the command "PR36" to your drive.

Example: Turn on RS-485 adaptor function (Bit 4)

The 9-bit word for this combination is - 000010000 - and it's decimal equivalent is 16. Therefore, to set your drive with this serial protocol, you would send the command "PR16" to your drive.

## Appendix E: Alarm and Status Codes

One of a drive's diagnostic tools is its ability to send alarm and status codes back to a host. The AL (Alarm code) and SC (Status Code) commands can be used by a host to query a drive at any time. If a drive faults or sets an alarm, the AL command allows the host to find out what alarm, or alarms, has been set. Similarly, the SC command allows a host to find out what the status code of a drive is at any time during drive operation. A status code provides information as to whether the drive is running, in position, disabled, homing, and other conditions. Both alarm and status codes can be very useful when initially setting up and integrating a servo system into your machine.

The Alarm and Status codes are hexadecimal equivalents of 16 bit binary "words". Each bit in each binary word is assigned a meaning, and therefore a code word can actually show information about more than one alarm or status condition.

### Alarm Code Definitions

#### AL command

When a host sends the AL command, the response from the drive will be the Hexadecimal equivalent of a 16-bit word. This hexadecimal value is considered the Alarm Code, and the hexadecimal value for each of the bits in the Alarm Code is given below.

Hex Value	BLu	SV	STAC6	ST	STM
0001	<b>Position Limit</b>				
0002	CCW Limit				
0004	CW Limit				
0008	<b>Over Temp</b>				
0010	<b>Excess Regen*</b>	<b>Internal Voltage</b>	<b>Excess Regen</b>	<b>Internal Voltage</b>	<b>Internal Voltage</b>
0020	<b>Over Voltage</b>				
0040	<b>Under Voltage*</b>	Under Voltage	<b>Under Voltage</b>	Under Voltage	Under Voltage
0080	<b>Over Current</b>				
0100	<b>Bad Hall Sensor</b>		<b>Open Motor Winding</b>		
0200	<b>Bad Encoder</b>				(not used)
0400	Comm Error				
0800	Bad Flash				
1000	Wizard Failed		No Move		
2000	Current Foldback		Motor Resistance Out of Range	(not used)	(not used)
4000	Blank Q Segment				
8000	No Move		(not used)		

\* BLuAC drives only

NOTE: Items in **bold italic** represent Drive Faults, which automatically disable the motor. Use the OF command in a Q Program to branch on a Drive Fault.

Example: The drive has hit the CW limit (0004), there is an under voltage condition (0040), and an encoder wiring connection has been lost resulting in an encoder fault (0200). The resulting Alarm Code is 0244, and when the host sends the "AL" command the drive will respond with "AL=244".

#### "f" data register

Another way to retrieve the Alarm Code is to use the "f" data register. If the host sends the RLf command, the response from the drive will be the decimal equivalent of the 16-bit Alarm Code word. The diagram below

shows the 16 bit assignments for the Alarm Code (which of course match the hexadecimal values above).

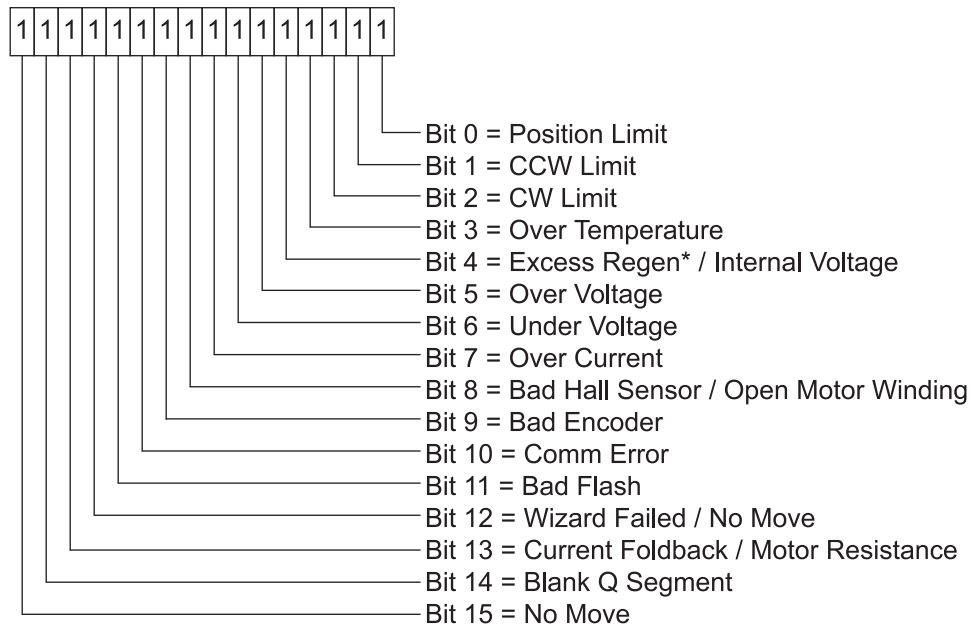

### Alarm Code 16-bit word

Example: The drive has hit the CW limit (bit 2), there is an under voltage condition (bit 6), and an encoder wiring connection has been lost resulting in an encoder fault (bit 9). The resulting Alarm Code binary word is 0000 0010 0100 0100. The decimal equivalent of this word is 580, so the response from the drive to the RLf command will be "RLf=580".

## Status Code Definitions

### SC command

When a host sends the SC command, the response from the drive will be the Hexadecimal equivalent of a 16-bit word. This hexadecimal value is considered the Status Code, and the hexadecimal value for each of the bits in the Status Code is given below. When a host sends the SC command, the response from the drive will actually be the Hexadecimal equivalent of this 16-bit word. This hexadecimal value is considered the Status Code, and the equivalent hexadecimal value for each of the bits is given below.

Hex Value	Status Code bit definition
0001	Motor Enabled (Motor Disabled if this bit = 0)
0002	Sampling (for Quick Tuner)
0004	Drive Fault (check Alarm Code)
0008	In Position (motor is in position)
0010	Moving (motor is moving)
0020	Jogging (currently in jog mode)
0040	Stopping (in the process of stopping from a stop command)
0080	Waiting for an input (executing WI command)
0100	Saving (parameter data is being saved)
0200	Alarm present (check Alarm Code)
0400	Homing (executing an SH command)
0800	Wait Time (executing a WT command)

Hex Value	Status Code bit definition
1000	Wizard running (Timing Wizard is running)
2000	Checking encoder (Timing Wizard is running)
4000	Q Program is running
8000	Initializing (happens at power up) ; Servo Ready (for SV200 only)

Example: The drive is running a stored Q program (hex value 4000), it's in position (hex value 0008), and it's waiting for the input specified by the WI command (hex value 0080). The Status Code for this condition is 4088, and when the host sends the "SC" command the drive will respond with "SC=4088".

### "s" data register

Another way to retrieve the Status Code is to use the "s" data register. If the host sends the RLs command, the response from the drive will be the decimal equivalent of the 16-bit Status Code word. The diagram below shows the 16 bit assignments for the Status Code (which of course match the hexadecimal values above).

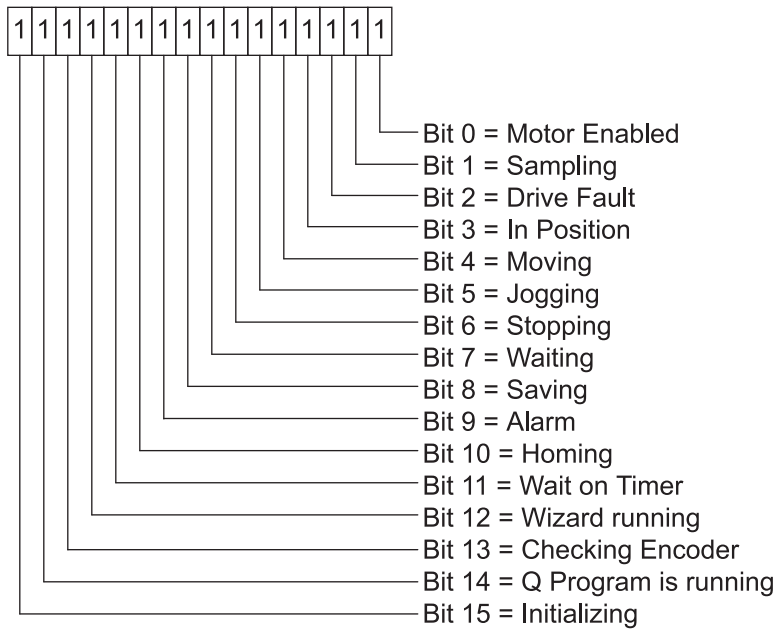

**Status Code 16-bit word**

Example: The drive is running a stored Q program (bit 14), it's in position (bit 3), and it's waiting for the input specified by the WI command (bit 7). The resulting Status Code binary word is 0100 0000 1000 1000. The decimal equivalent of this word 16,520, so the response from the drive to the RLs command will be "RLs=16520".

### A useful tool for converting between binary, decimal, and hexadecimal.

If you're using a Windows-based PC as a host with your drive (which you'll definitely be doing at some point during the project), you can use the Calculator utility that comes with Windows to convert Alarm and Status Codes between binary, decimal, and hexadecimal values. This utility is usually found in Start Menu, Programs, Accessories. Once open, make sure to choose Scientific view from the View menu of Calculator. This view provides radio buttons for Hex, Dec, and Bin.



To figure out what your Alarm or Status Code is telling you, first select the appropriate radio button (Hex for the AL or SC commands, Dec for the "f" and "s" registers), then enter the response from the drive. Now you can toggle between Hex, Dec, and Bin to compare the values to the tables and diagrams above. Note: Calculator does not show leading zeros in a binary number, so you may see less than 16 bits when you select Bin. That's OK, just start counting from the right with Bit 0 and you'll be able to determine the conditions set in the codes.

## LED and 7-Segment Display codes

In addition to the Alarm and Status codes, most drive alarms and faults as well as some status codes are displayed at the front of the drives, via either two-color flashing LED codes or 7-segment LED codes. The following tables show the various codes available with Applied Motion drives.

### BLuDC LED codes

Items in ***bold italic*** are Drive Faults.

		DESCRIPTION
-	solid	Motor disabled
-	flashing slowly	Motor enabled
-	flashing quickly	Q program running (Q drives only)
1	1	<b><i>position limit</i></b>
1	2	move attempted while disabled
2	1	CCW limit
2	2	CW limit
3	1	<b><i>over temperature (&gt; 85 deg C)</i></b>
3	2	bad flash
4	1	<b><i>over voltage (&gt; 55 Vdc)</i></b>
4	2	under voltage (< 18 Vdc)
5	1	<b><i>over current / short circuit</i></b>
5	2	current limit
6	1	<b><i>bad hall</i></b>
6	2	<b><i>bad encoder</i></b>
7	1	serial communication error

**For SV200 series alarm codes, see SV200 Hardware Manual**

## BLuAC 7-Segment codes



Items in ***bold italic*** are Drive Faults.

	Position Mode		<b><i>Over Temp</i></b>		Comm Error
	Velocity Mode		<b><i>Over Voltage</i></b>		Move attempted while disabled
	Torque Mode		<b><i>Under Voltage</i></b>		Drive Start-up
	Step Mode		<b><i>Over Current</i></b>		Bad Flash
	Si Mode		Current Limit		Comm Time-out
	Drive Disabled		<b><i>Hall Bad</i></b>		Stack Overflow
	<b><i>Position Limit</i></b>		<b><i>Bad Encoder</i></b>		Stack Underflow
	CCW Limit		Memory Failed		Q Program Running
	CW Limit		<b><i>Excess Regen</i></b>		Drive enabled when flashing





## SV LED codes

Items in ***bold italic*** are Drive Faults.

		DESCRIPTION
-	solid	Motor disabled
-	flashing slowly	Motor enabled
-	flashing quickly	Q program running (Q drives only)
1	1	<b><i>position limit</i></b>
1	2	move attempted while disabled
2	1	CCW limit
2	2	CW limit
3	1	<b><i>over temp</i></b>
3	2	<b><i>internal voltage out of range</i></b>
3	3	attempt to load blank Q segment
4	1	<b><i>over voltage</i></b>
4	2	under voltage
4	3	<b><i>Bad Si program instruction</i></b>
5	1	<b><i>over current / short circuit</i></b>
5	2	current limit
6	1	<b><i>bad hall</i></b>
6	2	<b><i>bad encoder</i></b>
7	1	serial communication error
7	2	bad flash

## STAC6 LED codes



Items in ***bold italic*** are Drive Faults.

		DESCRIPTION
-	solid	Motor disabled
-	flashing slowly	Motor enabled
-	flashing quickly	Q program running (Q drives only)
1	1	<b><i>motor stall (w/ optional encoder only)</i></b>
1	2	move attempted while disabled
2	1	CCW limit
2	2	CW limit
3	1	<b><i>over temp</i></b>
3	2	<b><i>excess regen</i></b>
4	1	<b><i>over voltage</i></b>
4	2	<b><i>under voltage</i></b>
4	3	<b><i>Bad Si program instruction</i></b>
5	1	<b><i>over current / short circuit</i></b>
5	2	motor resistance out of range

6	1	<b><i>open motor winding</i></b>
6	2	<b><i>bad encoder signal (w/ optional encoder only)</i></b>
7	1	serial communication error



## ST-Q/Si LED codes

Items in ***bold italic*** are Drive Faults.

		DESCRIPTION
-	solid	Motor disabled
-	flashing slowly	Motor enabled
-	flashing quickly	Q program running (Q drives only)
1	1	<b><i>motor stall (w/ optional encoder only)</i></b>
1	2	move attempted while disabled
2	1	CCW limit
2	2	CW limit
3	1	<b><i>over temp</i></b>
3	2	<b><i>internal voltage out of range</i></b>
4	1	<b><i>over voltage</i></b>
4	2	under voltage
4	3	<b><i>Bad Si program instruction</i></b>
5	1	<b><i>over current / short circuit</i></b>
6	1	<b><i>open motor winding</i></b>
6	2	<b><i>bad encoder signal (w/ optional encoder only)</i></b>
7	1	serial communication error



## ST-S LED codes

Items in ***bold italic*** are Drive Faults.

		DESCRIPTION
-	solid	Motor disabled
-	flashing slowly	Motor enabled
1	2	move attempted while disabled
2	1	CCW limit
2	2	CW limit
3	1	<b><i>over temp</i></b>
3	2	<b><i>internal voltage out of range</i></b>
4	1	<b><i>over voltage</i></b>
4	2	under voltage
5	1	<b><i>over current / short circuit</i></b>
6	1	<b><i>open motor winding</i></b>
7	1	serial communication error

## STM / SSM / STM / SWM / TSM / TXM LED codes

Items in ***bold italic*** are Drive Faults.

		DESCRIPTION
-	solid	Motor disabled
-	flashing slowly	Motor enabled
-	flashing quickly	Q program running (Q drives only)
1	1	<b><i>motor stall (w/ optional encoder only)</i></b>
1	2	move attempted while disabled
2	1	CCW limit
2	2	CW limit
3	1	<b><i>over temp</i></b>
3	2	<b><i>internal voltage out of range</i></b>
4	1	<b><i>over voltage</i></b>
4	2	under voltage
5	1	<b><i>over current / short circuit</i></b>
6	1	<b><i>open motor winding</i></b>
7	1	serial communication error

## Appendix F: Working with Inputs and Outputs

This Appendix covers I/O usage on drives from Applied Motion Products.

### Low v. High

When working with inputs and outputs it is important to remember the designations **low** and **high**. If current is flowing into or out of an input or output the logic state for that input/output is defined as **low** or closed. If no current is flowing, or the input/output is not connected, the logic state is **high** or open. A low state is represented by the “L” character in parameters of commands that affect inputs/outputs. For example, WIX4L means “wait for input X4 low”, and SO1L means “set output 1 low”. A high state is represented by the “H” character.

When working with the analog inputs, “L” designates an analog value lower than the value set by the AT command. Similarly “H” designates an analog value greater than the value set by the AT command.

### “X” Marks The Spot

When using a dual input command, both I/O points used must reside on the same connector. That is, if an “X” input such as X2 is used for the first input, the second input is assumed to use an “X” as well since it must reside on the same connector. Since it is not possible to mix I/O from different banks, there is no need for the “X” character on the second I/O point. See the “Parameter Details” section in the tables below for specific details.

### Parameter Details

The following tables show general I/O details for commands as they relate to specific drives. There are exceptions to these general rules, so be sure to check the command pages for the specific SCL commands you wish to implement, as well as the list of exceptions at the end of this section. For specific voltage or wiring questions, consult your drive’s hardware manual.

#### Input Parameter Details

BLu-S, BLu-Q  
STAC6-S, STAC6-Q, STAC6-C

Parameter #1	Optional “X”, input number, input condition NOTE: Including/omitting the optional “X” has no effect on the execution of the command.
- units	Optional “X”, integer, letter
- range	- integer: 0 (encoder index, if present), 1 - 7, 8 (Analog Command), 9 (AIN1), : (AIN2) - letter: L = Low, H = High, F = Falling Edge, R = Rising Edge
Parameter #2	Input number, input condition
- units	integer, letter
- range	- integer: 0 (encoder index, if present), 1 - 7, 8 (Analog Command), 9 (AIN1), : (AIN2) - letter: L = Low, H = High, F = Falling Edge, R = Rising Edge

BLu-SE, BLu-QE, BLu-Si  
STAC6-SE, STAC6-QE, STAC6-Si

Parameter #1	Optional "X", input number, input condition NOTE: Including the optional "X" indicates that the input(s) resides on the IN/OUT1 or main drive board connector. Omitting the "X" indicates that the input(s) resides on the IN/OUT2 or top board connector.
- units	Optional "X", integer, letter
- range	- integer for IN/OUT1 or main drive board connector: X0 (encoder index, if present), X1 - X7, X8 (Analog Command), X9 (AIN1), X: (AIN2)  -integer for IN/OUT2 or top board connector: 1 - 8  - letter: L = Low, H = High, F = Falling Edge, R = Rising Edge
Parameter #2	Input number, input condition
- units	integer, letter
- range	- integer for IN/OUT1 or main drive board connector: 0 (encoder index, if present), 1 - 7, 8 (Analog Command), 9 (AIN1), : (AIN2)  -integer for IN/OUT2 or top board connector: 1 - 8  - letter: L = Low, H = High, F = Falling Edge, R = Rising Edge

STAC5-S, SVAC3-S

Parameter #1	Optional "X", input number, input condition NOTE: Including/omitting the optional "X" has no effect on the execution of the command.
- units	integer, letter
- range	- integer: 0 (encoder index, if present), 1 - 4, 8 (AIN)  - letter: L = Low, H = High, F = Falling Edge, R = Rising Edge
Parameter #2	input number, input condition
- units	integer, letter
- range	- integer: 0 (encoder index, if present), 1 - 4, 8 (AIN)  - letter: L = Low, H = High, F = Falling Edge, R = Rising Edge

STAC5-Q, STAC5-IP  
SVAC3-Q, SVAC3-IP

Parameter #1	Optional "X", input number, input condition NOTE: Including the optional "X" indicates that the input(s) resides on the IN/OUT1 connector (DB-15). Omitting the "X" indicates that the input(s) resides on the OPT2 connector (DB-25).
- units	Optional "X", integer, letter
- range	- integer for IN/OUT1 connector: X0 (encoder index, if present), X1 - X4, X8 (AIN)  - integer for OPT2 connector: 1 - 8  - letter: L = Low, H = High, F = Falling Edge, R = Rising Edge
For those commands with Parameter #2	input number, input condition
- units	integer, letter
- range	- integer for IN/OUT1 connector: 0 (encoder index, if present), 1 - 4, 8 (AIN)  - integer for OPT2 connector: 1 - 8  - letter: L = Low, H = High, F = Falling Edge, R = Rising Edge

ST-Q, ST-Si, ST-C, ST-IP  
SV7-S, SV7-Q, SV7-Si, SV7-C, SV7-IP

Parameter #1	Optional "X", input number, input condition NOTE: Including/omitting the optional "X" has no effect on the execution of the command.
- units	integer, letter
- range	- integer: 0 (encoder index, if present), 1 - 8, 9 (Analog Command), : (AIN1), ; (AIN2)  - letter: L = Low, H = High, F - Falling Edge, R = Rising Edge
Parameter #2	input number, input condition
- units	integer, letter
- range	- integer: 0 (encoder index, if present), 1 - 8, 9 (Analog Command), : (AIN1), ; (AIN2)  - letter: L = Low, H = High, F = Falling Edge, R = Rising Edge

ST-S, ST-Plus  
 STM17S, STM17Q  
 STM23S, STM23Q  
 SSM23IP  
 STM/SWM/TXM24S  
 STM/SWM/TXM24Q

Parameter #1	Optional "X", input number, input condition NOTE: Including/omitting the optional "X" has no effect on the execution of the command.
- units	optional "X", integer, letter
- range	- integer: 0 (encoder index, if present), 1 (STEP), 2 (DIR), 3 (EN), 4 (AIN)  - letter: L = Low, H = High, F = Falling Edge, R = Rising Edge
Parameter #2	input number, input condition
- units	integer, letter
- range	- integer: 0 (encoder index, if present), 1 (STEP), 2 (DIR), 3 (EN), 4 (AIN)  - letter: L = Low, H = High, F = Falling Edge, R = Rising Edge

### STM17C

Parameter #1	Optional "X", input number, input condition NOTE: Including/omitting the optional "X" has no effect on the execution of the command.
- units	Optional "X", integer, letter
- range	- integer: 0 (encoder index, if present), 1 - 3, 4 (AIN)  - letter: L = Low, H = High, F = Falling Edge, R = Rising Edge
Parameter #2	input number, input condition
- units	integer, letter
- range	- integer: 0 (encoder index, if present), 1 - 3, 4 (AIN)  - letter: L = Low, H = High, F = Falling Edge, R = Rising Edge

STM23C  
STM24C

Parameter #1	Optional "X", input number, input condition NOTE: Including/omitting the optional "X" has no effect on the execution of the command.
- units	Optional "X", integer, letter
- range	- integer: 0 (encoder index, if present), 1 - 3 - letter: L = Low, H = High, F = Falling Edge, R = Rising Edge
Parameter #2	input number, input condition
- units	integer, letter
- range	- integer: 0 (encoder index, if present), 1 - 3 - letter: L = Low, H = High, F = Falling Edge, R = Rising Edge

STM24SF, STM24QF

Drives with Flex I/O allow a user to configure I/O1 through I/O4 as either inputs or outputs by using the Set Direction (SD) command.

Parameter #1	Optional "X", input number, input condition NOTE: Including/omitting the optional "X" has no effect on the execution of the command.
- units	Optional "X", integer, letter
- range	- integer: 0 (encoder index, if present), 1 - 4, 5 (AIN) - letter: L = Low, H = High, F = Falling Edge, R = Rising Edge
Parameter #2	input number, input condition
- units	integer, letter
- range	- integer: 0 (encoder index, if present), 1 - 4, 5 (AIN) - letter: L = Low, H = High, F = Falling Edge, R = Rising Edge



## Exceptions:

- When using the Follow Encoder or Hand Wheel commands (FE or HW, respectively), the master encoder channels A and B must be wired to drive inputs STEP/X1/IN1 and DIR/X2/IN2. In these modes, these inputs must not be used for sensor inputs.
- Using the On Input (OI) command with no parameter will disable the interrupt function.
- The Seek Home (SH) command makes use of the drive's CW and CCW limit functions. As such, the home sensor may not be wired to the following inputs:

STAC5-S:	X1, X2	STM17-S/Q:	STEP, DIR
STAC5-Q/IP:	IN7, IN8	STM17-C:	IN1, IN2
SVAC3-S:	X1, X2	STM23-S/Q:	STEP, DIR
SVAC3-Q/IP:	IN7, IN8	STM23-C:	IN1, IN2
BLu:	X6, X7	STM24-SF/QF:	I/O3, I/O4
STAC6:	X6, X7	STM24-C:	IN1, IN2
ST-S/Plus:	STEP, DIR		
ST-Q/Si/C/IP:	X7, X8		
SV7:	X7, X8		

## Output Parameter Details

**For SV200 series, see SV200 Hardware Manual and SVX Servo Suite software**

BLu-S, BLu-Q

STAC6-S, STAC6-Q, STAC6-C

Parameter #1	Optional "Y", output number, output condition NOTE: Including/omitting the optional "Y" has no effect on the execution of the command.
- units	Optional "Y", integer, letter
- range	- integer: 1 - 3  - letter: L = Low, H = High

BLu-SE, BLu-QE, BLu-Si

STAC6-SE, STAC6-QE, STAC6-Si

Parameter #1	Optional "Y", output number, output condition NOTE: Including the optional "Y" indicates that the output(s) resides on the IN/OUT1 or main drive board connector. Omitting the "Y" indicates that the output(s) resides on the IN/OUT2 or top board connector.
- units	Optional "Y", integer, letter
- range	- integer for IN/OUT1 or main drive board connector: Y1 - Y3 - integer for IN/OUT2 or top board connector: 1 - 4  - letter: L = Low, H = High

STAC5-S  
SVAC3-S

Parameter #1	Optional "Y", output number, output condition NOTE: Including/omitting the optional "Y" has no effect on the execution of the command.
- units	Optional "Y", integer, letter
- range	- integer: 1 - 2  - letter: L = Low, H = High

STAC5-Q, STAC5-IP  
SVAC3-Q, SVAC3-IP

Parameter #1	Optional "Y", output number, output condition NOTE: Including the optional "Y" indicates that the output(s) resides on the IN/OUT1 connector (DB-15). Omitting the "Y" indicates that the output(s) resides on the OPT2 connector (DB-25).
- units	Optional "Y", integer, letter
- range	- integer for IN/OUT1 connector: Y1- Y2  - integer for OPT2 connector: 1 - 4  - letter: L = Low, H = High

ST-Q, ST-Si, ST-C, ST-IP  
SV7-S-SV7-Q, SV7-Si, SV7-C, SV7-IP

Parameter #1	Optional "Y", output number, output condition NOTE: Including/omitting the optional "Y" has no effect on the execution of the command.
- units	Optional "Y", integer, letter
- range	- integer: 1 - 4  - letter: L = Low, H = High

ST-S, ST-Plus  
 STM17S, STM17Q, STM17C  
 STM23S, STM23Q, STM23C  
 STM24C, SSM23IP, SWM,  
 TSM, TXM

Parameter #1	Optional "Y", output number, output condition NOTE: Including/omitting the optional "Y" has no effect on the execution of the command.
- units	Optional "Y", integer, letter
- range	- integer: 1  - letter: L = Low, H = High

STM24SF, STM24QF

Drives with Flex I/O allow a user to configure I/O1 through I/O4 as either inputs or outputs by using the Set Direction (SD) command.

Parameter #1	Optional "Y", output number, output condition NOTE: Including/omitting the optional "Y" has no effect on the execution of the command.
- units	Optional "Y", integer, letter
- range	- integer: 1 - 4  - letter: L = Low, H = High, F - Falling Edge, R = Rising Edge

# Appendix G: eSCL (SCL over Ethernet) Reference

## Introduction

eSCL is Applied Motion Products' language for commanding and querying motion control products over Ethernet. It is supported by several motion control devices, including the ST5-Q-E, ST10-Q-E and SV7-Q-E. In addition to sending commands to a drive from a host in real time, you can also use our Q Programmer software to embed sequences of commands, called Q Programs, in a drive. These programs can be set to execute automatically at power up, or can be triggered by commands sent from the host.

This guide is intended to help you connect and configure your drive and to help you start writing your own eSCL host application.

## Getting Started

There are three steps required to create an eSCL application with your new Applied Motion Products motor driver. Each of these is explained in a separate section of this manual.

- Connect the drive to your PC. This includes getting the drive physically connected to your network (or directly to the PC), setting the drive's IP address, and setting the appropriate networking properties on your PC.
- Configure the drive for your motor and application. For step motor drives, you'll need to use a suitable version of our Configurator software. For servos, use Quick Tuner.
- Create your own application. This guide includes code examples in Visual Basic and C# to help you get started. You can download the example in their entirety, from our website, but we recommend reading the explanations in the guide first.

## Connecting a Drive to Your PC

This process requires three steps

- Get the drive physically connected to your network (or directly to the PC)
- Set the drive's IP address
- Set the appropriate networking properties on your PC.

Addresses, Subnets, and Ports

Every device on an Ethernet network must have a unique IP address. In order for two devices to communicate with each other, they must both be connected to the network and they must have IP addresses that are on the same subnet. A subnet is a logical division of a larger network. Members of one subnet are generally not able to communicate with the members of another. Subnets are defined by the choices of IP addresses and subnet masks.

If you want to know the IP address and subnet mask of your PC, select Start...All Programs...Accessories...Command Prompt. Then type "ipconfig" and press Enter. You should see something like this:

*Point of Interest*

AMP recommends performing all Ethernet configuration of the drive while connected directly to a PC via a CAT-5 Ethernet cable. This avoids many potential communication problems associated with frequent IP address changes on a larger network.

Once fully configured, the drive may be used on a plant network without issue.

See the section titled "ARP Tables - the Ghost in the Machine" below for further information.

```
Windows IP Configuration

Ethernet adapter Local Area Connection:

    Connection-specific DNS Suffix . . . : 
    IP Address . . . . . : 192.168.0.22
    Subnet Mask . . . . . : 255.255.255.0
    Default Gateway . . . . . : 192.168.0.254
```

If your PC's subnet mask is set to 255.255.255.0, a common setting known as a Class C subnet mask, then your machine can only talk to another network device whose IP address matches yours in the first three octets. (The numbers between the dots in an IP address are called octets.) For example, if your PC is on a Class C subnet and has an IP address of 192.168.0.20, it can talk to a device at 192.168.0.40, but not one at 192.168.1.40. If you change your subnet mask to 255.255.0.0 (Class B) you can talk to any device whose first two octets match yours. Be sure to ask your system administrator before doing this. Your network may be segmented for a reason.

Your drive includes a 16 position rotary switch for setting its IP address. The factory default address for each switch setting is shown in the table to the right.

Settings 1 through E can be changed using the STAC Configurator software (use Quick Tuner for servo drives). Setting 0 is always "10.10.10.10", the universal recovery address. If someone were to change the other settings and not write it down or tell anyone (I'm not naming names here, but you know who I'm talking about) then you will not be able to communicate with your drive. The only way to "recover" it is to use the universal recovery address.

Setting F is "DHCP", which commands the drive to get an IP address from a DHCP server on the network. The IP address automatically assigned by the DHCP server may be "dynamic" or "static" depending on how the administrator has configured DHCP. The DHCP setting is reserved for advanced users.

Your PC, or any other device that you use to communicate with the drive, will also have a unique address.

On the drive, switch settings 1 through E use the standard class B subnet mask (i.e. "255.255.0.0"). The mask for the universal recovery address is the standard class A (i.e. "255.0.0.0").

One of the great features of Ethernet is the ability for many applications to share the network at the same time. Ports are used to direct traffic to the right application once it gets to the right IP address. The UDP eSCL port in our drives is 7775. To send and receive commands using TCP, use port number 7776. You'll need to know this when you begin to write your own application. You will also need to choose an open (unused) port number for your application. Our drive doesn't care what that is; when the first command is sent to the drive, the drive will make note of the IP address and port number from which it originated and direct any responses there. The drive will also refuse any traffic from other IP addresses that is headed for the eSCL port. The first application to talk to a drive "owns" the drive. This lock is only reset when the drive powers down.

If you need help choosing a port number for your application, you can find a list of commonly used port numbers at <http://www.iana.org/assignments/port-numbers>.

One final note: Ethernet communication can use one or both of two "transport protocols": UDP and TCP. eSCL commands can be sent and received using either protocol. UDP is simpler and more efficient than TCP, but TCP is more reliable on large or very busy networks where UDP packets might occasionally be dropped.

## IP Address\*

0	10.10.10.10
1	192.168.1.10
2	192.168.1.20
3	192.168.1.30
4	192.168.0.40
5	192.168.0.50
6	192.168.0.60
7	192.168.0.70
8	192.168.0.80
9	192.168.0.90
A	192.168.0.100
B	192.168.0.110
C	192.168.0.120
D	192.168.0.130
E	192.168.0.140
F	DHCP

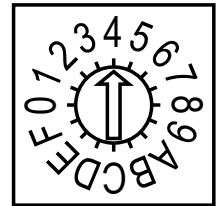

## Option 1: Connect a Drive to Your Local Area Network

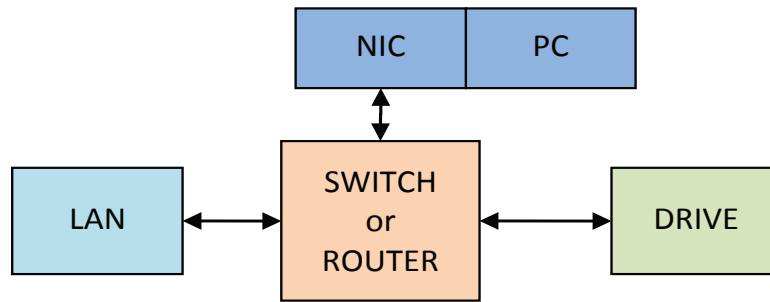

If you have a spare port on a switch or router and if you are able to set your drive to an IP address that is compatible with your network, and not used by anything else, this is a simple way to get connected. This technique also allows you to connect multiple drives to your PC. If you are on a corporate network, please check with your system administrator before connecting anything new to the network. He or she should be able assign you a suitable address and help you get going.

If you are not sure which addresses are already used on your network, you can find out using “Angry IP scanner”, which can be downloaded free from <http://www.angryip.org/w/Download>. But be careful: an address might appear to be unused because a computer or other device is currently turned off. And many networks use dynamic addressing where a DHCP server assigns addresses “on demand”. The address you choose for your drive might get assigned to something else by the DHCP server at another time.

Once you’ve chosen an appropriate IP address for your drive, set the rotary switch according the address table above. If none of the default addresses are acceptable for your network, you can enter a new table of IP addresses using *Configurator*. If your network uses addresses starting with 192.168.0, the most common subnet, you will want to choose an address from switch settings 4 through E. Another common subnet is 192.168.1. If your network uses addresses in this range, the compatible default selections are 1, 2 and 3.

If your PC address is not in one of the above private subnets, you will have to change your subnet mask to 255.255.0.0 in order to talk to your drive. To change your subnet mask:

1. On Windows XP, right click on “My Network Places” and select properties. On Windows 7, click Computer. Scroll down the left pane until you see “Network”. Right click and select properties. Select “Change adapter settings”
2. You should see an icon for your network interface card (NIC). Right click and select properties.
3. Scroll down until you see “Internet Properties (TCP/IP)”. Select this item and click the Properties button. On Windows 7 and Vista, look for “(TCP/IPv4)”

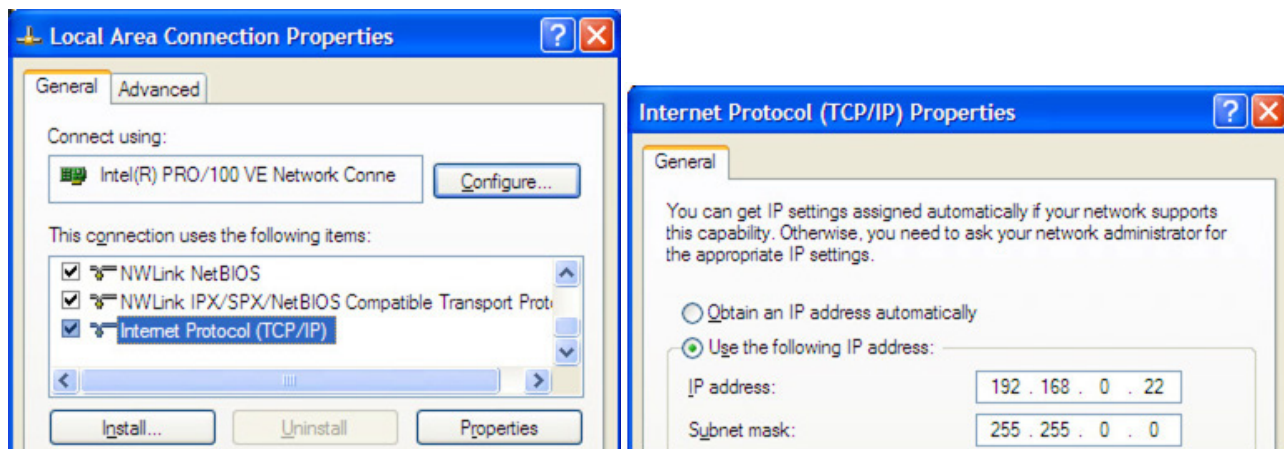

- If the option “Obtain an IP address automatically” is selected, your PC is getting an IP address and a subnet mask from the DHCP server. Please cancel this dialog and proceed to the next section of this manual: “Using DHCP”.
- If the option “Use the following IP address” is selected, life is good. Change the subnet mask to “255.255.0.0” and click OK.

## Using DHCP

If you want to use your drive on a network that where all or most of the devices use dynamic IP addresses supplied by a DHCP server, set the rotary switch to “F”. When the drive is connected to the network and powered on, it will obtain an IP address and a subnet mask from the server that is compatible with your PC. The only catch is that you won’t know what address the server assigns to your drive. Ethernet Configurator can find your drive using the Drive Discovery feature, as long as your network isn’t too large. With the drive connected to the network and powered on, select Drive Discovery from the Drive menu.

You will see a dialog such as this:

Normally, Drive Discovery will only detect one network interface card (NIC), and will select it automatically. If you are using a laptop and have both wireless and wired network connections, second NIC may appear. Please select the NIC that you use to connect to the network to which you’ve connected your drive. Then click OK. Drive Discovery will notify you as soon as it has detected a drive.

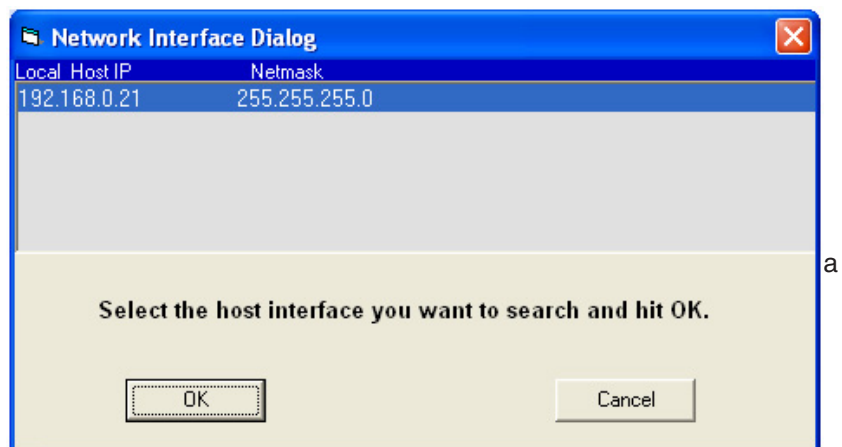

If you think this is the correct drive, click Yes. If you’re not sure, click Not Sure and Drive Discovery will look for additional drives on you network. Once you’ve told Drive Discovery which drive is yours, it will automatically enter that drive’s IP address in the IP address text box so that you are ready to communicate.

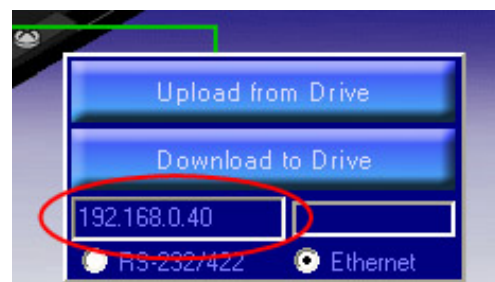
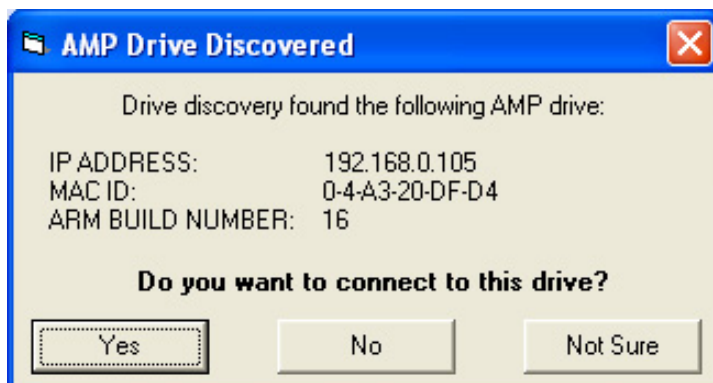

## Option 2: Connect a Drive Directly to Your PC

1. Connect one end of a CAT5 Ethernet cable into the LAN card (NIC) on your PC and the other into the drive.
2. Set the IP address on the drive to “10.10.10.10” by setting the rotary switch at “0”.
3. To set the IP address of your PC:
  - a. On Windows XP, right click on “My Network Places” and select properties.
  - b. On Windows 7, click Computer. Scroll down the left pane until you see “Network”. Right click and select properties. Select “Change adapter settings”
4. You should see an icon for your network interface card (NIC). Right click and select properties.
  - a. Scroll down until you see “Internet Properties (TCP/IP)”. Select this item and click the Properties button.
  - b. On Windows 7 and Vista, look for “(TCP/IPv4)”

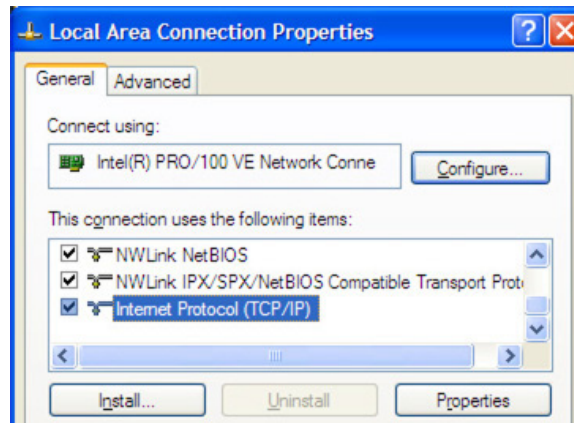

5. Select the option “Use the following IP address”. Then enter the address “10.10.10.11”. This will give your PC an IP address that is on the same subnet as the drive. Windows will know to direct any traffic intended for the drive’s IP address to this interface card.
6. Next, enter the subnet mask as “255.255.255.0”.
7. Be sure to leave “Default gateway” blank. This will prevent your PC from looking for a router on this subnet.

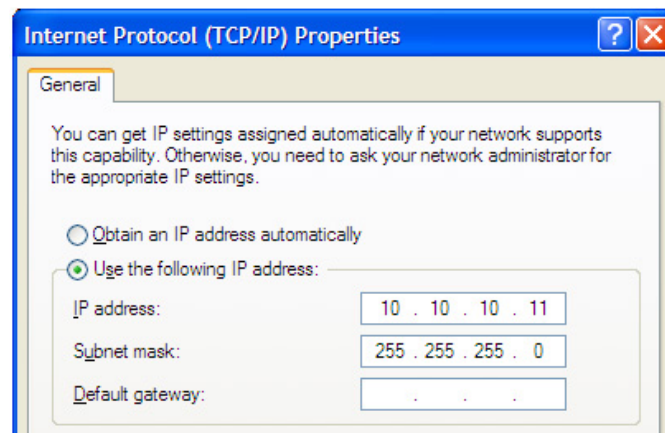

8. Because you are connected directly to the drive, anytime the drive is not powered on your PC may annoy you with a small message bubble in the corner of your screen saying “The network cable is unplugged.”



### Option 3: Use Two Network Interface Cards (NICs)

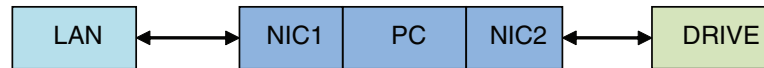

This technique allows you to keep your PC connected to your LAN, but keeps the drive off the LAN, preventing possible IP conflicts or excessive traffic.

1. If you use a desktop PC and have a spare card slot, install a second NIC and connect it directly to the drive using a CAT5 cable. You don't need a special "crossover cable"; the drive will automatically detect the direct connection and make the necessary physical layer changes.
2. If you use a laptop and only connect to your LAN using wireless networking, you can use the built-in RJ45 Ethernet connection as your second NIC.
3. Set the IP address on the drive to "10.10.10.10" by setting the rotary switch at "0".
4. To set the IP address of the second NIC:
  - a. On Windows XP, right click on "My Network Places" and select properties.
  - b. On Windows 7, click Computer. Scroll down the left pane until you see "Network". Right click and select properties. Select "Change adapter settings"

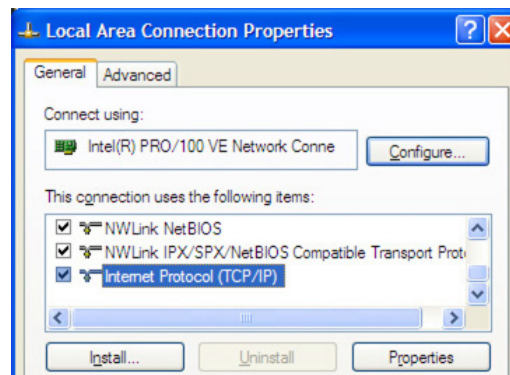

5. You should see an icon for your newly installed NIC. Right click again and select properties.
  - a. Scroll down until you see "Internet Properties (TCP/IP)". Select this item and click the Properties button.
  - b. On Windows 7 and Vista, look for "(TCP/IPv4)"
6. Select the option "Use the following IP address". Then enter the address "10.10.10.11". This will give your PC an IP address that is on the same subnet as the drive. Windows will know to direct any traffic intended for the drive's IP address to this interface card.
7. Next, enter the subnet mask as "255.255.255.0". Be sure to leave "Default gateway" blank. This will prevent your PC from looking for a router on this subnet.

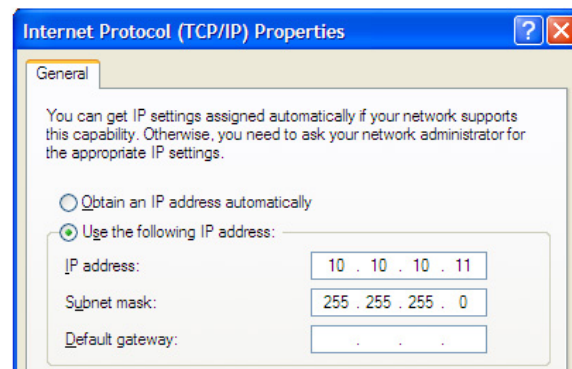

8. Because you are connected directly to the drive, anytime the drive is not powered on your PC will annoy you with a small message bubble in the corner of your screen saying "The network cable is unplugged."

## ARP Tables - The Ghost in the Machine

ARP, which stands for “Address Resolution Protocol”, is a low-level router function that enables traffic to be correctly routed on the Ethernet network. It is handled automatically by the router and is normally transparent to the user.

All network devices need to have two things: a MAC ID and an IP address.

- The MAC ID is a unique identifier that is assigned to the chip on the network interface device. You can think of it as a network serial number.
- The IP address is just that - an address. Like a street address on your house. IP addresses can be changed - MAC ID's cannot.

The following diagram shows a basic network. Note that each device has both a MAC ID and IP address. The router maintains an ARP table, which is really just a list that matches MAC ID's to IP addresses. An entry is created for every device on the network.

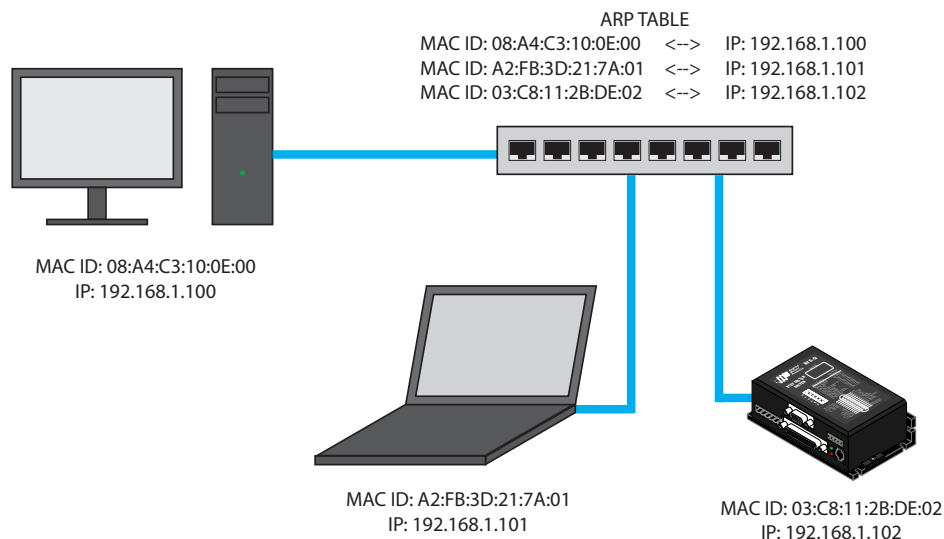

It should be noted that computers maintain a local ARP table as well, tracking other devices they've interacted with. This is an important point because the ARP table on a PC will typically refresh more frequently than those on a network router or switch.

So why do we care? Your application will probably require changing the IP address of a drive. The ARP table must then be refreshed to show the same MAC ID with a different IP address. This is usually not an issue if the drive is directly connected to the PC used to configure it, because the local ARP table will likely refresh quickly enough to catch the new IP address and re-establish a connection.

The problem comes when the drive is connected through a router during configuration. In this scenario it is entirely possible for IP address changes to happen more frequently than the ARP table can refresh itself. Most routers do not allow users to refresh the ARP table directly, as this poses a significant network security risk. The router must actually be rebooted to force a reset of the ARP table and allow a connection with the new IP address. Obviously this is not an ideal solution.

For this reason we recommend that all configuration be performed while directly connected to a PC. Do not use a router for drive configuration. Once an IP address is assigned the drive may be placed on the plant network without worry.

NOTE: If you find that you are changing IP addresses often and the connection becomes unreliable, it may be necessary to force a refresh of your PC's local ARP table. This can be accomplished by opening a command window and using the command `arp -d`. You must have administrator privileges on your PC to do this.

## Configuring Your Drive

Three Windows programs are available from Applied Motion Products for use with our Ethernet drives. These programs are included on the CD that accompanies each drive and the most recent version is always available at [www.applied-motion.com](http://www.applied-motion.com).

*ST Configurator* is used to configure your stepper drive and motor. It can also be used to change the selection of drive IP addresses. *ST Configurator* includes extensive built-in help screens and manuals.

*Quick Tuner* is used to configure and tune servo drives. The Quick Tuner Manual is automatically installed in the Applied Motion Products program menu when you install Quick Tuner.

*Q Programmer* will be needed if you want to embed programs in the non-volatile memory of your drive, either to run automatically at power up or to be triggered by commands sent from a host.

## Creating Your Own Application

To create your own application, you will need to choose a programming language, learn how SCL commands and responses are encapsulated in UDP packets, and learn to use your programming language's interface to the network.

### UDP Packet Format

eSCL is based on Applied Motion's Serial Command Language (SCL), an ASCII-based language with roots in RS-232 and RS-485 communication. eSCL drives support the full SCL and Q command sets, and utilize the speed and reliability of Ethernet. Commands and responses are encapsulated in the payload of User Datagram Protocol (UDP) packets, and are transmitted using standard Ethernet hardware and standard TCL/IP stacks.

### Sending Commands to a Drive

An eSCL UDP packet consists of three parts, the header (binary 07), the SCL string (a sequence of ASCII encoded characters) and the SCL terminator (ASCII carriage return, 13)

header	SCL string	<cr>

Example: Sending "RV"

- SCL Header = 07 (two bytes)
- R = ASCII 82
- V = ASCII 86
- <cr> (ASCII carriage return) = 13

header		"RV"		<cr>
0	7	82	86	13

### Receiving Responses from a Drive

A typical response to "RV" would be "RV=103<cr>" which would be formatted as

header		"RV=103"						<cr>
0	7	82	86	61	49	48	51	13

## Example Programs

Both example programs are available for download at [www.applied-motion.com/example\\_code](http://www.applied-motion.com/example_code). You should still read this section so that you understand the key elements of the code and what tradeoffs you may encounter.

### Visual Basic 6

Even though VB6 is an older language, its refreshing simplicity makes it a compelling choice for quickly developing an Ethernet application.

To communicate over Ethernet from VB6, you'll need the Winsock control (MSWINSCK.OCX), which is included in the Professional and Enterprise editions of the language. To configure an instance of Winsock, you must specify the protocol as UDP, choose a local port number, and set the remote IP address and port number to match the drive. In the code example below, 7775 is the port of the drive. `driveIPAddress` is the IP address of the drive ("10.10.10.10" or "192.168.0.130" for example). 7777 is the port of the PC.

```
Winsock1.RemotePort = 7775
Winsock1.RemoteHost = driveIPAddress
Winsock1.Protocol = sckUDPProtocol
Winsock1.Bind 7777
// if port 7777 is in use by another application, you will get an error.
// that error should be trapped using the On Error statement
// and an alternate port should be chosen.
```

Sending "RV" command:

```
Dim myPacket(0 to 4) as Byte ' declare a byte array just large enough

myPacket(0) = 0             ' first byte of SCL opcode
myPacket(1) = 7             ' second byte of SCL opcode
myPacket(2) = "R"           ' R
myPacket(3) = "V"           ' V
myPacket(4) = vbCR          ' carriage return
Winsock1.SendData myPacket
```

To receive a response, you will need to place some code in the `Winsock_DataArrival` event. This event is automatically declared as soon as you add a Winsock control to your form. The `DataArrival` event will automatically trigger each time a packet is received. The code below extracts the SCL response from the UDP payload and displays it in a message box.

```
Private Sub Winsock1_DataArrival(ByVal bytesTotal As Long)
    Dim udpData() As Byte, n As Integer
    Dim hexbyte As String, packetID As Long, SCLrx As String
    Winsock1.GetData udpData
    ' remotehost gets clobbered when packet rec'd,
    ' next line fixes it
    Winsock1.RemoteHost = Winsock1.RemoteHostIP
    ' first 16 bits of packet are the ID (opcode)
    If UBound(udpData) >= 1 Then
        packetID = 256 * udpData(0) + udpData(1)
        If packetID = 7 then ' SCL response
            SCLrx = ""
            For n = 2 To UBound(udpData)
                SCLrx = SCLrx & Chr(udpData(n))
            Next n
            MsgBox SCLrx
        End If
    End If
End Sub
```

## C#.NET

The .NET languages are Microsoft's modern, object oriented Windows application building tools and include robust Ethernet support. We present this example in C#.

Make sure your project includes this line, providing access to an Ethernet socket:

```
using System.Net.Sockets;
```

In your form header you must declare a `UdpClient` object and create an instance, which can be done in the same line. The local port number is included in the "new `UdpClient`" call. This is the port number that will be reserved on the PC for your application.

```
static UdpClient udpClient = new UdpClient(7777);
```

To open the connection, invoke the `Connect` method, specifying the drive's IP address and port number:

```
udpClient.Connect("192.168.0.130", 7775);
```

To send "RV" to the drive:

```
//create a string loaded with the SCL command
Byte[] SCLstring = Encoding.ASCII.GetBytes("RV");
// create a byte array that will be used for the actual
// transmission
Byte[] sendBytes = new Byte[SCLstring.Length + 3];
// insert opcode (07 is used for all SCL commands)
sendBytes[0] = 0;
sendBytes[1] = 7;
// copy string to the byte array
System.Array.Copy(SCLstring, 0, sendBytes, 2, SCLstring.Length);
// insert terminator
sendBytes[sendBytes.Length - 1] = 13; // CR
```

```
// send it to the drive
udpClient.Send(sendBytes, sendBytes.Length);
```

Getting responses back from the drive in C# is a more complicated than VB6. You have two choices: poll for a response or create a callback function that will provide a true receive event.

Polling is easier to code but less efficient because you must either sit in a loop waiting for an expected response or run a timer to periodically check for data coming in. Since the choice depends on your programming style and the requirements of your application, we preset both techniques.

### Polling for an incoming packet

The same `UdpClient` object that you use to send packets can be used to retrieve incoming responses from the drive. The `Available` property will be greater than zero if a packet has been received. To retrieve a packet, assign the `Receive` property to a `Byte` array. You must create an `IPEndPoint` object in order to use the `Receive` property.

```
private void UDPpoll()
{
    // you can call this from a timer event or a loop
    if (udpClient.Available > 0) // is there a packet ready?
    {
        IPEndPoint RemoteIpEndPoint = new IPEndPoint(IPAddress.Any, 0);
        try
        {
            // Get the received packet. Receive method blocks
            // until a message returns on this socket from a remote host,
            // so always check .Available to see if a packet is ready.
            Byte[] receiveBytes = udpClient.Receive(ref RemoteIpEndPoint);
            // strip opcode
            Byte[] SCLstring = new byte[receiveBytes.Length - 2];
            for (int i = 0; i < SCLstring.Length; i++)
                SCLstring[i] = receiveBytes[i + 2];
            string returnData = Encoding.ASCII.GetString(SCLstring);
            AddToHistory(returnData);
        }
        catch (Exception ex)
        {
            // put your error handler here
            Console.WriteLine(ex.ToString());
        }
    }
}
```

## Creating a receive event using a call back function

First, create a function to handle incoming packets. This function must contain two local objects: a `UdpClient` and an `IPEndPoint`. The call back function will be passed an `IAsyncResult` object that contains a reference to the UDP connection. The local `IPEndPoint` object is passed to the `UdpClient`'s `EndReceive` property to retrieve the packet.

```
public void ReceiveCallback(IAsyncResult ar)
{
    int opcode;
    UdpClient u = (UdpClient)((UdpState)(ar.AsyncState)).u;
    IPEndPoint e = (IPEndPoint)((UdpState)(ar.AsyncState)).e;

    Byte[] receiveBytes = u.EndReceive(ar, ref e);
    // get opcode
    opcode = 256 * receiveBytes[0] + receiveBytes[1];
    if (opcode == 7) // SCL response
    {
        string receiveString = Encoding.ASCII.GetString(receiveBytes);
        Byte[] SCLstring = new Byte[receiveBytes.Length - 2];
        // remove opcode
        System.Array.Copy(receiveBytes, 2, SCLstring, 0, SCLstring.
Length);
        receiveString = Encoding.ASCII.GetString(SCLstring);
        AddToHistory(receiveString);
    }
    else if (opcode == 99) // ping response
    {
        MessageBox.Show("Ping!", "eSCL Utility", MessageBoxButtons.OK,
MessageBoxIcon.Information);
    }
}
```

The call back function will not be called unless it is “registered” with the `UdpClient` object using the `BeginReceive` method, as shown below. `StartRecvCallback` can be called from the Form Load event. It must also be re-registered each time it is called (this is to prevent recursion), which is most easily accomplished by making a call to `StartRecvCallback` each time you send a packet.

```
private void StartRecvCallback()
{
    UdpState s = new UdpState();
    s.e = new IPEndPoint(IPAddress.Any, 0);
    s.u = udpClient;
    udpClient.BeginReceive(new AsyncCallback(ReceiveCallback), s);
}
```

This example requires that you declare a class called `UdpState` as described below.

```
class UdpState
{
    public UdpClient u;
    public IPEndPoint e;
}
```

As if this event driven technique wasn't quirky enough, it also creates a threading error unless the following statement is included in the form load event

```
// this must be so for callbacks which operate in a different thread
CheckForIllegalCrossThreadCalls = false;
```



## Further Reading

The following materials can be downloaded from [www. Applied-motion.com](http://www.Applied-motion.com).

- The eSCL Utility will help you get familiar with the SCL language.
- ST Configuration Ethernet is needed to configure the ST5-QE and ST10-QE step motor drives. This application also includes extensive help screens.
- QuickTuner is used to configure and tune SV7 servo drives. . Quick Tuner also includes extensive help screens.
- Visual Basic and C# example projects can be downloaded from the software page.

To learn more about networking using Ethernet, we recommend reading Sams *Teach Yourself TCP/IP in 24 Hours*, available from [amazon.com](http://amazon.com) and other fine booksellers.

## Appendix H: EtherNet/IP

EtherNet/IP products, designated by the letters “IP” in the model number, provide access to Q and SCL functionality over EtherNet/IP networks. This appendix details which commands are available and how to encapsulate them into EtherNet/IP and CIP packets. It is assumed that the user has a working knowledge of EtherNet/IP as it relates to the controller being used, as this chapter will not explain general EtherNet/IP implementation details.

AMP offers both Class 1 and Class 3 type connections, each of which are useful for specific tasks. Class 1 connections are useful for high bandwidth tasks such as monitoring specific functions of the drive, while Class 3 connections are used for sending targeted messages to directly control the drive. The latter is used to implement Explicit Messaging.

Note that with EtherNet/IP, all data direction notation assumes the point of view of the network. In this way, data sent by the drive to the controller is referred to as an Input, while data sent by the controller down to the drive is referred to as an Output.

### The Class 1 Connection

Class 1 connections use Connection Points, which can be thought of as addresses with predefined functions. To communicate with an Applied Motion drive using a Class 1 connection, the following connection points are available.

Object ID		Function	Notes
Hex	Decimal		
0x64	100	Input Assembly	Static Assembly Object for monitoring drive status & behavior (see below for details)
0x66	102	Configuration Assembly	Specifies parameters such as packet interval, data length.
0x67	103	Heartbeat Input Only Assembly	Zero-length message that tells the controller the drive is still active.
0x68	104	Heartbeat Listen Only Assembly	Zero-length message that tells the drive the controller is still active.

## Input Assembly (0x64)

This connection point is used to monitor the drive's behavior. The 30 bytes of data sent by the drive are as follows:

Field Descriptor	Length (bytes)
IP Address (Encoded in Internet Format)	4
Status Word	2
Alarm Word	2
Supply Voltage	2
Actual Current	2
Drive Temperature	2
Encoder Position (32-bit signed)	4
Absolute Position (32-bit signed)	4
Actual Velocity	2
Input Status (extended)	2
Input Status (main board)	2
Output Status	2

The data transmitted by the drive is sent in Little Endian format, so it will likely require rearranging before use.

IP addresses said to be stored in "Internet Format" are simply encoded into hexadecimal notation and rearranged into Little Endian format. Each octet has a value from 0-255, and can be represented by a single byte.

*Standard IP address:* 192.168.0.40

*Convert to Hexadecimal:*

192	= 0xC0
168	= 0xA8
0	= 0x00
40	= 0x28

*Rearrange into Little Endian Format:* C0 A8 00 28 -> 28 00 A8 C0

*Converted IP address:* 192.168.0.40 -> 0x2800A8C0

Note that all numbers are sent in Little Endian format, so the process for converting is the same for each piece of data.

Thus, an example message might be organized as follows:

Raw: E0032800A8C019000000E90100003802BAFCFFFC72A0600C3FFFF40000F0F00

Grouped: [E003] [2800A8C0] [1900] [0000] [E901] [0000] [3802] [BAFCFFFF] [C72A0600] [C3FF] [FF40] [000F] [0F00]

The data should be decoded as follows. Where possible, the values have been converted to human-readable units. Please refer to the appropriate command page for further information. Note that Encoder Position, Absolute Position and Velocity are signed integers, and negative values will be represented in 2's complement form.

Sequence Number:	0xE003		
IP Address:	0x2800A8C0	= 0xC0A80028	= 192.168.0.40
Status (see SC command):	0x1900	= 0x0019	= 0000 0000 0001 1001
Alarm (see AL command):	0x0000		
Voltage:	0xE901	= 0x01E9	= 489 (48.9 V)
Current (see IC command):	0x0000		
Temp (see IT0 command):	0x3802	= 0x238	= 568 (56.8 degrees C)
Encoder Position (see EP command):	0xBAFCFFFF	= 0xFFFFCBA	= -838
Absolute Position (see SP command):	0xC72A0600	= 0x00062AC7	= 404167
Velocity (see IV command):	0XC3FF	= 0xFFC3	= -61
Extended Inputs (see IS command):	0xFF40	= 0x40FF	
Main Board Inputs: (see ISX command):	0x000F	= 0x0F00	
Outputs (see IO command):	0x0F00	= 0x000F	

### Configuration Assembly (0x66)

This connection point is used by the EtherNet/IP protocol to configure various parameters including the Receive Packet Interval (RPI), data size, etc. It must be specified by the user.

### Heartbeat Input Only Assembly (0x67)

This connection point represents a zero-length assembly object whose purpose is not to send data, but rather to simply inform the controller that the drive is still active and producing data.

### Heartbeat Listen Only Assembly (0x68)

This connection point represents a zero-length assembly object whose purpose is not to send data, but rather to simply inform the drive that the controller is still active and receiving data.

## Explicit Messaging

The AMP EtherNet/IP implementation allows for Explicit Messaging using either a Class 3 connection or the Unconnected Message Manager (UCMM). The service code of this custom profile is 0x3C and the class code is 0x64.

In addition to the custom profile, the following standard objects and services are implemented:

- Message Router Object (Volume 1, Section 5-3)
- Connection Manager (Volume 1, Section 5-7)
- Connection Configuration (Volume 1, Section 5-50)
- Port (Volume 1, Section 3-7)
- Ethernet Link Object (Volume 2, Chapter 5)
- TCP/IP Object (Volume 2, Chapter 5)
- Assembly (Volume 1, Section 5-37)
- CIP Sync Object (Volume 1, Section 5-47.7)

Documentation can be found in the following ODVA specifications (specific sections are noted above next to each object name):

*Volume One: Common Industrial Protocol (CIP™), edition 3.8*

*Volume Two: EtherNet/IP™ Adaptation of CIP, edition 1.9*

## Services

Point of Interest	
To check the drive's profile code and ARM firmware version, use the standard "Get Attribute Single" service with the following parameters:	
Service	0x0E
Class	0x64
Instance	0x00
Attribute	0x08
To communicate with the drive via Explicit Messages, use the Vendor-Specific profile service with the following parameters:	
Message Type	CIP Generic
Service Type	Custom
Service	0x3C
Class	0x64
Instance	0x01
Attribute	0x01

Name	Service	Class	Instance	Attribute
Profile Code & ARM Firmware Version Example response message: 00.75.00.07.41.5F.00.01.03.4A  0x00 = ARM (Ethernet board) firmware major revision, most significant byte 0x75 = ARM (Ethernet board) firmware major revision, least significant byte 0x00 = ARM (Ethernet board) firmware minor revision, most significant byte 0x07 = ARM (Ethernet board) firmware minor revision, least significant byte 0x41 = ASCII 'A', the profile code 0x5F = 95, Model Number (see table below) 0x00 = Sub-model Number (see table below) 0x01 = 1, Drive firmware major revision number (1.xx) 0x03 = 3, Drive firmware minor revision number (x.03) 0x4A = ASCII 'J', Drive firmware revision letter (x.xxJ)  ARM firmware : [major rev] . [minor rev] = [0x0075] . [0x0007] = 117.07	0x0E  ("Get Attribute Single")	0x64	0x00	0x01

Drive Model Number Identification Table					
Model ID Hex [Dec]	Sub-Model ID Hex [Dec]	Drive Model Number	Model ID Hex [Dec]	Sub-Model ID Hex [Dec]	Drive Model Number
0x0F [15]	--	SV7-IP	0X32 [50]	0x0C [12]	STM23Q-3EE
0x11 [17]	--	ST5-IP	0x53 [83]	--	STAC5-IP
0x13 [19]	--	ST10-IP	0x59 [89]	--	STAC5-IP-220
0X32 [50]	0x09 [9]	STM23Q-2EN	0x5F [95]	--	SVAC3-IP
0X32 [50]	0x0A [10]	STM23Q-2EE	0x65 [101]	--	SVAC3-IP-220
0X32 [50]	0x0B [11]	STM23Q-3EN			

Vendor-Specific Device Profile A	0x3C	0x64	0x01	0x01
----------------------------------	------	------	------	------

## Explicit Message Types

Two types of explicit messages can be sent to Applied Motion EtherNet/IP drives. Type 1 messages include most of the buffered SCL and Q commands. However, unlike SCL and Q commands that are sent over RS-232, RS-485 and standard Ethernet, Type 1 messages do not support queries. “Immediate” SCL commands cannot be encapsuated in Type 1 messages.

Type 2 messages provide additional functionality not available with Type 1 messages, including the ability to read back settings and registers. Both types can be sent over a Class 3 connection, or they can be sent to the Unconnected Message Manager (UCMM).

Both command message types result in a response message even when no data is requested.

*All numerical values are in two's complement. Integers are sent big endian (most significant byte first).*

*For detailed SCL and Q command descriptions, please see the main section of this manual. When reading the command descriptions in the main part of this manual, please be advised that the EtherNet/IP encapsulation often requires that different units, and a different range of acceptable values, be used.*

## Type 1 Message Format

See Table 1 for the complete list of commands. The response message will always echo back the opcode and register code (if present). Also contained in the response message is the drive's status code, a bit pattern that indicates useful information such as whether there is a fault or if the motor is in motion. For more information, please see the section on the SC command earlier in this manual.

*Note: All numerical values are in two's complement. Integers are sent big endian (most significant byte first).*

### Command Message Format:

	Bit 7	Bit 6	Bit 5	Bit 4	Bit 3	Bit 2	Bit 1	Bit 0
B0	Reserved = 0	Reserved = 0	Reserved = 0	Reserved = 0	Reserved = 0	Reserved = 0	Reserved = 0	Reserved = 0
B1	Command Axis Number = 0x0			Command Message Type = 0x1				
B2	Register, I/O or other code here for some commands (see Table 1, page 275). 0 for all others.							
B3	Opcode							
B4	Parameter1							
B5	Parameter2							
B6	Parameter3							
B7	Parameter4							

### Response Message Format:

	Bit 7	Bit 6	Bit 5	Bit 4	Bit 3	Bit 2	Bit 1	Bit 0
B0	Reserved = 0	Reserved = 0	Reserved = 0	Reserved = 0	Reserved = 0	Reserved = 0	Reserved = 0	Reserved = 0
B1	Response Axis Number = 0x0			Response Message Type = 0x1				
B2	Register code for commands QR, RR, RW and RX, 0 for all others							
B3	Opcode							
B4	Status Code MSB							
B5	Status Code LSB							
B6	Unused = 0							

B7	Unused = 0
----	------------

## Type 1 Message Examples

### Example 1: SCL commands required for Point to Point move

**AC100** set acceleration rate to 100 rev/sec/sec (6000 rpm/sec)

opcode 0x001E from Table 1

operand 0x258 units are 10 rpm/sec, so 6000 rpm/sec is represented by 600 decimal = 258 hex

Type 1 Command Message Payload		
byte 0	0	reserved
byte 1	1	message type
byte 2	0	unused
byte 3	1E	opcode
byte 4	0	unused
byte 5	0	unused
byte 6	2	operand MSB
byte 7	58	operand LSB

Type 1 Response Message Payload		
byte 0	0	reserved
byte 1	1	message type
byte 2	0	unused
byte 3	1E	opcode
byte 4	?	Status Code MSB
byte 5	?	Status Code LSB
byte 6	0	not used
byte 7	0	not used

**DE100** set deceleration rate to 100 rev/sec/sec (6000 rpm/sec)

opcode 0x001F from Table 1

operand 0x258 units are 10 rpm/sec, so 6000/sec is represented by 600 decimal = 258 hex

Type 1 Command Message Payload		
byte 0	0	reserved
byte 1	1	message type
byte 2	0	unused
byte 3	1F	opcode
byte 4	0	unused
byte 5	0	unused
byte 6	2	operand MSB
byte 7	58	operand LSB

Type 1 Response Message Payload		
byte 0	0	reserved
byte 1	1	message type
byte 2	0	unused
byte 3	1F	opcode
byte 4	?	Status Code MSB
byte 5	?	Status Code LSB
byte 6	0	not used
byte 7	0	not used

**VE5** set velocity to 5 rev/sec (300 rpm)

opcode 0x001D from Table 1

operand 0x4B0 units are 0.25 rpm, so 300 rpm is represented by 1200 decimal = 4B0 hex

Type 1 Command Message Payload		
byte 0	0	reserved
byte 1	1	message type
byte 2	0	unused
byte 3	1D	opcode
byte 4	0	unused
byte 5	0	unused
byte 6	4	operand MSB
byte 7	B0	operand LSB

Type 1 Response Message Payload		
byte 0	0	reserved
byte 1	1	message type
byte 2	0	unused
byte 3	1D	opcode
byte 4	?	Status Code MSB
byte 5	?	Status Code LSB
byte 6	0	not used
byte 7	0	not used

**DI100000** set move distance to 100,000 steps

opcode 0x00B6 from Table 1

operand 0x186A0 units are steps, so 100000 is represented by 186A0 hex

Type 1 Command Message Payload		
byte 0	0	reserved
byte 1	1	message type
byte 2	0	not used
byte 3	B6	opcode
byte 4	0	not used
byte 5	1	operand MSB
byte 6	86	operand 2nd LSB
byte 7	A0	operand LSB

Type 1 Response Message Payload		
byte 0	0	reserved
byte 1	1	message type
byte 2	0	not used
byte 3	B6	opcode
byte 4	?	Status Code MSB
byte 5	?	Status Code LSB
byte 6	0	not used
byte 7	0	not used

**FL** start the “feed to length” move

opcode 0x0066 from Table 1

operand 0 no operand

Type 1 Command Message Payload		
byte 0	0	reserved
byte 1	1	message type
byte 2	0	unused
byte 3	66	opcode
byte 4	0	not used
byte 5	0	not used
byte 6	0	not used
byte 7	0	not used

Type 1 Response Message Payload		
byte 0	0	reserved
byte 1	1	message type
byte 2	0	unused
byte 3	66	opcode
byte 4	?	Status Code MSB
byte 5	?	Status Code LSB
byte 6	0	not used
byte 7	0	not used

## Example 2: setting an output

**SO2L** set output 2 low (closed)

opcode 0x008B from Table 1

operand 0x4CB2 LSB is “2” = 0xB2. MSB is “L” = 0x4C (see IO Encoding Table)



Type 1 Command Message Payload		
byte 0	0	reserved
byte 1	1	message type
byte 2	0	not used
byte 3	8B	opcode
byte 4	0	not used
byte 5	0	not used
byte 6	4C	operand MSB
byte 7	B2	operand LSB

Type 1 Response Message Payload		
byte 0	0	reserved
byte 1	1	message type
byte 2	0	not used
byte 3	8B	opcode
byte 4	?	Status Code MSB
byte 5	?	Status Code LSB
byte 6	0	not used
byte 7	0	not used

### Example 3: enabling the motor

**ME** motor enable  
opcode 0x009F from Table 1  
operand 0 no operand

Type 1 Command Message Payload		
byte 0	0	reserved
byte 1	1	message type
byte 2	0	unused
byte 3	9F	opcode
byte 4	0	not used
byte 5	0	not used
byte 6	0	not used
byte 7	0	not used

Type 1 Response Message Payload		
byte 0	0	reserved
byte 1	1	message type
byte 2	0	unused
byte 3	9F	opcode
byte 4	?	Status Code MSB
byte 5	?	Status Code LSB
byte 6	0	not used
byte 7	0	not used

### Example 4: SCL commands required for Feed to Sensor move

**AC200** set acceleration rate to 200 rev/sec/sec (12000 rpm/sec)  
opcode 0x001E from Table 1  
operand 0x4B0 units are 10 rpm/sec, so 12000 rpm/sec is represented by 1200 decimal = 4B0 hex

Type 1 Command Message Payload		
byte 0	0	reserved
byte 1	1	message type
byte 2	0	unused
byte 3	1E	opcode
byte 4	0	unused
byte 5	0	unused
byte 6	4	operand MSB
byte 7	B0	operand LSB

Type 1 Response Message Payload		
byte 0	0	reserved
byte 1	1	message type
byte 2	0	unused
byte 3	1E	opcode
byte 4	?	Status Code MSB
byte 5	?	Status Code LSB
byte 6	0	not used
byte 7	0	not used

**DE150** set deceleration rate to 150 rev/sec/sec (9000 rpm/sec)  
opcode 0x001F from Table 1

operand 0x384 units are 10 rpm/sec, so 9000/sec is represented by 900 decimal = 384 hex

Type 1 Command Message Payload		
byte 0	0	reserved
byte 1	1	message type
byte 2	0	unused
byte 3	1F	opcode
byte 4	0	unused
byte 5	0	unused
byte 6	3	operand MSB
byte 7	84	operand LSB

Type 1 Response Message Payload		
byte 0	0	reserved
byte 1	1	message type
byte 2	0	unused
byte 3	1F	opcode
byte 4	?	Status Code MSB
byte 5	?	Status Code LSB
byte 6	0	not used
byte 7	0	not used

**VE3** set velocity to 3 rev/sec (180 rpm)

opcode 0x001D from Table 1

operand 0x2D0 units are 0.25 rpm, so 180 rpm is represented by 720 decimal = 2D0 hex

Type 1 Command Message Payload		
byte 0	0	reserved
byte 1	1	message type
byte 2	0	unused
byte 3	1D	opcode
byte 4	0	unused
byte 5	0	unused
byte 6	2	operand MSB
byte 7	D0	operand LSB

Type 1 Response Message Payload		
byte 0	0	reserved
byte 1	1	message type
byte 2	0	unused
byte 3	1D	opcode
byte 4	?	Status Code MSB
byte 5	?	Status Code LSB
byte 6	0	not used
byte 7	0	not used

**DI5000** set move distance to 5,000 steps (this is the distance beyond the sensor where motor will stop)

opcode 0x00B6 from Table 1

operand 0x1388 units are steps, so 5000 is represented by 1388 hex

Type 1 Command Message Payload		
byte 0	0	reserved
byte 1	1	message type
byte 2	0	unused
byte 3	B6	opcode
byte 4	0	operand MSB
byte 5	0	operand 2nd MSB
byte 6	13	operand 2nd LSB
byte 7	88	operand LSB

Type 1 Response Message Payload		
byte 0	0	reserved
byte 1	1	message type
byte 2	0	unused
byte 3	B6	opcode
byte 4	?	Status Code MSB
byte 5	?	Status Code LSB
byte 6	0	not used
byte 7	0	not used

**FS2R** start the “feed to sensor” move, stop 5000 steps after input 2 rising edge

opcode 0x006B from Table 1

operand 0x52B2 LSB is “2” = 0xB2. MSB is “R” = 0x52 (see IO Encoding Table)

Type 1 Command Message Payload		
byte 0	0	reserved
byte 1	1	message type
byte 2	0	unused
byte 3	6B	opcode
byte 4	0	not used
byte 5	0	not used
byte 6	52	condition (R)
byte 7	B2	ionum (2)

Type 1 Response Message Payload		
byte 0	0	reserved
byte 1	1	message type
byte 2	0	unused
byte 3	6B	opcode
byte 4	?	Status Code MSB
byte 5	?	Status Code LSB
byte 6	0	not used
byte 7	0	not used

## Type 2 Message Format

Message Type 2 commands provide functionality that is not available with Type 1 commands. This is the only way to read back information from the drive. All Type 2 commands require an 8 bit opcode and an 8 bit operand. Return values include a 16 or 32 bit response, as appropriate.

The response message will always echo back the opcode and operand from the command message. Also contained in the response message is the drive's status code, unless other information is requested (e.g. parameter read command). The status code is a bit pattern that indicates useful information such as whether there is a fault or if the motor is in motion. For more information, please see the section on the SC command earlier in this manual.

### Command Message Format:

	Bit 7	Bit 6	Bit 5	Bit 4	Bit 3	Bit 2	Bit 1	Bit 0
B0	Reserved = 0	Reserved = 0	Reserved = 0	Reserved = 0	Reserved = 0	Reserved = 0	Reserved = 0	Reserved = 0
B1	Command Axis Number = 0x0			Command Message Type = 0x2				
B2	Opcode (see Table 2)							
B3	Operand (see Table 2)							
B4	Data MSB							
B5	Data LSB [Data 2nd MSB for opcode 0x9E]							
B6	Unused = 0 [Data 2nd LSB for opcode 0x9E]							
B7	Unused = 0 [Data LSB for opcode 0x9E]							

### Response Message Format:

	Bit 7	Bit 6	Bit 5	Bit 4	Bit 3	Bit 2	Bit 1	Bit 0
B0	Reserved = 0	Reserved = 0	Reserved = 0	Reserved = 0	Reserved = 0	Reserved = 0	Reserved = 0	Reserved = 0
B1	Response Axis Number = 0x0			Response Message Type = 0x2				
B2	Opcode (see Table 2)							
B3	Operand (see Table 2)							
B4	Status MSB [Data MSB for opcodes 0x84, 0x88, 0x89, 0x9F]							
B5	Status LSB [Data LSB for opcodes 0x84, 0x88, 0x89] [Data 2nd MSB for opcode 0x9F]							
B6	Unused = 0 [Data 2nd LSB for opcode 0x9F]							
B7	Unused = 0 [Data LSB for opcode 0x9F]							

## Type 2 Message Examples

### Example 1: parameter write

**AC100** set acceleration rate to 100 rev/sec/sec (6000 rpm/sec)

opcode 0x83 parameter write, from Table 2

operand 0x1E from Table 3

data 0x258 units are 10 rpm/sec, so 6000/sec is represented by 600 decimal = 258 hex

Type 2 Command Message Payload		
byte 0	0	reserved
byte 1	2	message type
byte 2	83	opcode
byte 3	1E	operand
byte 4	2	data MSB
byte 5	58	data LSB
byte 6	0	not used
byte 7	0	not used

Type 2 Response Message Payload		
byte 0	0	reserved
byte 1	2	message type
byte 2	83	opcode
byte 3	1E	operand
byte 4	?	Status Code MSB
byte 5	?	Status Code LSB
byte 6	0	not used
byte 7	0	not used

### Example 2: parameter read

**AC** read back the acceleration rate

opcode 0x84 parameter read, from Table 2

operand 0x1E from Table 3

return value 0x258 units are 10 rpm/sec, so 6000/sec is represented by 600 decimal = 258 hex

Type 2 Command Message Payload		
byte 0	0	reserved
byte 1	2	message type
byte 2	84	opcode
byte 3	1E	operand
byte 4	0	not used
byte 5	0	not used
byte 6	0	not used
byte 7	0	not used

Type 2 Response Message Payload		
byte 0	0	reserved
byte 1	2	message type
byte 2	84	opcode
byte 3	1E	operand
byte 4	2	read data MSB
byte 5	58	read data LSB
byte 6	0	not used
byte 7	0	not used

**Example 3: read absolute position**

opcode 0x88 read 32 bit abs posn/enc posn, from Table 2  
 operand 1 from Table 2, indicates abs posn  
 return value 0x87654321

Type 2 Command Message Payload		
byte 0	0	reserved
byte 1	2	message type
byte 2	88	opcode
byte 3	1	operand
byte 4	0	not used
byte 5	0	not used
byte 6	0	not used
byte 7	0	not used

Type 2 Response Message Payload		
byte 0	0	reserved
byte 1	2	message type
byte 2	88	opcode
byte 3	1	operand
byte 4	87	read data MSB
byte 5	65	read data 2nd MSB
byte 6	43	read data 2nd LSB
byte 7	21	read data LSB

**Example 4: read encoder position**

opcode 0x88 read 32 bit abs posn/enc posn, from Table 2  
 operand 0 from Table 2, indicates enc posn  
 return value 0x12345678

Type 2 Command Message Payload		
byte 0	0	reserved
byte 1	2	message type
byte 2	88	opcode
byte 3	0	operand
byte 4	0	not used
byte 5	0	not used
byte 6	0	not used
byte 7	0	not used

Type 2 Response Message Payload		
byte 0	0	reserved
byte 1	2	message type
byte 2	88	opcode
byte 3	0	operand
byte 4	12	read data MSB
byte 5	34	read data 2nd MSB
byte 6	56	read data 2nd LSB
byte 7	78	read data LSB

**Example 5: read Q user register 3**

opcode 0x9F read 32 bit Q register, from Table 2  
 operand 0x33 from Reg Code Table, indicates register '3'  
 return value 0x12345678

Type 2 Command Message Payload		
byte 0	0	reserved
byte 1	2	message type
byte 2	9F	opcode
byte 3	33	operand
byte 4	0	not used
byte 5	0	not used
byte 6	0	not used
byte 7	0	not used

Type 2 Response Message Payload		
byte 0	0	reserved
byte 1	2	message type
byte 2	9F	opcode
byte 3	33	operand
byte 4	12	read data MSB
byte 5	34	read data 2nd MSB
byte 6	56	read data 2nd LSB
byte 7	78	read data LSB

**Example 6: read Q register D**

opcode 0x9F read 32 bit Q register, from Table 2  
 operand 0x44 from Reg Code Table, indicates register 'D'  
 return value 0x12345678

Type 2 Command Message Payload		
byte 0	0	reserved
byte 1	2	message type
byte 2	9F	opcode
byte 3	44	operand
byte 4	0	not used
byte 5	0	not used
byte 6	0	not used
byte 7	0	not used

Type 2 Response Message Payload		
byte 0	0	reserved
byte 1	2	message type
byte 2	9F	opcode
byte 3	44	operand
byte 4	12	read data MSB
byte 5	34	read data 2nd MSB
byte 6	56	read data 2nd LSB
byte 7	78	read data LSB

**Example 7: write Q register D**

opcode 0x9E read 32 bit Q register, from Table 2  
 operand 0x44 from Reg Code Table, indicates register 'D'  
 data 0x12345678

Type 2 Command Message Payload		
byte 0	0	reserved
byte 1	2	message type
byte 2	9E	opcode
byte 3	44	operand
byte 4	12	data MSB
byte 5	34	data 2nd MSB
byte 6	56	data 2nd LSB
byte 7	78	data LSB

Type 2 Response Message Payload		
byte 0	0	reserved
byte 1	2	message type
byte 2	9E	opcode
byte 3	44	operand
byte 4	?	status code MSB
byte 5	?	status code LSB
byte 6	0	not used
byte 7	0	not used

**Example 8: Disable IEEE-1588 protocol (for Class 1 connections)**

opcode 0xFE IEEE-1588 control, from Table 2  
 operand 0x1 Disable IEEE-1588 protocol. (0x0 will enable IEEE-1588)  
 data 0x0

Type 2 Command Message Payload		
byte 0	0	reserved
byte 1	2	message type
byte 2	FE	opcode
byte 3	1	operand
byte 4	0	not used
byte 5	0	not used
byte 6	0	not used
byte 7	0	not used

Type 2 Response Message Payload		
byte 0	0	reserved
byte 1	2	message type
byte 2	FE	opcode
byte 3	0	operand
byte 4	?	status code MSB
byte 5	?	status code LSB
byte 6	0	not used
byte 7	0	not used

**Table 1: Message Type 1 Command List**

For detailed SCL and Q command descriptions, please see the main section of this manual. When reading the command descriptions in the main part of this manual, please be advised that the EtherNet/IP encapsulation often requires that different units, and a different range of acceptable values, be used.

Command	Description	opcode (hex)	Reg code	Parameter 1	Parameter 2	Parameter 3	Parameter 4	Range ST5 / ST10 / STAC5	Units
<b>Motion Commands</b>									
AC	P_TO_P_ACCEL,	1E	0			accel rate		1..32000	10 rpm/sec
AM	MAX_ACCEL,	16	0			accel rate		1..32000	10 rpm/sec
AX	ALARM_RESET	BA	0						
CJ	START_JOGGING	96	0						
DC	SET_CHNG_DISTANCE	B7	0	32 bit distance or position				+/-2,147,483,647	steps
DE	P_TO_P_DECEL,	1F	0			decel rate		1..32000	10 rpm/sec
DI	SET_REL_DISTANCE	B6	0	32 bit distance or position				+/-2,147,483,647	steps
EF	ENCODER_FUNCTION	D6	0			function		0,1,2 or 6	0 = Encoder function off 1 = Stall Detection 2 = Stall Prevention 6 = Stall prevention w/ time-out
EG	Steps/rev / 2	26	0			steps/rev		100..25600	steps/rev divided by 2
EP	ENCODER_POSITION	98	0	32 bit encoder position				+/-2,147,483,647	counts
FC	P_TO_P_CHANGE	6D	0						
FD	feed to double sensor	69	0	cond 2	io2	cond 1	io1	ST: X0..X8, L/H/F/R STAC5: X0..X4, 1..8. L/H/F/R	see IO Encoding Table
FE	FOLLOW ENCODER	CC	0			cond	io	ST: X0..X8, L/H/F/R STAC5: X0..X4, 1..8. L/H/F/R	see IO Encoding Table
FL	feed to length (relative move)	66	0						
FM	Feed to Sensor with mask distance	6A	0			cond	io	ST: X0..X8, L/H/F/R STAC5: X0..X4, 1..8. L/H/F/R	see IO Encoding Table
FO	feed and set output	68	0			cond	io	ST: Y1..Y4, L or H STAC5: 1..4, Y1,Y2. L or H	see IO Encoding Table
FP	feed to position (absolute move)	67	0						
FS	Feed to Sensor	6B	0			cond	io	ST: X0..X8, L/H/F/R STAC5: X0..X4, 1..8. L/H/F/R	see IO Encoding Table
FY	Feed to Sensor with safety distance	6C	0			cond	io	ST: X0..X8, L/H/F/R STAC5: X0..X4, 1..8. L/H/F/R	see IO Encoding Table



Command	Description	opcode (hex)	Reg code	Parameter 1	Parameter 2	Parameter 3	Parameter 4	Range ST5 / ST10 / STAC5	Units
HW	Hand wheel	AB	0			cond	io	ST: X0..X8, L/H/F/R STAC5: X0..X4, 1..8. L/H/F/R	see IO Encoding Table
JA	VM_ACCEL,	1B	0			jog accel rate		1..32000	10 rpm/sec
JD	JOG_DISABLE	A3	0						
JE	JOG_ENABLE	A2	0			direction		1=cw enable, 2=ccw enable, 3=both	
JL	VM_DECEL,	1C	0			jog decel rate		1..32000	10 rpm/sec
JS	VM_VELOCITY,	1A	0			jog speed		0..32000	.25 rpm
MD	MOTOR_DISABLE	9E	0						
ME	MOTOR_ENABLE	9F	0						
MT	Multi Tasking	A9	0			0	0 or 1	0 or 1	1=on, 0=off
SH	SEEK_HOME, ionum+cond	6E	0			cond	io	ST: X0..X8, L/H/F/R STAC5: X0..X4, 1..8. L/H/F/R	see IO Encoding Table
SM	STOP_MOVING	B5	0			decel code		D (DE rate) or M (AM rate)	'D' or 'M'
SP	SET_ABS_POSITION	A5	0	32 bit abs position				+/-2,147,483,647	steps
VC	CHANGE_VELOCITY,	4A	0			speed		1..32000	.25 rpm
VE	P_TO_P_VELOCITY,	1D	0			speed		1..32000	.25 rpm
WI	Wait for Input	70	0			cond	io	ST: X0..X8, L/H/F/R STAC5: X0..X4, 1..8. L/H/F/R	see IO Encoding Table
WM	WAIT_ON_MOVE	BC	0						
WP	WAIT_ON_POSITION	D0	0						
<b>Configuration Commands</b>									
--	RESTORE_DEFAULTS	A6							
AD	Analog Deadband	D2	0			dead band		0..255	millivolts
AS	Analog Scaling	D1	0			scale code		0..7	0 = single-ended +/- 10 volts 1 = single-ended 0 - 10 volts 2 = single-ended +/- 5 volts 3 = single-ended 0 - 5 volts 4 = differential +/- 10 volts 5 = differential 0 - 10 volts 6 = differential +/- 5 volts 7 = differential 0 - 5 volts
BD	BRAKE RELEASE DELAY	40	0			brake release delay		1..32000	msec
BE	BRAKE ENGAGE DELAY	41	0			brake engage delay		1..32000	msec
CA	ACCEL_CURRENT,	61	0			accel current		not supported	10 rpm/sec

Command	Description	opcode (hex)	Reg code	Parameter 1	Parameter 2	Parameter 3	Parameter 4	Range ST5 / ST10 / STAC5	Units
CC	Running CURRENT	18	0			motor current when running		500 / 1000 / 500	.01 amps
CD	IDLE_CURRENT_DELAY,	4F	0			delay time		1..32000	msec
CI	IDLE CURRENT	19	0			motor current when idle		500 / 1000 / 500	.01 amps
CM	CONTROL_MODE,	10	0			mode code		7, 10..18, 21, 22	
EF	Encoder Function	D6	0			function code		0,1,2 or 6	0 = Encoder function off 1 = Stall detection 2 = Stall prevention 6 = Stall prevention w/ time-out
ER	ENCODER_RESOLUTION,	20	0			encoder line count		50..32000	lines/rev (counts/rev/4)
FI	Filter Input	C0	io			filter value		0..32767	CPU cycles
FX	Filter Select Inputs	D3	0			input bank		0 or 1	1=IN/OUT1, 0=IN/OUT2
HG	harmonic smoothing gain	4	0			gain		0..32000	
HP	harmonic smoothing phase	5	0			phase		+/-255	
PA	PU_ACCEL_CURRENT	D7	0			current		STM only	.01 amps
PF	POSITION_FAULT,	21	0			posn fault limit		1..32000	encoder counts
PM	OPERATION_MODE,	44	0			mode code		2 or 7	
SF	STEP_FILTER_FREQUENCY,	6	0			freq		100..25000	0.1 Hz
<b>I/O Commands</b>									
AD	ANALOG_DEADBAND	D2	0			deadband		0..255	mV
AF	ANALOG_FILTER_GAIN,	4C	0			freq		0..32000	Filter value = 72090 / [ (1400 / Hz) + 2.2 ]. 0=no filter
AG	ANALOG_VELOCITY_GAIN,	3B	0			speed at full scale		+/-32000	.25 rpm
AI	ALARM_RESET INPUT	46	0			state		1..3	
AO	FAULT OUTPUT	47	0			state		1..3	
AP	ANALOG_POSITION_GAIN,	4B	0			posn at full scale		1..32000	steps
AS	ANALOG_SCALING	D1	0			input range		0..7	0 = single-ended +/- 10 volts 1 = single-ended 0 - 10 volts 2 = single-ended +/- 5 volts 3 = single-ended 0 - 5 volts 4 = differential +/- 10 volts 5 = differential 0 - 10 volts 6 = differential +/- 5 volts 7 = differential 0 - 5 volts

Command	Description	opcode (hex)	Reg code	Parameter 1	Parameter 2	Parameter 3	Parameter 4	Range ST5 / ST10 / STAC5	Units
AT	ANALOG_THRESHOLD,	4D	0			threshold voltage		+/-32767	ADC Counts 32767 = +10 volts -32767 = -10 volts
AV	ANALOG_OFFSET,	3C	0			offset		+/-32000	ADC counts
AZ	AUTO_OFFSET	A1	0						
BD	BRAKE RELEASE DELAY	40	0			brake release delay		1..32000	msec
BE	BRAKE ENGAGE DELAY	41	0			brake engage delay		1..32000	msec
BO	BRAKE_OUTPUT,	48	0			state		1..3	
DL	DEFINE_LIMITS,	42	0			state		1..3	
FI	FILTER_INPUT	C0	io			filter value		0..32767	CPU cycles
FX	FILTER_SELECT_INPUTS	D3	0			input bank		0=extended, 1 = main board	
JD	JOG_DISABLE	A3	0						
JE	JOG_ENABLE	A2	0			direction		1=cw enable, 2=ccw enable, 3=both	
MO	MOVE_OUTPUT,	49	0			state		1..3	
OI	ON_INPUT	B9	0			cond	io	ST: X0..X8, L/H/F/R STAC5: X0..X4, 1..8. L/H/F/R	see IO encoding table
SI	ENABLE INPUT	45	0			state		1..3	
SO	Set Output	8B	0			cond	io	ST: Y1..Y4, L or H STAC5: 1..4, Y1,Y2. L or H	see IO Encoding Table
TI	Test Input	A8	0			cond	io	ST: X0..X8, L/H/F/R STAC5: X0..X4, 1..8. L/H/F/R	see IO Encoding Table
WI	Wait for Input	70	0			cond	io	ST: X0..X8, L/H/F/R STAC5: X0..X4, 1..8. L/H/F/R	see IO Encoding Table
<b>Register Commands</b>									
CR	Compare Registers	BE	0			reg 1	reg 2	a..z or A..Z or 0..9	see register code table
R+	Register add	B2	2B			reg 1	reg 2	a..z or A..Z or 0..9	see register code table
R-	Register subtract	B2	2D			reg 1	reg 2	a..z or A..Z or 0..9	see register code table
R*	Register multiply	B2	2A			reg 1	reg 2	a..z or A..Z or 0..9	see register code table
R/	Register divide	B2	2F			reg 1	reg 2	a..z or A..Z or 0..9	see register code table
R&	Register and	B2	26			reg 1	reg 2	a..z or A..Z or 0..9	see register code table
R	Register or	B2	7C			reg 1	reg 2	a..z or A..Z or 0..9	see register code table

Command	Description	opcode (hex)	Reg code	Parameter 1	Parameter 2	Parameter 3	Parameter 4	Range ST5 / ST10 / STAC5	Units
RC	Register Counter	BB	0			cond	io	ST: X0..X8, L/H/F/R STAC5: X0..X4, 1..8. L/H/F/R	see IO Encoding Table
RD	Register Decrement	AF	0			reg code		A..Z or 0..9	see register code table
RI	Register Increment	B0	0			reg code		A..Z or 0..9	see register code table
RM	REGISTER MOVE	B1	0			dest reg	src reg	source: a..z or A..Z or 0..9. dest: A..Z or 0..9	see register code table
RR	REGISTER_READ from mem	B3	reg			NV mem location		reg: A..Z or 0..9. memory location: 1..100	see register code table
RW	REGISTER_WRITE to mem	B4	reg			NV mem location		reg: a..z or A..Z or 0..9. memory location: 1..100	see register code table
RX	REGISTER_LOAD	AE	reg	value (16 or 32 bits, depending on register type)				reg: A..Z or 0..9 value: +/- 2147483647 (long data registers) +/- 32767 (short data registers)	see register code table
TR	Test Register Immediate	AC	reg	value (16 or 32 bits, depending on register type)				reg: a..z or A..Z or 0..9 value: +/- 2147483647 (long data registers) +/- 32767 (short data registers)	see register code table
TS	TIME_STAMP	C3	0						
<b>Q Program Commands</b>									
AX	ALARM_RESET	BA	0						
MT	Multi Tasking	A9	0			0	0 or 1	0 or 1	1=on, 0=off
OF	ON_FAULT	B8	0			segment		0..12	
OI	ON_INPUT	B9	0			cond	io	ST: X0..X8, L/H/F/R STAC5: X0..X4, 1..8. L/H/F/R	see IO encoding table
QC	Queue Call	74	0			segment		1..12	
QG	Queue Goto	7E	0			line		1..62	
QJ	Queue Jump	7F	cc			line		line: 1..62	cc (condition code): ASCII T = True F = False P = Positive G = Greater than L = Less than E = Equals U = Unequal Z = Zero
QR	Queue Repeat	79	reg			segment		reg code: 0..9 or A..Z. Segment: 1..12	see register code table

Command	Description	opcode (hex)	Reg code	Parameter 1	Parameter 2	Parameter 3	Parameter 4	Range ST5 / ST10 / STAC5	Units
QX	Queue Load Execute	78	0			segment		1..12	
NO	NO_OP	CE	0						
TI	TEST_INPUT	A8	0			cond	io	ST: X0..X8, L/H/F/R STAC5: X0..X4, 1..8. L/H/F/R	see IO Encoding Table
WD	WAIT_DELAY_REGISTER	BF	reg					a..z or A..Z or 0..9	see register code table
WI	WAIT_ON_INPUT, ionum+cond	70	0			cond	io	ST: X0..X8, L/H/F/R STAC5: X0..X4, 1..8. L/H/F/R	see IO Encoding Table
WM	WAIT_ON_MOVE	BC	0						
WP	WAIT_ON_POSITION	D0	0						
WT	Wait Time	6F	0			delay time		1..32000	.01 seconds

**Table 2: Message Type 2 Commands**

Opcode	Definition	Operand	Action
83	Parameter Write	see Table 3	write a 16 bit parameter to a register. Add 128 (0x80) to operand for non-volatile (flash) write
84	Parameter read	see Table 3	Returns the 16 bit parameter indicated by operand
87	Read alarm code	0	Returns alarm history value indicated by operand
88	Read Encoder/Abs Posn	0	Returns the 32 bit encoder position
		1	Returns the 32 bit absolute position
8B*	Set Output (immediate)	bit 7 state, bits 0-6 output	Set the given output to given state.
8E	Clear Fault (AR)	0	Clear the drive fault. A motor enable must be sent to re-enable the motor
98	Stop Motion, Kill Buffer (SK)	decel rate	stops a move, purge all commands from buffer. 0=use quick decel (AM), 1=use normal decel (DE or JL)
9E**	Write Q Register (RL)	see Reg Encoding table	write a 16 or 32 bit parameter to a Q register (A..Z or 0..9, etc)
9F	Read Q Register (RL)	see Reg Encoding table	read a 16 or 32 bit Q register (a..z, A..Z or 0..9, etc)
A1	Queue Load (QL)	0	load incoming Type 1 commands into Q buffer
A2	Queue Save (QS)	segment number 1..12	saves Q buffer as a Q segment
A3	Stop Motion (ST)	decel rate	stops a move. 0=use quick decel (AM), 1=use normal decel (DE or JL)
FE	IEEE-1588 Control	0	Enables IEEE-1588 protocol, preventing Class 1 connection
		1	Disable IEEE-1588 protocol, allowing Class 1 connection
FF	UDP port reset	0	Opens UDP port 7775 and listens for a new connection
		1	Closes and resets UDP port 7775

\*Type 2 Set Output Immediate (opcode 8B) operand table

Operand	00	01	02	03	04	05	80	81	82	83	84	85
<b>ST</b>	OUT1 high	OUT2 high	OUT3 high	OUT4 high			OUT1 low	OUT2 low	OUT3 low	OUT4 low		
<b>STAC5</b>	Y1 high	Y2 high	OUT1 high	OUT2 high	OUT3 high	OUT4 high	Y1 low	Y2 low	OUT1 low	OUT2 low	OUT3 low	OUT4 low

*\*\*Q register writes are not range checked, so be careful before you write.*

**Table 3: Parameter read/write operands***All values are HEX*

Command	Description	Index	Q Register Char
<b>Read/write</b>			
--	MISC_FLAGS	5B	F
--	ENCODER_ATTEMPTS,	62	
AC	P_TO_P_ACCEL,	1E	A
AF	ANALOG_FILTER_GAIN,	4C	
AG	ANALOG_VELOCITY_GAIN,	3B	H
AI	ALARM_RESET,	46	
AM	MAX_ACCEL,	16	
AO	ALARM_OUTPUT,	47	
AP	ANALOG_POSITION_GAIN,	4B	X
AT	ANALOG_THRESHOLD,	4D	Y
AV	ANALOG_OFFSET,	3C	Z
BD	BRAKE_DELAY,	40	
BE	BRAKE_DELAY_2,	41	
BO	BRAKE_OUTPUT,	48	
CA	ACCEL_CURRENT [STM only]	61	
CC	MAX_CURRENT	18	N
CD	IDLE CURRENT DELAY	4F	
CF	Anti-resonance Frequency	50	
CG	Anti-resonance Gain	51	
CI	IDLE CURRENT	19	O
CM	CONTROL_MODE,	10	
DE	P_TO_P_DECEL,	1F	B
DL	DEFINE_LIMITS,	42	
ED	ENC_DIRECTION,	5F	
EG	Steps/rev divided by 2	26	R
ER	ENCODER_RESOLUTION,	20	
HG	HYPERBOLIC_GAIN,	4	
HP	HYPERBOLIC_PHASE,	5	
JA	VM_ACCEL,	1B	K
JL	VM_DECEL,	1C	L
JS	VM_VELOCITY,	1A	M
MO	MOVE_OUTPUT,	49	
MV	ModelNum:F/W version	1	
PF	POSITION_FAULT,	21	
PM	OPERATION_MODE,	44	
PR	PROTOCOL,	59	
SF	STEP_FILTER_FREQUENCY,	6	

Command	Description	Index	Q Register Char
SI	SERVO_ENABLE,	45	
TD	ACK_DELAY,	5A	
VC	CHANGE_VELOCITY,	4A	U
VE	P_TO_P_VELOCITY,	1D	V
<b>Read Only</b>			
--	DSP firmware letter	8E	
--	Hall Pattern (SV7 only)	8F	
--	Sub Model (STM only)	90	
--	IsServo (ST/SV only: 1=servo, 0=stepper). Can be used to tell if drive is servo or stepper	91	
AL	alarm code	81	f
BS	Buffer Status	94	
EP	encoder count upper	84	
EP	encoder count lower	85	
IA	command voltage (Ain)	83	a
IC	command current	88	c
IO	Output Status (reads back outputs)	95	
IQ	actual current	89	q
IS	IN/OUT 2 input status [STAC5 only, read as "F" on ST]	8D	y
ISX	IN/OUT 1 input status	82	i
IT	drive temp	87	t
IU	supply voltage	86	u
IV	actual speed	8B	v
IV1	target speed	8C	w
IX	position error	8A	x
OP	DriveOptions – bit pattern indicating presence of option boards. Bit 0 = Encoder Bit 1 = RS-485 Bit 2 = CANopen Bit 3 = reserved Bit 4 = Resolver Bit 5 = MCF (encoder in and out – SV7 only) Bit 6 = Ethernet	92	
SC	status word	80	s



## IO Encoding Table

Useful ASCII values for IO commands

On STAC5, inputs X1-X4 and outputs Y1 & Y2 are on the DB15 (IN/OUT 1) connector. Input X0 is the encoder index signal. Inputs 1-8 and outputs 1-4 are on the DB25 (IN/OUT 2) connector.

Character	hex code	Signifies	
		ST5 & ST10	STAC5
X0	0xB0	encoder index signal	encoder index signal
X1 or Y1	0xB1	input X1 or output Y1	input X1 or output Y1
X2 or Y2	0xB2	input X2 or output Y2	input X2 or output Y2
X3 or Y3	0xB3	input X3 or output Y3	input X3
X4 or Y4	0xB4	input X4 or output Y4	input X4
X5	0xB5	input X5	n/a
X6	0xB6	input X6	n/a
X7	0xB7	input X7	n/a
X8	0xB8	input X8	n/a
1	0x31	n/a	input 1 or output 1
2	0x32	n/a	input 2 or output 2
3	0x33	n/a	input 3 or output 3
4	0x34	n/a	input 4 or output 4
5	0x35	n/a	input 5
6	0x36	n/a	input 6
7	0x37	n/a	input 7
8	0x38	n/a	input 8
L	0x4C	low state (closed)	low state (closed)
H	0x48	high state (open)	high state (open)
R	0x52	rising edge	rising edge
F	0x46	falling edge	falling edge

## Register Encoding Table

Register Name	Use	equivalent SCL command	Code	Size	Read Only
0	Accumulator		0x30	long	
1	user defined		0x31	long	
2	user defined		0x32	long	
3	user defined		0x33	long	
4	user defined		0x34	long	
5	user defined		0x35	long	
6	user defined		0x36	long	
7	user defined		0x37	long	
8	user defined		0x38	long	
9	user defined		0x39	long	
:	user defined		0x3A	long	
;	user defined		0x3B	long	
<	user defined		0x3C	long	
=	user defined		0x3D	long	
>	user defined		0x3E	long	
?	user defined		0x3F	long	
@	user defined		0x40	long	
[	user defined		0x5B	long	
\	user defined		0x5C	long	
]	user defined		0x5D	long	
^	user defined		0x5E	long	
_	user defined		0x5F	long	
`	user defined		0x60	long	
a	analog command	IA	0x61	short	yes
b	Q line number		0x62	short	yes
c	current command	IC	0x63	short	yes
d	relative distance	ID	0x64	long	yes
e	encoder position	IE, EP	0x65	long	yes
f	alarm code	AL	0x66	long	yes
g	sensor position		0x67	short	yes
h	condition code		0x68	short	yes
i	X inputs (IN/OUT 1)	ISX	0x69	short	yes
j	analog IN1	IA1	0x6A	short	yes
k	analog IN2	IA2	0x6B	short	yes
l	absolute position		0x6C	long	yes
m	control mode	CM	0x6D	short	yes
n	velocity mode state		0x6E	short	yes
o	point to point state		0x6F	short	yes

Register Name	Use	equivalent SCL command	Code	Size	Read Only
p	Q segment		0x70	short	yes
q	actual current	IQ	0x71	short	yes
r	average regen power		0x72	short	yes
s	status code	SC	0x73	short	yes
t	drive temperature	IT	0x74	short	yes
u	bus voltage	IU	0x75	short	yes
v	actual velocity	IV0	0x76	short	yes
w	target velocity	IV1	0x77	short	yes
x	position error	IX	0x78	long	yes
y	IN/OUT 2 inputs	IS	0x79	short	yes
z	phase error		0x7A	short	yes
A	accel rate	AC	0x41	short	
B	decel rate	DE	0x42	short	
C	change distance	DC	0x43	long	
D	distance	DI	0x44	long	
E	position offset		0x45	long	
F	other (misc) flags		0x46	long	
G	current command	GC	0x47	short	
H	analog velocity gain		0x48	short	
I	input counter		0x49	long	
J	jog speed		0x4A	short	
K	jog accel rate		0x4B	short	
L	jog decel rate		0x4C	short	
M	max velocity	JS	0x4D	short	
N	continuous current	CC	0x4E	short	
O	idle current	CI	0x4F	short	
P	absolute position command		0x50	long	
Q	reserved		0x51		
R	steps/rev	EG	0x52	short	
S	pulse count		0x53	long	
T	total count		0x54	long	
U	change speed	VC	0x55	short	
V	velocity	VE	0x56	short	
W	time stamp		0x57	short	
X	analog position gain	AP	0x58	short	
Y	analog threshold	AT	0x59	short	
Z	analog offset	AV	0x5A	short	

## EtherNet/IP And Q Programs

To provide additional functionality and autonomy, Q programs can be stored in EtherNet/IP drives. These programs can be started and stopped “on demand” using explicit messaging. The *Q Programmer* application is used to compose, download and test Q programs. Please avoid sending EtherNet/IP messages to the drive while the *Q Programmer* software is running.

To start a Q program from an EtherNet/IP message, you must send a Type 1 message with opcode 0x78 (the QX command). You’ll need to specify the Q segment number, as shown in the example. This allows you to store up to 12 Q segments, or subprograms, and operate them independently. Q segments can also call each other once one has been started.

### Example: Starting Q Segment 1

**QX1**      start Q segment 1  
 opcode    0x0078 from Table 1  
 operand   0x1      segment 1 (up to 12 segments are allowed in a Q program)

Type 1 Command Message Payload		
byte 0	0	reserved
byte 1	2	message type
byte 2	0	not used
byte 3	78	operand
byte 4	0	unused
byte 5	0	unused
byte 6	0	unused
byte 7	1	segment number

Type 1 Response Message Payload		
byte 0	0	reserved
byte 1	2	message type
byte 2	0	not used
byte 3	78	operand
byte 4	?	Status Code MSB
byte 5	?	Status Code LSB
byte 6	0	not used
byte 7	0	not used

Once a Q segment has begun, Type 1 messages are no longer permitted, because the CPU is busy executing the commands in the Q segment. To stop a Q program, you must use a Type 2 “SK” message (opcode 98, as shown in the next example). Q programs also stop running if they encounter a blank line in the segment. This makes it possible to launch a segment, have it complete a task, and stop by itself.

### Example: Stopping a Q Program

**SK**      stop the Q program  
 opcode    0x98    from Table 2  
 operand   decel rate (0 = use quick decel rate from AM, 1 = use normal decel rate from DE or JL)

Type 2 Command Message Payload		
byte 0	0	reserved
byte 1	2	message type
byte 2	98	opcode
byte 3	0	operand
byte 4	0	not used
byte 5	0	not used
byte 6	0	not used
byte 7	0	not used

Type 2 Response Message Payload		
byte 0	0	reserved
byte 1	2	message type
byte 2	98	opcode
byte 3	0	operand
byte 4	?	status code MSB
byte 5	?	status code LSB
byte 6	0	not used
byte 7	0	not used

## Communicating with a Q Program While It's Running

You can use Type 2 commands to read and write registers while a Q program is running. The Q program can send information to the host by changing a register that the host is polling. Registers 0 - 9 can be polled using the Type 2 User Register Read command (opcode 9A).

The host can make changes to the Q program operation by writing to parameters that the program uses. For example, you could change the motor speed sending a parameter write message that alters VE (Type 2 message, opcode 83, operand 1D). The speed change will take effect on the next move.

Changes that affect a Q program immediately can be made using the Write Q Register command (message type 2, opcode 9E). For example, if the motor is jogging after having been sent a CJ command, writing to register J will result in an immediate speed change. *Please note that Q register writes are not range checked, so be careful before you write.*

## How to Know if a Q Program Has Stopped

Since a Q program can be launched and allowed to stop itself when it encounters a blank line, you may want to know when it stops. You can do this by polling for the status word and observing bit 14. This bit is a one if the program is executing. To fetch the status word, use the Type 2 Parameter Read command with operand 0x80 as shown below.

### Example: Checking Status While a Q Program is Running

opcode 0x84 parameter read, from Table 2  
operand 0x80 status code, from Table 3

Type 2 Command Message Payload		
byte 0	0	reserved
byte 1	2	message type
byte 2	84	opcode
byte 3	80	operand
byte 4	0	not used
byte 5	0	not used
byte 6	0	not used
byte 7	0	not used

Type 2 Response Message Payload		
byte 0	0	reserved
byte 1	2	message type
byte 2	84	opcode
byte 3	80	operand
byte 4	?	status code MSB
byte 5	?	status code LSB
byte 6	0	not used
byte 7	0	not used

#### Typical return values:

0001 Motor enabled, Q program not running  
4001 Motor enabled, Q program running  
4801 Motor enabled, Q running, Wait Time command executing  
4019 Motor enabled, motor moving, Q running

*For more information about the status code, please read about the SC command in the main part of this manual.*

## Can I Download a Q Program over EtherNet/IP?

The preferred method for creating, downloading and testing Q programs is to use the *Q Programmer* software. Should you prefer to download a program over the EtherNet/IP interface instead, the procedure is as follows:

1. Develop and test your program using *Q Programmer* so that you know the final contents of the Q segments(s) you'll need. Any Type 1 command can be used in a Q program.
2. Encode each command into a Type 1 message, according to Table 1.
3. Issue the QL (Queue Load) Type 2 command (see Table 2).
4. Begin sending the encoded Q commands that you want in this segment. They will be placed into the Q buffer.
5. After sending the entire contents of a segment, issue the Type 2 "QS" command, which instructs the drive to save the Q buffer as a Q segment.
6. Repeat steps 2 - 5 if you have additional Q segments.
7. When you have completed the download process for all segments (steps 1 - 6), upload your program using *Q Programmer* to make sure that there were no mistakes.

## EtherNet/IP on large networks

Once a computer connects to an Applied Motion EtherNet/IP drive with Applied Motion software such as ST Configurator, STAC Configurator or Q Programmer, that connection is maintained until power is cycled. In most cases this will be acceptable because only one computer will ever need to connect to the drive for monitoring or Q program download. In large complex installations however, it may simply not be feasible to cycle power to the machine every time a new technician connects to the drive.

To address this, we have implemented opcode 0xFF. Using an operand of 1 will allow the user to forcibly reset the maintenance port (UDP port 7775), effectively yielding control of the drive. Once reset, the port must be reinitialized, which requires opcode 0xFF to be sent again, this time with an operand of 0. This will instruct the drive to accept a new connection from the next computer that tries to connect using Applied Motion software.

It is important to understand that only one host computer may be connected to the drive at any given time. To change hosts again, simply repeat the sequence.

### Example: Close and reset UDP port for access by another host

opcode 0xFF from Table 2

operand 0x1 Close and reset UDP port 7775.

Type 2 Command Message Payload		
byte 0	0	reserved
byte 1	2	message type
byte 2	FF	opcode
byte 3	0	not used
byte 4	0	not used
byte 5	0	not used
byte 6	0	not used
byte 7	1	operand

Type 2 Response Message Payload		
byte 0	0	reserved
byte 1	2	message type
byte 2	FF	opcode
byte 3	0	not used
byte 4	?	Status Code MSB
byte 5	?	Status Code LSB
byte 6	0	not used
byte 7	0	not used

Remember, this is a two step process. First the port must be closed and reset, as shown above. Once reset, the port must be opened for new connections, which may be accomplished by sending opcode FF again, but this time with an operand of 0.

## CIP General Status Codes

The following table lists the Status Codes that may be present in the General Status Code field of an Error Response message. Note that the Extended Code Field is available for use in further describing any General Status Code. Extended Status Codes are unique to each General Status Code within each object. Each object shall manage the extended status values and value ranges (including vendor specific). All extended status values are reserved unless otherwise indicated within the object definition.

General Status Code (in hex)	Status Name	Description of Status
00	Success	Service was successfully performed by the object specified.
01	Connection failure	A connection related service failed along the connection path.
02	Resource unavailable	Resources needed for the object to perform the requested service were unavailable.
03	Invalid parameter value	See Status Code 0x20, which is the preferred value to use for this condition.
04	Path segment error	The path segment identifier or the segment syntax was not understood by the processing node. Path processing shall stop when a path segment error is encountered.
05	Path destination unknown	The path is referencing an object class, instance or structure element that is not known or is not contained in the processing node. Path processing shall stop when a path destination unknown error is encountered.
06	Partial transfer	Only part of the expected data was transferred.
07	Connection lost	The messaging connection was lost.
08	Service not supported	The requested service was not implemented or was not defined for this Object Class/ Instance.
09	Invalid attribute value	Invalid attribute data detected
0A	Attribute list error	An attribute in the Get_Attribute_List or Set_Attribute_List response has a non-zero status.
0B	Already in requested mode/ state	The object is already in the mode/state being requested by the service.
0C	Object state conflict	The object cannot perform the requested service in its current mode/state.
0D	Object already existst	The requested instance of object to be created already exists.
0E	Attribute not settable	A request to modify a non-modifiable attribute was received.
0F	Privilege violation	A permission/privilege check failed.
10	Device state conflict	The device's current mode/state prohibits the execution of the requested service.
11	Reply data too large	The data to be transmitted in the response buffer is larger than the allocated response buffer.
12	Fragmentation of a primitive value	The service specified an operation that is going to fragment a primitive data value, i.e. half a REAL data type.
13	Not enough data	The service did not supply enough data to perform the specified operation.
14	Attribute not supported	The attribute specified in the request is not supported.
15	Too much data	The service supplied more data than was expected.
16	Object does not exist	The object specified does not exist in the device.
17	Service fragmentation sequence not in progress	The fragmentation sequence for this service is not currently active for this data.
18	No stored attribute data	The attribute data of this object was not saved prior to the requested service.
19	Store operation failure	The attribute data of this object was not saved due to a failure during the attempt.

General Status Code (in hex)	Status Name	Description of Status
1A	Routing failure, request packet too large	The service request packet was too large for transmission on a network in the path to the destination. The routing device was forced to abort the service.
1B	Routing failure, response packet too large	The service response packet was too large for transmission on a network in the path from the destination. The routing device was forced to abort the service.
1C	Missing attribute list entry data	The service did not supply an attribute in a list of attributes that was needed by the service to perform the requested behavior.
1D	Invalid attribute value list	The service is returning the list of attributes supplied with status information for those attributes that were invalid.
1E	Embedded service error	An embedded service resulted in an error
1F	Vendor specific error	A vendor specific error has been encountered. The Additional Code Field of the Error Response defines the particular error encountered. Use of this General Error Code should only be performed when none of the Error Codes presented in this table or within an Object Class definition accurately reflect the error.
20	Invalid Parameter	A parameter associated with the request was invalid. This code is used when a parameter does not meet the requirements of this specification and/or the requirements defined in an Application Object Specification.
21	Write-once value or medium already written	An attempt was made to write to a write-once medium (e.g. WORM drive, PROM) that has already been written, or to modify a value that cannot be changed once established.
22	Invalid Reply Received	An invalid reply is received (e.g. reply service code does not match the request service code, or reply message is shorter than the minimum expected reply size). This status code can serve for other causes of invalid replies.
23	Buffer Overflow	The message received is larger than the receiving buffer can handle. The entire message was discarded.
24	Message Format Error	The format of the received message is not supported by the server.
25	Key Failure in path	The Key Segment that was included as the first segment in the path does not match the destination module. The object specific status shall indicate which part of the key check failed.
26	Path Size Invalid	The size of the path which was sent with the Service Request is either not large enough to allow the Request to be routed to an object or too much routing data was included.
27	Unexpected attribute in list	An attempt was made to set an attribute that is not able to be set at this time.
28	Invalid Member ID	The Member ID specified in the request does not exist in the specified Class/Instance/Attribute.
29	Member not settable	A request to modify a non-modifiable member was received.
2A	Group 2 only server general failure	This error code may only be reported by DeviceNet Group 2 Only servers with 4K or less code space and only in place of Service not supported, Attribute not supported and Attribute not settable.
2B	Unknown Modbus Error	A CIP to Modbus translator received an unknown Modbus Exception Code.
2C	Attribute not gettable	A request to read a non-readable attribute was received.
2D-CF		Reserved by CIP for future extensions
D0-FF	Reserved for Object Class and Service errors	This range of error codes is to be used to indicate Object Class specific errors. Use of this range should only be performed when none of the Error Codes presented in this table accurately reflect the error that was encountered.



## Appendix I: Troubleshooting

This Appendix addresses potential issues that may occur while using AMP equipment.

**NOTE:** Every drive must be configured with AMP software prior to operation. For stepper systems, use the appropriate Configurator utility, while QuickTuner should be used for servos. It is **never** safe to assume that the configuration state of the drive is known when it is received. This step should not be considered optional.

Error Message / Indication	Explanation	Solution
<p><i>While streaming commands to the drive, it behaves erratically or does not send legible ACK / NACK responses.</i></p>	<p>The drive's command buffer may be full, which may cause unpredictable behavior.</p>	<p>It is recommended that the user receive and process the drive's ACK / NACK character before sending the next command. This will ensure that the drive's command buffer never overflows and the drive behaves normally.</p> <p>If this is not possible, a delay should be introduced between commands that are streamed to the drive. A delay of approximately 10ms should be sufficient for all commands that do not cause motion.</p>
<p><i>"The drive is not responding. Is it connected to the right port and turned on?"</i></p>	<p>The software is unable to communicate to the drive. There are four common causes for this error:</p> <ol style="list-style-type: none"> <li>1 - The drive is not powered.</li> <li>2 - The software is using the wrong COM port.</li> <li>3 - The drive was already running before the software was launched. (wrong power-up sequence)</li> <li>4 - The USB/Serial converter is faulty or not supported by AMP. If an onboard 9-pin COM port is not available, use a USB/Serial converter based on the FTDI chipset. The chipset used will be shown on the converter's documentation. Contact AMP for specific device recommendations.</li> </ol> <p>Hint: If communications have been established, AMP software will display the drive's firmware revision along with the model number. If this box is empty, communications have not been established.</p>	<ol style="list-style-type: none"> <li>1 - Apply power to the drive.</li> <li>2 - Physical 9-pin COM ports are typically assigned COM1 or COM2. USB Adaptors are often assigned arbitrary COM port identifiers. Check your computer's hardware settings in the Control Panel to verify which COM port your device is using.</li> <li>3 - Ensure that the software is running and using the correct COM port. Then, cycle power on the drive. This will allow the software to intercept the drive's power-up packet (as detailed in Appendix B) and initiate communications.</li> </ol>

Error Message / Indication	Explanation	Solution
<p><i>“You have not set the load inertia in the Motor Settings. The electronic damping and anti-resonance will work better if you set the load inertia accurately. Do you want to download your settings anyway?”</i></p>	<p>The drive is missing important information used to properly configure the anti-resonance features. The motor will run without this information, but it may not be as smooth as it otherwise could be. This is generally acceptable only for initial testing, and should be addressed before normal operation.</p>	<p>Set the load inertia. Depending on the configuration software used, it is either possible to enter the actual calculated load inertia or a best-guess estimate of the inertia ratio (load : motor). For example, if the load inertia is five times that of the motor’s rotor, the ratio would be entered as 5 : 1.</p>
<p><i>Drive’s LED blinks red and green</i></p>	<p>An alarm or fault condition exists. The display consists of a specific number of red and green blinks, and will repeat continuously until resolved.</p>	<p>Fault codes are drive-dependent. Consult Appendix E and your drive’s hardware manual for specific information.</p>
<p><i>Drive’s LED shows solid red</i></p>	<p>A firmware download was interrupted, and the drive is unable to boot properly.</p>	<p>Cycle power on the drive and repeat the firmware download process.</p>

## Appendix J: List of Supported Drives

Drive	Description
<b>Integrated Steppers</b>	
STM17S-3AN	NEMA 17 Integrated Stepper, RS-232
STM17S-3AE	NEMA 17 Integrated Stepper, RS-232, Encoder
STM17S-3RN	NEMA 17 Integrated Stepper, RS-485
STM17S-3RE	NEMA 17 Integrated Stepper, RS-485, Encoder
STM17Q-3AN	NEMA 17 Integrated Stepper, Q Programming, RS-232
STM17Q-3AE	NEMA 17 Integrated Stepper, Q Programming, RS-232, Encoder
STM17Q-3RN	NEMA 17 Integrated Stepper, Q Programming, RS-485
STM17Q-3RE	NEMA 17 Integrated Stepper, Q Programming, RS-485, Encoder
STM17C-3CN	NEMA 17 Integrated Stepper, CANOpen
STM17C-3CE	NEMA 17 Integrated Stepper, CANOpen, Encoder
STM23S-2AN	NEMA 23 Integrated Stepper, 2-stack motor, RS-232
STM23S-2AE	NEMA 23 Integrated Stepper, 2-stack motor, RS-232, Encoder
STM23S-2RN	NEMA 23 Integrated Stepper, 2-stack motor, RS-485
STM23S-2RE	NEMA 23 Integrated Stepper, 2-stack motor, RS-485, Encoder
STM23Q-2AN	NEMA 23 Integrated Stepper, 2-stack motor, Q Programming, RS-232
STM23Q-2AE	NEMA 23 Integrated Stepper, 2-stack motor, Q Programming, RS-232, Encoder
STM23Q-2RN	NEMA 23 Integrated Stepper, 2-stack motor, Q Programming, RS-485
STM23Q-2RE	NEMA 23 Integrated Stepper, 2-stack motor, Q Programming, RS-485, Encoder
STM23S-3AN	NEMA 23 Integrated Stepper, 3-stack motor, RS-232
STM23S-3AE	NEMA 23 Integrated Stepper, 3-stack motor, RS-232, Encoder
STM23S-3RN	NEMA 23 Integrated Stepper, 3-stack motor, RS-485
STM23S-3RE	NEMA 23 Integrated Stepper, 3-stack motor, RS-485, Encoder
STM23Q-3AN	NEMA 23 Integrated Stepper, 3-stack motor, Q Programming, RS-232
STM23Q-3AE	NEMA 23 Integrated Stepper, 3-stack motor, Q Programming, RS-232, Encoder
STM23Q-3RN	NEMA 23 Integrated Stepper, 3-stack motor, Q Programming, RS-485
STM23Q-3RE	NEMA 23 Integrated Stepper, 3-stack motor, Q Programming, RS-485, Encoder
STM23C-3CN	NEMA 23 Integrated Stepper, 3-stack motor, Q Programming, CANOpen
STM23C-3CE	NEMA 23 Integrated Stepper, 3-stack motor, Q Programming, CANOpen, Encoder
STM24SF-3AN	NEMA 24 Integrated Stepper, RS-232
STM24SF-3AE	NEMA 24 Integrated Stepper, RS-232, Encoder
STM24SF-3RN	NEMA 24 Integrated Stepper, RS-485
STM24SF-3RE	NEMA 24 Integrated Stepper, RS-485, Encoder
STM24QF-3AN	NEMA 24 Integrated Stepper, Q Programming, RS-232
STM24QF-3AE	NEMA 24 Integrated Stepper, Q Programming, RS-232, Encoder
STM24QF-3RN	NEMA 24 Integrated Stepper, Q Programming, RS-485
STM24QF-3RE	NEMA 24 Integrated Stepper, Q Programming, RS-485, Encoder
STM24C-3CN	NEMA 24 Integrated Stepper, CANOpen
STM24C-3CE	NEMA 24 Integrated Stepper, CANOpen, Encoder

Drive	Description
<b>ST Drives</b>	
ST5-S	5A DC Stepper Drive, RS-232
ST5-Plus	5A DC Stepper Drive, Q Programming, RS-232
ST5-Q-NN	5A DC Stepper Drive, Q Programming, RS-232
ST5-Q-NE	5A DC Stepper Drive, Q Programming, RS-232, Encoder
ST5-Q-RN	5A DC Stepper Drive, Q Programming, RS-485
ST5-Q-RE	5A DC Stepper Drive, Q Programming, RS-485, Encoder
ST5-Q-EN	5A DC Stepper Drive, Q Programming, Ethernet
ST5-Q-EE	5A DC Stepper Drive, Q Programming, Ethernet, Encoder
ST5-IP-EN	5A DC Stepper Drive, Q Programming, EtherNet/IP
ST5-IP-EE	5A DC Stepper Drive, Q Programming, EtherNet/IP, Encoder
ST5-Si-NN	5A DC Stepper Drive, Si Programming, RS-232
ST5-Si-NE	5A DC Stepper Drive, Si Programming, RS-232, Encoder
ST5-C-CN	5A DC Stepper Drive, CANOpen
ST5-C-CE	5A DC Stepper Drive, CANOpen, Encoder
ST10-S	10A DC Stepper Drive, RS-232
ST10-Plus	10A DC Stepper Drive, RS-232
ST10-Q-NN	10A DC Stepper Drive, Q Programming, RS-232
ST10-Q-NE	10A DC Stepper Drive, Q Programming, RS-232, Encoder
ST10-Q-RN	10A DC Stepper Drive, Q Programming, RS-485
ST10-Q-RE	10A DC Stepper Drive, Q Programming, RS-485, Encoder
ST10-Q-EN	10A DC Stepper Drive, Q Programming, Ethernet
ST10-Q-EE	10A DC Stepper Drive, Q Programming, Ethernet, Encoder
ST10-IP-EN	10A DC Stepper Drive, Q Programming, EtherNet/IP
ST10-IP-EE	10A DC Stepper Drive, Q Programming, EtherNet/IP, Encoder
ST10-Si-NN	10A DC Stepper Drive, Si Programming, RS-232
ST10-Si-NE	10A DC Stepper Drive, Si Programming, RS-232, Encoder
ST10-C-CN	10A DC Stepper Drive, CANOpen
ST10-C-CE	10A DC Stepper Drive, CANOpen, Encoder
<b>SV Drives</b>	
SV7-S-AE	7A DC Servo Drive, RS-232, Encoder
SV7-S-AF	7A DC Servo Drive, RS-232, Encoder, MCF Encoder Feedback Board
SV7-S-RE	7A DC Servo Drive, RS-485, Encoder
SV7-Q-AE	7A DC Servo Drive, Q Programming, RS-232, Encoder
SV7-Q-AF	7A DC Servo Drive, Q Programming, RS-232, Encoder, MCF Encoder Feedback Board
SV7-Q-RE	7A DC Servo Drive, Q Programming, RS-485, Encoder
SV7-Q-EE	7A DC Servo Drive, Q Programming, Ethernet, Encoder
SV7-IP-EE	7A DC Servo Drive, Q Programming, EtherNet/IP, Encoder
SV7-Si-AE	7A DC Servo Drive, Si Programming, RS-232, Encoder
SV7-Si-AF	7A DC Servo Drive, Si Programming, RS-232, Encoder, MCF Encoder Feedback Board
SV7-C-CE	7A DC Servo Drive, CANOpen, Encoder

Drive	Description
<b>Blu Servo Drives</b>	
BLuDC4-S	4A DC Servo Drive, RS-232
BLuDC4-SE	4A DC Servo Drive, RS-232, Expanded I/O
BLuDC4-Q	4A DC Servo Drive, RS-232, Q Programming
BLuDC4-QE	4A DC Servo Drive, RS-232, Q Programming, Expanded I/O
BLuDC4-Si	4A DC Servo Drive, RS-232, Si Programming
BLuDC9-S	9A DC Servo Drive, RS-232
BLuDC9-SE	9A DC Servo Drive, RS-232, Expanded I/O
BLuDC9-Q	9A DC Servo Drive, RS-232, Q Programming
BLuDC9-QE	9A DC Servo Drive, RS-232, Q Programming, Expanded I/O
BLuDC9-Si	9A DC Servo Drive, RS-232, Si Programming
BLuAC5-S	5A AC Servo Drive, RS-232
BLuAC5-SE	5A AC Servo Drive, RS-232, Expanded I/O
BLuAC5-Q	5A AC Servo Drive, RS-232, Q Programming
BLuAC5-QE	5A AC Servo Drive, RS-232, Q Programming, Expanded I/O
BLuAC5-Si	5A AC Servo Drive, RS-232, Si Programming
<b>STAC5 Stepper Drives</b>	
STAC5-S-N120	5A 120VAC Stepper Drive, Ethernet
STAC5-S-N220	5A 220VAC Stepper Drive, Ethernet
STAC5-S-E120	5A 120VAC Stepper Drive, Ethernet, Encoder
STAC5-S-E220	5A 220VAC Stepper Drive, Ethernet, Encoder
STAC5-Q-N120	5A 120VAC Stepper Drive, Ethernet, Q Programming
STAC5-Q-N220	5A 220VAC Stepper Drive, Ethernet, Q Programming
STAC5-Q-E120	5A 120VAC Stepper Drive, Ethernet, Q Programming, Encoder
STAC5-Q-E220	5A 220VAC Stepper Drive, Ethernet, Q Programming, Encoder
STAC5-IP-N120	5A 120VAC Stepper Drive, EtherNet/IP
STAC5-IP-N220	5A 220VAC Stepper Drive, EtherNet/IP
STAC5-IP-E120	5A 120VAC Stepper Drive, EtherNet/IP, Encoder
STAC5-IP-E220	5A 220VAC Stepper Drive, EtherNet/IP, Encoder
<b>STAC6 Stepper Drives</b>	
STAC6-S	6A 120VAC Stepper Drive, RS-232
STAC6-S-220	6A 220VAC Stepper Drive, RS-232
STAC6-SE	6A 120VAC Stepper Drive, RS-232, Expanded I/O
STAC6-SE-220	6A 220VAC Stepper Drive, RS-232, Expanded I/O
STAC6-Q	6A 120VAC Stepper Drive, RS-232, Q Programming
STAC6-Q-220	6A 220VAC Stepper Drive, RS-232, Q Programming
STAC6-QE	6A 120VAC Stepper Drive, RS-232, Q Programming, Expanded I/O
STAC6-QE-220	6A 220VAC Stepper Drive, RS-232, Q Programming, Expanded I/O

Drive	Description
STAC6-Si	6A 120VAC Stepper Drive, RS-232, Si Programming
STAC6-Si-220	6A 220VAC Stepper Drive, RS-232, Si Programming
STAC6-C	6A 120VAC Stepper Drive, CANOpen
STAC6-C-220	6A 220VAC Stepper Drive, CANOpen
<b>SVAC3 Servo Drives</b>	
SVAC3-S-E-120	3A 120VAC Servo Drive, Ethernet
SVAC3-S-E-220	3A 220VAC Servo Drive, Ethernet
SVAC3-Q-E-120	3A 120VAC Servo Drive, Ethernet, Q Programming
SVAC3-Q-E-220	3A 220VAC Servo Drive, Ethernet, Q Programming
SVAC3-IP-E-120	3A 120VAC Servo Drive, Ethernet, Q Programming, EtherNet/IP
SVAC3-IP-E-220	3A 220VAC Servo Drive, Ethernet, Q Programming, EtherNet/IP

Drive	Description
<b>StepSERVO integrated motors</b>	
TSM11Q-1RM	NEMA 11 Integrated StepSERVO™ Motor w/ Q Programming & Modbus/RTU
TSM11Q-2RM	NEMA 11 Integrated StepSERVO™ Motor w/ Q Programming & Modbus/RTU
TSM11Q-3RM	NEMA 11 Integrated StepSERVO™ Motor w/ Q Programming & Modbus/RTU
TSM17C-1CG	NEMA 17 Integrated CANopen StepSERVO™ Motor w/ Q Programming
TSM17C-2CG	NEMA 17 Integrated CANopen StepSERVO™ Motor w/ Q Programming
TSM17C-3CG	NEMA 17 Integrated CANopen StepSERVO™ Motor w/ Q Programming
TSM17P-1AG	NEMA 17 Integrated StepSERVO™ Motor w/ Pulse & Direction Control
TSM17P-2AG	NEMA 17 Integrated StepSERVO™ Motor w/ Pulse & Direction Control
TSM17P-3AG	NEMA 17 Integrated StepSERVO™ Motor w/ Pulse & Direction Control
TSM17Q-1AG	NEMA 17 Integrated StepSERVO™ Motor w/ Q Programming & Modbus/RTU
TSM17Q-1RG	NEMA 17 Integrated StepSERVO™ Motor w/ Q Programming & Modbus/RTU
TSM17Q-2AG	NEMA 17 Integrated StepSERVO™ Motor w/ Q Programming & Modbus/RTU
TSM17Q-2RG	NEMA 17 Integrated StepSERVO™ Motor w/ Q Programming & Modbus/RTU
TSM17Q-3AG	NEMA 17 Integrated StepSERVO™ Motor w/ Q Programming & Modbus/RTU
TSM17Q-3RG	NEMA 17 Integrated StepSERVO™ Motor w/ Q Programming & Modbus/RTU
TSM23C-2CG	NEMA 23 Integrated CANopen StepSERVO™ Motor w/ Q Programming
TSM23C-3CG	NEMA 23 Integrated CANopen StepSERVO™ Motor w/ Q Programming
TSM23C-4CG	NEMA 23 Integrated CANopen StepSERVO™ Motor w/ Q Programming
TSM23P-2AG	NEMA 23 Integrated StepSERVO™ Motor w/ Pulse & Direction Control
TSM23P-3AG	NEMA 23 Integrated StepSERVO™ Motor w/ Pulse & Direction Control
TSM23P-4AG	NEMA 23 Integrated StepSERVO™ Motor w/ Pulse & Direction Control
TSM23Q-2AG	NEMA 23 Integrated StepSERVO™ Motor w/ Q Programming & Modbus/RTU
TSM23Q-2RG	NEMA 23 Integrated StepSERVO™ Motor w/ Q Programming & Modbus/RTU
TSM23Q-3AG	NEMA 23 Integrated StepSERVO™ Motor w/ Q Programming & Modbus/RTU
TSM23Q-3RG	NEMA 23 Integrated StepSERVO™ Motor w/ Q Programming & Modbus/RTU
TSM23Q-4AG	NEMA 23 Integrated StepSERVO™ Motor w/ Q Programming & Modbus/RTU
TSM23Q-4RG	NEMA 23 Integrated StepSERVO™ Motor w/ Q Programming & Modbus/RTU
TSM23S-2AG	NEMA 23 Integrated StepSERVO™ Motor w/ Streaming Command support
TSM23S-2RG	NEMA 23 Integrated StepSERVO™ Motor w/ Streaming Command support
TSM23S-3AG	NEMA 23 Integrated StepSERVO™ Motor w/ Streaming Command support
TSM23S-3RG	NEMA 23 Integrated StepSERVO™ Motor w/ Streaming Command support
TSM23S-4AG	NEMA 23 Integrated StepSERVO™ Motor w/ Streaming Command support
TSM23S-4RG	NEMA 23 Integrated StepSERVO™ Motor w/ Streaming Command support

Drive	Description
<b>StepSERVO integrated motors</b>	
TXM24C-1CG	IP65 Rated NEMA 24 Integrated CANopen StepSERVO™ Motor
TXM24C-3CG	IP65 Rated NEMA 24 Integrated CANopen StepSERVO™ Motor
TXM24IP-1EG	IP65 Rated NEMA 24 Integrated StepSERVO™ Motor w/ EtherNet/IP
TXM24IP-3EG	IP65 Rated NEMA 24 Integrated StepSERVO™ Motor w/ EtherNet/IP
TXM24Q-1AG	IP65 Rated NEMA 24 Integrated StepSERVO™ Motor w/ Q Programming & Modbus/RTU
TXM24Q-3AG	IP65 Rated NEMA 24 Integrated StepSERVO™ Motor w/ Q Programming & Modbus/RTU
TXM24Q-1EG	IP65 Rated NEMA 24 Integrated StepSERVO™ Motor w/ Q Programming
TXM24Q-3EG	IP65 Rated NEMA 24 Integrated StepSERVO™ Motor w/ Q Programming
TXM24Q-1RG	IP65 Rated NEMA 24 Integrated StepSERVO™ Motor w/ Q Programming & Modbus/RTU
TXM24Q-3RG	IP65 Rated NEMA 24 Integrated StepSERVO™ Motor w/ Q Programming & Modbus/RTU
TXM24S-1AG	IP65 Rated NEMA 24 Integrated StepSERVO™ Motor
TXM24S-3AG	IP65 Rated NEMA 24 Integrated StepSERVO™ Motor
TXM24S-1EG	IP65 Rated NEMA 24 Integrated StepSERVO™ Motor
TXM24S-3EG	IP65 Rated NEMA 24 Integrated StepSERVO™ Motor
TXM24S-1RG	IP65 Rated NEMA 24 Integrated StepSERVO™ Motor
TXM24S-3RG	IP65 Rated NEMA 24 Integrated StepSERVO™ Motor

Drive	Description
<b>StepSERVO integrated motors</b>	
SSM23IP-2EG	NEMA 23 Integrated StepSERVO™ Motor w/ EtherNet/IP
SSM23IP-3EG	NEMA 23 Integrated StepSERVO™ Motor w/ EtherNet/IP
SSM23IP-4EG	NEMA 23 Integrated StepSERVO™ Motor w/ EtherNet/IP



Drive	Description
<b>SV200 Servo Drives</b>	
SV2A3-C-CE	78-139 VAC Digital Servo Drive w/ CANopen interface
SV2A3-P-NE	78-139 VAC Digital Servo Drive
SV2A3-Q-AE	78-139 VAC Digital Servo Drive w/ On-board motion control
SV2A3-Q-EE	78-139 VAC Digital Servo Drive w/ On-board motion control
SV2A3-Q-RE	78-139 VAC Digital Servo Drive w/ On-board motion control
SV2A5-C-CE	78-139 VAC Digital Servo Drive w/ CANopen interface
SV2A5-P-NE	78-139 VAC Digital Servo Drive
SV2A5-Q-AE	78-139 VAC Digital Servo Drive w/ On-board motion control
SV2A5-Q-EE	78-139 VAC Digital Servo Drive w/ On-board motion control
SV2A5-Q-RE	78-139 VAC Digital Servo Drive w/ On-board motion control
SV2B3-C-CE	156-264 VAC Digital Servo Drive w/ CANopen interface
SV2B3-P-NE	156-264 VAC Digital Servo Drive
SV2B3-Q-AE	156-264 VAC Digital Servo Drive w/ On-board motion control
SV2B3-Q-EE	156-264 VAC Digital Servo Drive w/ On-board motion control
SV2B3-Q-RE	156-264 VAC Digital Servo Drive w/ On-board motion control
SV2B5-C-CE	156-264 VAC Digital Servo Drive w/ CANopen interface
SV2B5-P-NE	156-264 VAC Digital Servo Drive
SV2B5-Q-AE	156-264 VAC Digital Servo Drive w/ On-board motion control
SV2B5-Q-EE	156-264 VAC Digital Servo Drive w/ On-board motion control
SV2B5-Q-RE	156-264 VAC Digital Servo Drive w/ On-board motion control

## Appendix K: Modbus appendix

*Covers the following Modbus® RTU enabled drives:*

<i>ST5-Q-NE</i>	<i>STM23Q-2AE</i>	<i>TSM11Q-1RM</i>
<i>ST5-Q-NF</i>	<i>STM23Q-2AN</i>	<i>TSM11Q-2RM</i>
<i>ST5-Q-NN</i>	<i>STM23Q-2RE</i>	<i>TSM11Q-3RM</i>
<i>ST5-Q-RE</i>	<i>STM23Q-2RN</i>	
<i>ST5-Q-RN</i>	<i>STM23Q-3AE</i>	<i>TSM17Q-1AG</i>
	<i>STM23Q-3AN</i>	<i>TSM17Q-1RG</i>
<i>ST10-Q-NE</i>	<i>STM23Q-3RE</i>	<i>TSM17Q-2AG</i>
<i>ST10-Q-NF</i>	<i>STM23Q-3RN</i>	<i>TSM17Q-2RG</i>
<i>ST10-Q-NN</i>		<i>TSM17Q-3AG</i>
<i>ST10-Q-RE</i>	<i>STM24QF-3AE</i>	<i>TSM17Q-3RG</i>
<i>ST10-Q-RN</i>	<i>STM24QF-3AN</i>	<i>TSM23Q-2AG</i>
	<i>STM24QF-3RE</i>	<i>TSM23Q-2RG</i>
<i>STM17Q-3AE</i>	<i>STM24QF-3RN</i>	<i>TSM23Q-3AG</i>
<i>STM17Q-3AN</i>		<i>TSM23Q-3RG</i>
<i>STM17Q-3RE</i>	<i>SV2A3-Q-RE</i>	
<i>STM17Q-3RN</i>	<i>SV2B3-Q-RE</i>	<i>TXM24Q-1AG</i>
	<i>SV2A5-Q-RE</i>	<i>TXM24Q-1RG</i>
	<i>SV2B5-Q-RE</i>	<i>TXM24Q-3AG</i>
		<i>TXM24Q-3RG</i>
	<i>SWM24QF-3AE</i>	
	<i>SWM24QF-3AN</i>	

*Also covers the following Modbus<sup>®</sup> TCP enabled drives:*

<i>ST5-Q-EE</i>	<i>STM24Q-3EE</i>	<i>TXM24Q-1EG</i>
<i>ST5-Q-EN</i>	<i>STM24Q-3EN</i>	<i>TXM24Q-3EG</i>
<i>ST10-Q-EE</i>		
<i>ST10-Q-EN</i>	<i>SWM24Q-3EE</i>	<i>SV2A3-Q-EE</i>
		<i>SV2A5-Q-EE</i>
<i>STM23Q-2EE</i>	<i>SSM23IP-2EG</i>	
<i>STM23Q-2EN</i>	<i>SSM23IP-3EG</i>	<i>SV2B3-Q-EE</i>
<i>STM23Q-3EE</i>	<i>SSM23IP-4EG</i>	<i>SV2B5-Q-EE</i>
<i>STM23Q-3EN</i>		

## What is Modbus?

Modbus, originally created by Modicon, is a fieldbus that allows a master and one or more slave devices to share data. These data are organized into 16-bit registers, which can also be used to share information single-bit I/O points.

It is a popular protocol with PLC vendors due to its simplicity and the inherent ease of sending PLC register data (often 16-bits in width) over a fieldbus protocol optimized for 16-bit data.

The master may initiate read and write operations on single registers or blocks of registers. While there is no rule to this effect, it is common for the master to read and write on a periodic time base (polling), rather than sending and requesting data only when it is needed. In this manner, PLC register data is ensured to be valid and consistent as a representation of the slave device's status.

Getting help: we offer Modbus application notes and sample code for popular PLCs and HMIs in the support section of our website. Please visit [www.applied-motion.com/support/application-notes](http://www.applied-motion.com/support/application-notes)

## Wiring

### Modbus/RTU:

Modbus RTU uses the standard RS-232 or RS-485 physical layer.

RS-232 is a point-to-point communications scheme, and as such the largest possible network would consist of a single slave drive. Please note that even though it will be the only device on the "network", it will still require an address. This address may be an integer value from 1-32, and is set through the *ST Configurator™* software during initial configuration.

For drives with RS-485 communications, there are a few things to consider.

It is possible to use 2-wire RS-485 for operational communication over Modbus, however 4-wire RS-485 is required for use with all Applied Motion configuration and programming software (i.e., *ST Configurator™* and *Q Programmer™*). As such, we recommend that all RS-485 networks be constructed using the 4-wire method.

Be sure to consult your drive's hardware manual for specific wiring details.

### Modbus/TCP

Modbus TCP uses the Ethernet physical layer. Connect your drive(s) to the host using standard Ethernet cabling and if necessary an Ethernet switch or router. Port 502 is used for communication per the Modbus standard.

## Drive configuration

First, download and install the most recent version of the appropriate software from the Applied Motion Products website ([www.applied-motion.com](http://www.applied-motion.com)). For the ST, STAC, and STM series, use *ST Configurator™* software. For the TSM series, use *Step-Servo Quick Tuner™*. For SV2 models, use *SVX Servo Suite™*. For RS-485 drives you will also need a USB-to-RS-485 converter, such as the USB-COMi-M module available from AMP. Consult your drive's manual for wiring and general communication instructions.

1. Launch software and select the appropriate COM port. For Ethernet drives, enter the IP address of the drive you wish to configure.
2. Apply power to the drive. Note, perform this step with only a single drive on the network. Each drive must be configured individually before it may be used on a network.
3. The Software will automatically identify the drive, but will not upload all parameters. Click "Upload from Drive". This will ensure that the software accurately reflects the current state of the drive's configuration parameters.
4. Click "Motion & I/O" in *ST Configurator™*. In *Step-Servo Quick Tuner™* and *SVX Servo Suite™* use the *Configuration panel*.

5. for Modbus RTU drives, specify the drive's node address and baud rate.
6. For drives with Flex/IO, confirm the desired I/O settings. Click OK to return to the main screen.
7. Set any desired motor and encoder configurations your application may require.
8. Click Download to Drive to save the settings.
9. Optionally, use *Q Programmer™* to write and download a program for this axis. The drive may be configured to launch the program automatically upon powerup, or to wait for the QX command to be sent from the Modbus master.
10. Remove power from the drive and install into the main machine network.
11. Repeat for all other slave nodes, taking care to ensure each has a unique node address.

**Note, the drive must be rebooted to switch between Modbus and configuration modes.**

## Drive Behavior

An extensive list of registers has been made available, allowing the user to monitor or change every detail of the drive's status. It is also possible to send commands to a specific register, mimicking the behavior of our proprietary SCL command set. The capability allows a PLC to have unparalleled control over the drive's behavior at runtime.

The drive will respond to the following Modbus function codes:

- |    |                          |
|----|--------------------------|
| 3  | Read Holding Registers   |
| 4  | Read Input Registers     |
| 6  | Write Single Register    |
| 16 | Write Multiple Registers |

## Monitoring

See the Register Map table for details on specific data that can be monitored and written in this manner.

## Sending Commands

The Command Opcode register, 40125, is designated to receive encoded SCL commands via Modbus. Many SCL commands have been made available in this manner, and will allow the user full control over the motion capabilities of the drive.

SCL command encoding details can be found in the Modbus Register Table.

## Examples

### Point-to-Point Moves

Four pieces of data are required to fully define a point-to-point move. Acceleration, Deceleration, Distance, and Velocity. Followed of course by the move command itself. To command such a move over Modbus, we must first write to the aforementioned control registers, then send the command.

Function	Register	Value	Notes
Acceleration	40028	100	Units: 10 RPM/sec
Deceleration	40029	100	Units: 10 RPM/sec
Velocity	40030	240	Units: 0.25 RPM
Distance	40031..32	20000	This register is affected by Endianness setting

Now it's time for the command itself. The most common point-to-point move is the Feed to Length which uses the SCL command FL. In Modbus we do the following:

The drive will execute the move command immediately, pulling the relevant parameter data from the above registers. It is immediately ready to accept another command. Note, it is not necessary to send parameter data with each command, unless this data changes between moves. For example, to repeat a move simply send the command again, leaving the relevant parameter data unchanged.

Function	Register	Value	Notes
FL Command	40125	102	0x66 (Hexadecimal) is equal to 102

### Launch a Q Program

It is possible to execute a stored Q program over Modbus using the QX command (opcode 0x78). This command requires a value to be written to Parameter 1, the first of 5 registers set aside for command-dependant parameter data.

To launch the program at segment 1, we would use the SCL command QX1. Over Modbus, the following procedure applies.

First, configure the parameter data (only Parameter 1 is used by this command).

Now we can send the QX command itself.

Function	Register	Value	Notes
Parameter 1	40126	1	Q segment to execute. Integer: 1..12

Function	Register	Value	Notes
QX Command	40125	120	0x78 (Hexadecimal) is equal to 120 decimal

Note, to stop a command or interrupt a Q program, either the SK or SKD commands may be used.

Function	Register	Value	Notes
SK Command	40125	225	0xE1 (Hexadecimal) is equal to 225

Function	Register	Value	Notes
SKD Command	40125	226	0xE2 (Hexadecimal) is equal to 226

Modbus Register Table				
Register	Access	Data Type	Description	SCL Register
40001	Read Only	SHORT	Alarm Code (AL)	f
40002	Read Only	SHORT	Status Code (SC)	s
40003	Read Only	SHORT	Immediate Expanded Inputs (IS) Output Status (Only for SV200)	y
40004	Read Only	SHORT	Input Status	i
40005..6	Read Only	LONG	Encoder Position (IE, EP)	e
40007..8	Read Only	LONG	Immediate Absolute Position	l
40009..10	Write	LONG	Absolute Position Command	P
40011	Read Only	SHORT	Immediate Actual Velocity (IV0)	v
40012	Read Only	SHORT	Immediate Target Velocity (IV1)	w
40013	Read Only	SHORT	Immediate Drive Temperature (IT)	t
40014	Read Only	SHORT	Immediate Bus Voltage (IU)	u
40015..16	Read Only	LONG	Immediate Position Error (IX)	x
40017	Read Only	SHORT	Immediate Analog Input Value (IA)	a
40018	Read Only	SHORT	Q Program Line Number	b
40019	Read Only	SHORT	Immediate Current Command (IC)	c
40020..21	Read Only	LONG	Relative Distance (ID)	d
40022..23	Read Only	LONG	Sensor Position	g
40024	Read Only	SHORT	Condition Code	h
40025	Read Only	SHORT	Analog Input 1 (IA1)	j
40026	Read Only	SHORT	Analog Input 2 (IA2)	k
40027	Read Only	SHORT	Command Mode (CM)	m
40028	R/W	SHORT	Point-to-Point Acceleration (AC)	A
40029	R/W	SHORT	Point-to-Point Deceleration (DE)	B
40030	R/W	SHORT	Velocity (VE)	V
40031..32	R/W	LONG	Point-to-Point Distance (DI)	D
40033..34	R/W	LONG	Change Distance (DC)	C
40035	R/W	SHORT	Change Velocity (VC)	U
40036	Read Only	SHORT	Velocity Move State	n
40037	Read Only	SHORT	Point-to-Point Move State	o
40038	Read Only	SHORT	Q Program Segment Number	p
40039	Read Only	SHORT	Average Clamp Power (regen) *	r
40040	Read Only	SHORT	Phase Error	z
40041..42	R/W	LONG	Position Offset	E
40043	R/W	SHORT	Miscellaneous Flags	F
40044	R/W	SHORT	Current Command (GC)	G

\*Not applicable to SV200 series, register values greater than 40130 are SV200 drives only.

<sup>1</sup> For SV200 drives: Max. Velocity Limit

<sup>2</sup> For SV200 series, Firmware Version (ASCII value)

40045..46	R/W	LONG	Input Counter	I
40047	R/W	SHORT	Jog Accel (JA)	
40048	R/W	SHORT	Jog Decel (JL)	
40049	R/W	SHORT	Jog Velocity (JS)	J
40050	R/W	SHORT	Accel/Decel Current (CA) <sup>1</sup>	
40051	R/W	SHORT	Running Current (CC) for stepper, Continuous Current for servo	N
40052	R/W	SHORT	Idle Current (CI) for stepper Peak Current (CP) for servo	O
40053	R/W	SHORT	Steps per Revolution *	R
40054~40055	R/W	LONG	Pulse Counter	S
40056	R/W	SHORT	Analog Position Gain (AP)	X
40057	R/W	SHORT	Analog Threshold (AT)	Y
40058	R/W	SHORT	Analog Offset (AV)	Z
40059..60	R/W	LONG	Accumulator	0
40061..62	R/W	LONG	User Defined Register	1
40063..64	R/W	LONG	User Defined Register	2
40065..66	R/W	LONG	User Defined Register	3
40067..68	R/W	LONG	User Defined Register	4
40069..70	R/W	LONG	User Defined Register	5
40071..72	R/W	LONG	User Defined Register	6
40073..74	R/W	LONG	User Defined Register	7
40075..76	R/W	LONG	User Defined Register	8
40077..78	R/W	LONG	User Defined Register	9
40079..80	R/W	LONG	User Defined Register	:
40081..82	R/W	LONG	User Defined Register	;
40083..84	R/W	LONG	User Defined Register	<
40085..86	R/W	LONG	User Defined Register	=
40087..88	R/W	LONG	User Defined Register	>
40089..90	R/W	LONG	User Defined Register	?
40091..92	R/W	LONG	User Defined Register	@
40093..94	R/W	LONG	User Defined Register	[
40095..96	R/W	LONG	User Defined Register	\
40097..98	R/W	LONG	User Defined Register	]
40099..100	R/W	LONG	User Defined Register	^
40101..102	R/W	LONG	User Defined Register	_
400103..104	R/W	LONG	User Defined Register	`
40105	R/W	SHORT	Brake Release Delay	

\*Not applicable to SV200 series, register values greater than 40130 are SV200 drives only.

<sup>1</sup> For SV200 drives: Max. Velocity Limit

<sup>2</sup> For SV200 series, Firmware Version (ASCII value)



40106	R/W	SHORT	Brake Engage Delay	
40107	R/W	SHORT	Idle Current Delay *	
40108	R/W	SHORT	Hyperbolic Smoothing Gain *	
40109	Read Only	SHORT	Hyperbolic Smoothing Phase <sup>2</sup>	
40110	R/W	SHORT	Analog Filter Gain	
40111	Read Only	SHORT	(reserved)	
40112	Read Only	SHORT	Alarm Code High bits	
40113	R/W	SHORT	Jog Change Speed1 (JC1)	
40114	R/W	SHORT	Jog Change Speed2 (JC2)	
40115	R/W	SHORT	Jog Change Speed3 (JC3)	
40116	R/W	SHORT	Jog Change Speed4 (JC4)	
40117	R/W	SHORT	Jog Change Speed5 (JC5)	
40118	R/W	SHORT	Jog Change Speed6 (JC6)	
40119	R/W	SHORT	Jog Change Speed7 (JC7)	
40120	R/W	SHORT	Jog Change Speed8 (JC8)	
40121	R/W	SHORT	X9 Input Filter	
40122	R/W	SHORT	X10 Input Filter	
40123	R/W	SHORT	X11 Input Filter	
40124	R/W	SHORT	X12 Input Filter	
40125	R/W	SHORT	Command Opcode	
40126	R/W	SHORT	Parameter 1	
40127	R/W	SHORT	Parameter 2	
40128	R/W	SHORT	Parameter 3	
40129	R/W	SHORT	Parameter 4	
40130	R/W	SHORT	Parameter 5	
40131	R/W	SHORT	Global Gain	
40132	R/W	SHORT	Global Gain1	
40133	R/W	SHORT	Proportional Gain (KF) Position Loop	
40134	R/W	SHORT	Differential Gain (KD) "Damping" Gain	
40135	R/W	SHORT	Velocity Feedback Gain (KV)	
40136	R/W	SHORT	Integral Gain (KI)	
40137	R/W	SHORT	Inertia Feedforward Gain (KK)	
40138	R/W	SHORT	Jerk Filter (KJ) "Smoothing" Filter	
40139	R/W	SHORT	Velocity Loop Proportional Gain (VP)	
40140	R/W	SHORT	Velocity Loop Integral Gain (VI)	
40141	R/W	SHORT	Damping Filter Gain (KE)	
40142	R/W	SHORT	Current Filter Gain (KC)	
40143	R/W	SHORT	Control Mode (CM)	

\*Not applicable to SV200 series, register values greater than 40130 are SV200 drives only.

<sup>1</sup> For SV200 drives: Max. Velocity Limit

<sup>2</sup> For SV200 series, Firmware Version (ASCII value)

40144	R/W	SHORT	Control Mode 1	
40145	R/W	SHORT	Operating Mode "Power-up Mode"	
40146	R/W	SHORT	Jog Mode (JM)	
40147	R/W	SHORT	Hard-Stop Current Limit (HC)	
40148	R/W	SHORT	Max Acceleration (AM)	
40149	Read Only	SHORT	Encoder Resolution (quad counts divided by motor poles)	
40150	Read Only	SHORT	(Reserved)	
40151	Read Only	SHORT	½ Electronic Gearing value (Step Resolution)	
40152	R/W	SHORT	Electronic Ratio Numerator	
40153	R/W	SHORT	Electronic Ratio Denominator	
40154	R/W	SHORT	Step Input Pulse Type (lower bits) Step Input Noise Filter (upper bits)	
40155	R/W	SHORT	Position Fault limit (PF)	
40156	R/W	SHORT	In-Position Count	
40157	R/W	SHORT	Position Error Range	
40158	R/W	SHORT	In-Range Count	
40159	R/W	SHORT	Pulse Input Complete Time	
40160	R/W	SHORT	Analog Velocity Gain	
40161	R/W	SHORT	Analog Torque Gain	
40162	R/W	SHORT	Analog Offset 1	
40163	R/W	SHORT	Analog Offset 2	
40164	R/W	SHORT	Analog Type	
40165	R/W	SHORT	Analog Deadband 1	
40166	R/W	SHORT	Analog Deadband 2	
40167	R/W	SHORT	Differential Analog Deadband	
40168	R/W	SHORT	Analog Function	
40169	R/W	SHORT	Servo Enable Input Usage (SI)	
40170	R/W	SHORT	Alarm Reset Input (AI)	
40171	R/W	SHORT	Define Limits Input (DL)	
40172	R/W	SHORT	Motion Input X7 X8 X9 X10 inputs	
40173	R/W	SHORT	Alarm Output(AO)	
40174	R/W	SHORT	Brake Output (BO)	
40175	R/W	SHORT	Motion Output Y3 Y4 Y5 Y6 inputs	
40176		SHORT	(Reserved)	
40177	R/W	SHORT	Communication Protocol (PR)	
40178	R/W	SHORT	Transmit Delay (TD)	
40179	R/W	SHORT	Baud Rate (BR)	

\*Not applicable to SV200 series, register values greater than 40130 are SV200 drives only.

<sup>1</sup> For SV200 drives: Max. Velocity Limit

<sup>2</sup> For SV200 series, Firmware Version (ASCII value)

40180	R/W	SHORT	Communication Address (DA represented as ASCII value)	
40181	R/W	SHORT	Velocity Reached Value	
40182	R/W	SHORT	Tach-out Count setting	
40183	R/W	SHORT	Torque Reached Value (Units: 0.01A)	
40184	R/W	SHORT	Front Panel Parameters Lock	
40185	R/W	SHORT	Front Panel Default Display setting	
40186	R/W	SHORT	Mask Alarm setting	
40187	R/W	SHORT	Homing Acceleration 1	
40188	R/W	SHORT	Homing Acceleration 2	
40189	R/W	SHORT	Homing Acceleration 3	
40190	R/W	SHORT	Homing Deceleration 1	
40191	R/W	SHORT	Homing Deceleration 2	
40192	R/W	SHORT	Homing Deceleration 3	
40193	R/W	SHORT	Homing Velocity 1	
40194	R/W	SHORT	Homing Velocity 2	
40195	R/W	SHORT	Homing Velocity 3	
40196	R/W	SHORT	Clamp Resistance	
40197	R/W	SHORT	Clamp Count	
40198	R/W	SHORT	Clamp time	
40199	Read Only	SHORT	Drive Model ID Number	
40200	Read Only	SHORT	Drive Sub Model ID Number	

\*Not applicable to SV200 series, register values greater than 40130 are SV200 drives only.

<sup>1</sup> For SV200 drives: Max. Velocity Limit

<sup>2</sup> For SV200 series, Firmware Version (ASCII value)

SCL Command Encoding Table							
Function	SCL	Opcode	Parameter 1	Parameter 2	Parameter 3	Parameter 4	Parameter 5
Alarm Reset	AX	0xBA	N/A	N/A	N/A	N/A	N/A
Start Jogging	CJ	0x96	N/A	N/A	N/A	N/A	N/A
Stop Jogging	SJ	0xD8	N/A	N/A	N/A	N/A	N/A
Encoder Function	EF	0xD6	0,1,2 or 6	N/A	N/A	N/A	N/A
Encoder Position	EP	0x98	Position	N/A	N/A	N/A	N/A
Feed to Double Sensor	FD	0x69	I/O Point 1	Condition 1	I/O Point 2	Condition 2	N/A
Follow Encoder	FE	0xCC	I/O Point	Condition	N/A	N/A	N/A
Feed to Length	FL	0x66	N/A	N/A	N/A	N/A	N/A
Feed to Sensor with Mask Distance	FM	0x6A	I/O Point	Condition	N/A	N/A	N/A
Feed and Set Output	FO	0x68	I/O Point	Condition	N/A	N/A	N/A
Feed to Position	FP	0x67	N/A	N/A	N/A	N/A	N/A
Feed to Sensor	FS	0x6B	I/O Point	Condition	N/A	N/A	N/A
Feed to Sensor with Safety Distance	FY	0x6C	I/O Point	Condition	N/A	N/A	N/A
Jog Disable	JD	0xA3	N/A	N/A	N/A	N/A	N/A
Jog Enable	JE	0xA2	N/A	N/A	N/A	N/A	N/A
Motor Disable	MD	0x9E	N/A	N/A	N/A	N/A	N/A
Motor Enable	ME	0x9F	N/A	N/A	N/A	N/A	N/A
Seek Home	SH	0x6E	I/O Point	Condition	N/A	N/A	N/A
Set Position	SP	0xA5	Position	N/A	N/A	N/A	N/A
Filter Input	FI	0xC0	I/O Point	Filter Time	N/A	N/A	N/A
Filter Select Inputs	FX	0xD3	N/A	N/A	N/A	N/A	N/A
Step Filter Freq	SF	0x06	Freq	N/A	N/A	N/A	N/A
Analog Deadband	AD	0xD2	0.001 V	N/A	N/A	N/A	N/A
Alarm Reset Input	AI	0x46	Function ('1'..'3')	I/O Point	N/A	N/A	N/A
Alarm Output	AO	0x47	Function ('1'..'3')	I/O Point	N/A	N/A	N/A
Analog Scaling	AS	0xD1	N/A	N/A	N/A	N/A	N/A
Define Limits	DL	0x42	1..3	N/A	N/A	N/A	N/A
Set Output	SO	0x8B	I/O Point	Condition	N/A	N/A	N/A
Wait for Input	WI	0x70	N/A	N/A	N/A	N/A	N/A
Queue Load & Execute	QX	0x78	1..12	N/A	N/A	N/A	N/A
Wait Time	WT	0x6F	0.01 sec	N/A	N/A	N/A	N/A
Stop Move, Kill Buffer	SK	0xE1	N/A	N/A	N/A	N/A	N/A
Stop Move, Kill Buffer, Normal Decel	SKD	0xE2	N/A	N/A	N/A	N/A	N/A

N/A = Not Applicable

Notes:

- 32-bit values may be either big-endian or little-endian. Endianness is determined by Bit 6 of the PR command word. It is recommended that this setting be configured with the configuration software.
- Consult the I/O Encoding Table for details on parameter data for commands referencing I/O.

## IO Encoding Table

Useful ASCII values for IO commands. Character values shown are taken from standard SCL command nomenclature. For example, a Feed to Sensor command example may utilize the falling edge of input 1 and appear as FS1F. To encode this command the user would select 0x31 for the character '1' and 0x46 for the character 'F'. These codes must be written to the appropriate parameter register before writing the desired command opcode to register 40125.

Character	hex code	
'0'	0x30	encoder index
'1'	0x31	input 1 or output 1
'2'	0x32	input 2 or output 2
'3'	0x33	input 3 or output 3
'4'	0x34	input 4 or output 4
'5'	0x35	input 5 or output 5
'6'	0x36	input 6 or output 6
'7'	0x37	input 7
'8'	0x38	input 8
'9'	0x39	input 9
':'	0x3A	input 10
','	0x3B	input 11
'<'	0x3C	input 12
'L'	0x4C	low state (closed)
'H'	0x48	high state (open)
'R'	0x52	rising edge
'F'	0x46	falling edge

To execute a feed to sensor routine active on a low (closed) condition for input 3:

FUNCTION	REGISTER	VALUE	NOTES
define input #	40126	51	0x33 (Hexadecimal) equals 51 decimal
define input condition	40127	76	0x4C equals 76 decimal
Feed to Sensor	40125	107	0x6B equals 107 decimal

Note: For direction control, the sign of the value loaded into register 40031..32 (DI) is used. Prior to writing the Feed to Sensor opcode to register 40125, be sure to write the input number and condition to Parameter 1 (40126) and Parameter 2 (40127) respectively.

(This page intentionally left blank)



Applied Motion Products  
404 Westridge Drive  
Watsonville, CA 95076  
USA  
tel / 831-761-6555

[www.applied-motion.com](http://www.applied-motion.com)