

# Scintillator-based Hadron Calorimetry for the ILC

Dhiman Chakraborty

For the NICADD/NIU ILC detector group

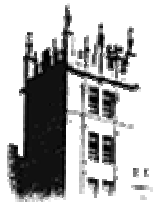

NORTHERN ILLINOIS  
UNIVERSITY



Linear Collider Study Group Meeting  
26 May, 2005

# Outline

- Motivation
  - Particle–Flow Algorithms
  - Why (not) scintillators?
- Design Considerations: PFA + Others
- Hardware tests
  - Cells of various types, shapes, surface treatments,...
  - Extruded scintillators: miscellaneous response characteristics
  - Photodetectors
- Simulation studies (by V. Zutshi)
  - Performance vs. size, analog vs. 1– and 2–bit digital approach
  - Density–weighted clustering
  - comparison with gas–based technologies
- Beam test preparations
  - A lot of work in progress, details in a later talk
- Summary

# Motivation: PFAs

In a world without neutral particles, who needs a calorimeter?

Imagine a jet at the ILC that is typical in all respects, except that it contains no neutrals. It's momentum can be measured within 0.1% using a good tracker alone.

- Try to use calorimetry to measure neutrals only.
- Unfortunately, can't prevent all the charged particles from reaching the calorimeter – the best we can do is to try to steer them away as much as possible with a strong magnetic field.

# Particle-Flow Algorithms

A typical jet consists of

- 64% charged particles:
- 25% photons:
- 10% neutral hadrons:

$$\sigma(p) \approx 0$$

$$\sigma(E) \approx 0.15\sqrt{E / \text{GeV}}$$

$$\sigma(E) \approx 0.5\sqrt{E / \text{GeV}}$$

The charged particles are more precisely measured in the tracker

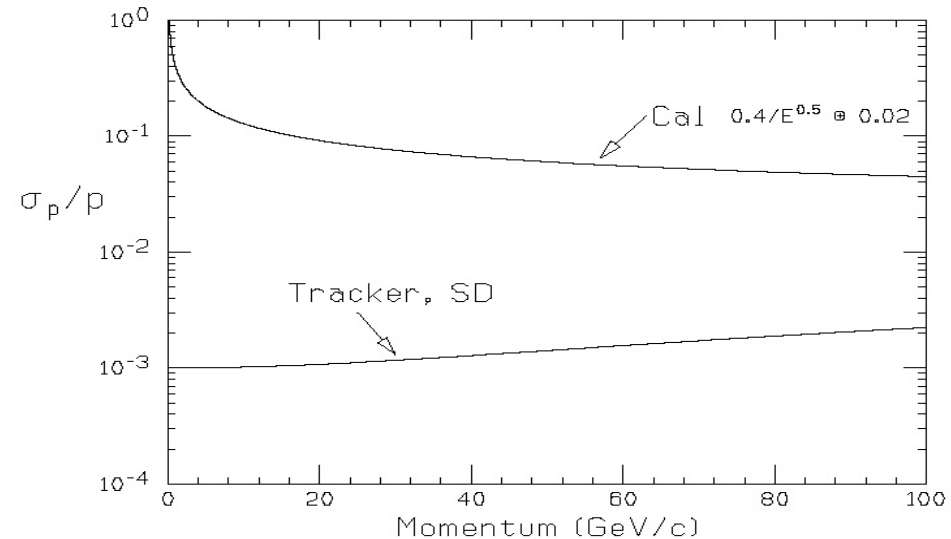
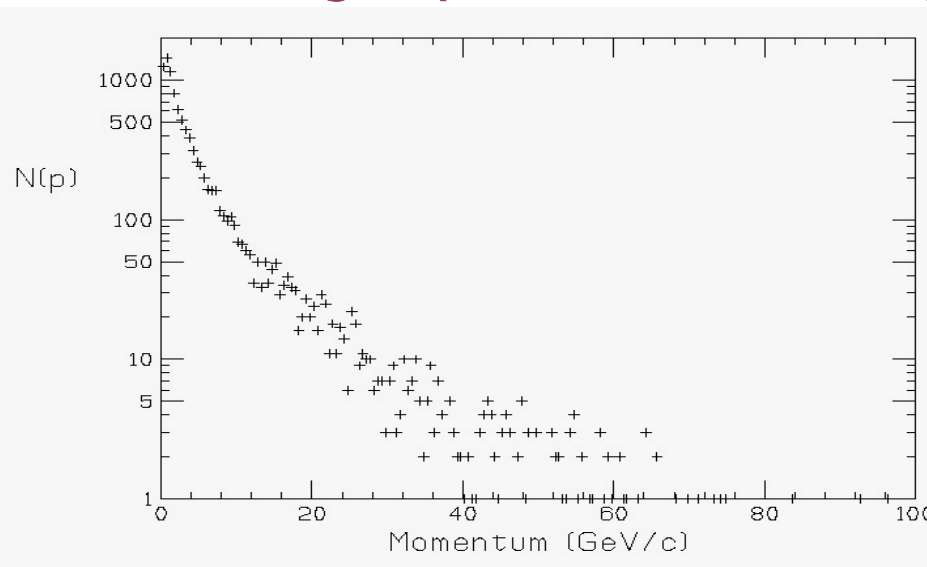

# Particle–Flow Algorithms

- To use momentum measurement from the tracker for charged particles, we must be able to separate the energy deposited by them from those by neutrals.
- Need fine 3–d granularity in the calorimetry for continued tracking.
- It helps to have the entire calorimeter inside the magnetic field so as to avoid E loss in coil dead material.
- Having the calorimeter inside the field also leads to continued bending of charged particle showers  
⇒ better charged/neutral association of hits.

# Particle–Flow Algorithms

Indeed, the net energy resolution is limited by incorrect association of hits.

The resulting “confusion” term must be kept below  $0.24\sqrt{(E/\text{GeV})}$  in order to achieve an overall target resolution of  $0.3\sqrt{(E/\text{GeV})}$ , which is necessary for effective separation of  $W$ 's and  $Z$ 's in their hadronic decay modes on an event–by–event basis in the absence of other constraints.

# Particle–Flow Algorithms

With sufficiently fine segmentation, the number of cells hit by a hadronic shower has a smaller  $\sigma/\mu$  compared to the sampled E  $\Rightarrow$  for hadron calorimetry, “digital” measurement based cell counting should be more precise than traditional analog estimation based on sampling fractions.

While cell–counting is less sensitive to absolute calibration, it is more vulnerable to noise, cross–talk. We need to understand the implications of these.

# Why (not) scintillators?

- As a technology, plastic scintillators are the most widely used active media in modern sampling calorimeters.
  - Tested and true, well understood and optimized
  - Has many highly desirable features
- New developments in cell fabrication & photo-detection help meet ILC/PFA demands
  - Fine segmentation at a reasonable cost
  - Photodetection and digitization inside detector  $\Rightarrow$  min. signal loss/distortion, superior hermeticity
- Can operate in both analog and digital modes
- Interesting challenge



# Design Considerations: PFA

- Need  $\lesssim 10 \text{ cm}^2$  lateral segmentation.
- At least  $\sim 35$  layers and  $\sim 4\lambda$  must fit in  $\sim 1 \text{ m}$ .
  - Min. inner radius driven by tracker performance.
  - Max. outer radius limited by magnet cost.
  - Min. absorber fraction limited by the need for radial containment.
- $\Rightarrow 2 \text{ cm}$  thick absorber layers if SS (less if W).
- $\Rightarrow 0.6\text{--}0.8 \text{ cm}$  sensitive layers must respond to MIPs with good efficiency and low noise.

# Design Considerations: PFA

- Good lateral containment of showers is important for minimizing the confusion term.
- W absorber in ECal  $\Rightarrow$   $e/\pi$  compensation is not built in  $\Rightarrow$  must be achieved in software  $\Rightarrow$  particle id (inside calorimeter by shower shape?) may be important.

# Design Considerations: Others

- The technology must be
  - Reliable,
  - Mechanically sound,
  - Operable inside strong magnetic field,
  - Capable of 15+ years of running,
  - Tolerant to  $\sim 5\sigma$  fluctuations in T, P, humidity, purity of gas (if any). Monitoring will be necessary if response depends strongly on any of these,
  - Suited for mass-production and assembly of millions of cells in  $\sim 40$  layers, (cont'd...)

# Design Considerations: Others

- The technology must be (...cont'd)
  - Allow hermetic construction (minimum cracks/gaps)
  - Safe (HV, gas, ...),
  - Compatible with other subsystems (MDI?),
  - Amenable to periodic calibration,
  - Able to handle the rates (deadtime  $< 0.1$  s?)
  - Cost effective (incl. construction, electronics, operation).

# Participating Institutions

- NIU: digital (1-bit)/semi-digital (2-bit), Tail-catcher, scint extrusion, simulation, PFA, TB
- DESY: analog (“tile”), FE boards, sim, PFA, TB
- LAL: VFE ASICs
- Prague: Electronics (LED calibration)
- ITEP: Instrumented tiles
- MePhi: Si PhotoMultipliers
- UK groups: DAQ, PFA
- FNAL: scint extrusion, electronics (?)
- Japan, Korea: analog (“tile”), algorithms

**Much of the effort, including beam test, is coordinated by the CALICE collaboration.**

**This report concentrates on  
efforts at NICADD/NIU.**

For more information on  
worldwide efforts, see talks  
given at LCWS05 and visit the  
CALICE scint. HCal web page.

# Hardware tests

Cells made of cast (Bicron) and extruded scintillators (NICADD/FNAL) have been extensively tested with many variations of

- Shape (hexagonal, square),
- Size, thickness
- Surface treatment (polishing, coating),
- Fibers (manufacturer, diameter, end-treatment)
- Grooves ( $\sigma$ -shaped, straight)
- Photodetectors (PMT, APD, SiPM, MRS)

# Hardware tests

- Different cell and groove shapes with extruded and cast scintillators

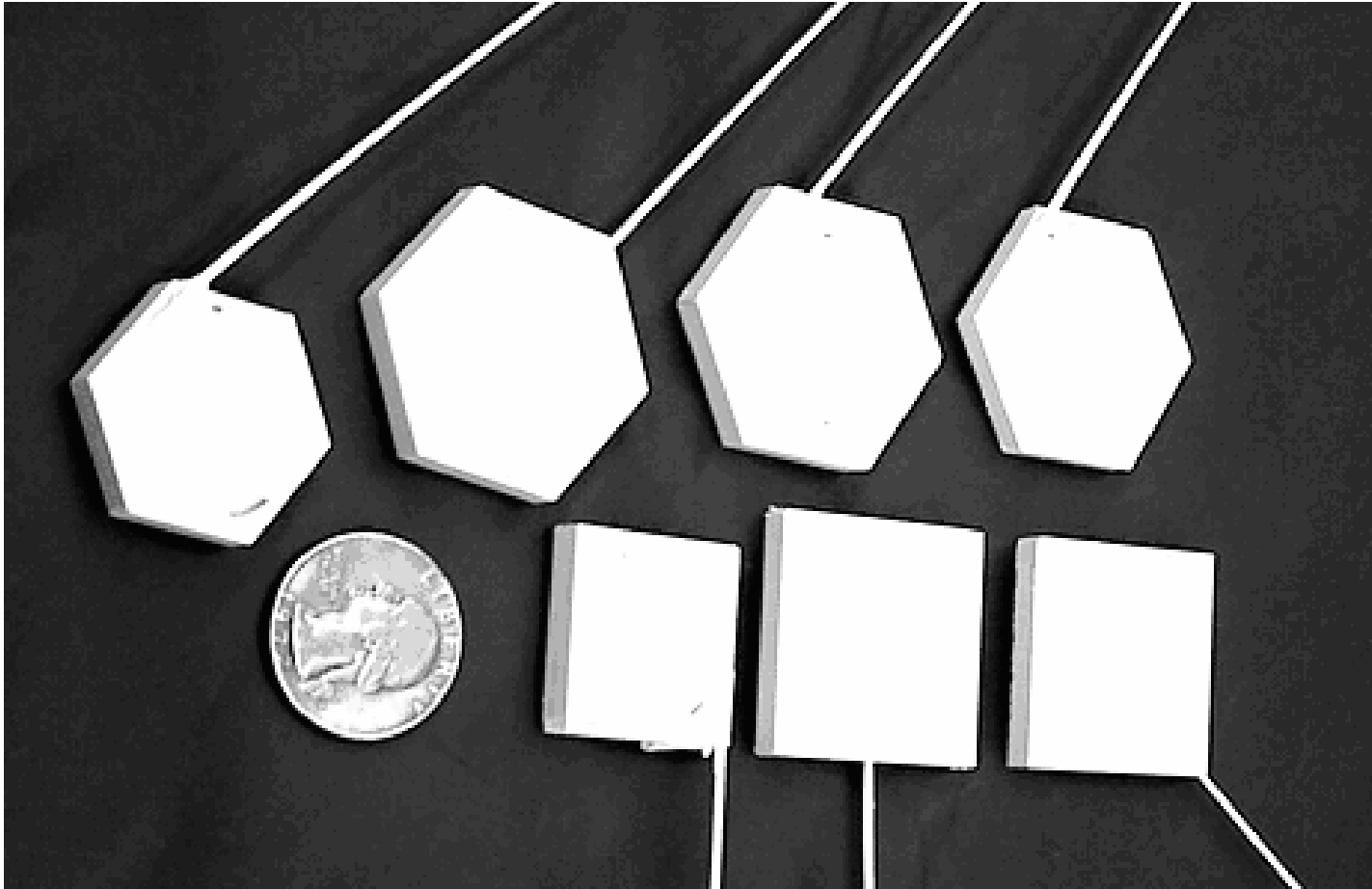



# Hardware Prototypes (NIU)

Stack, layer, and unit cell

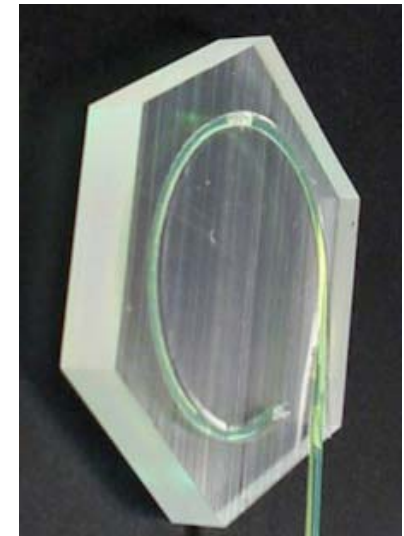
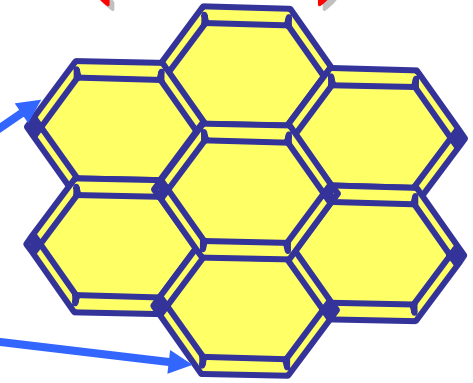
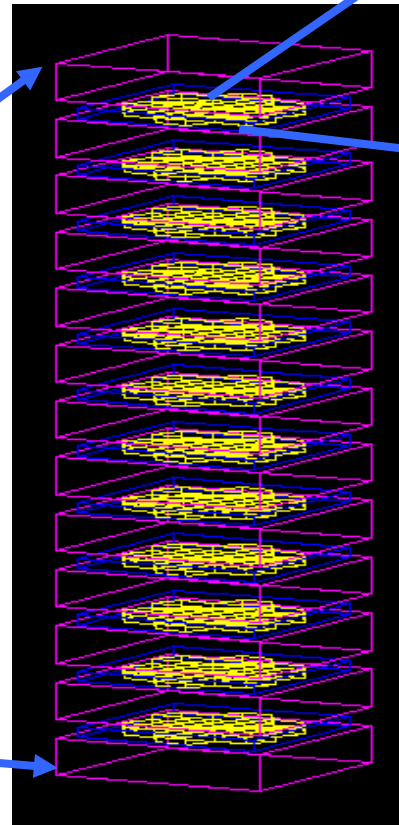
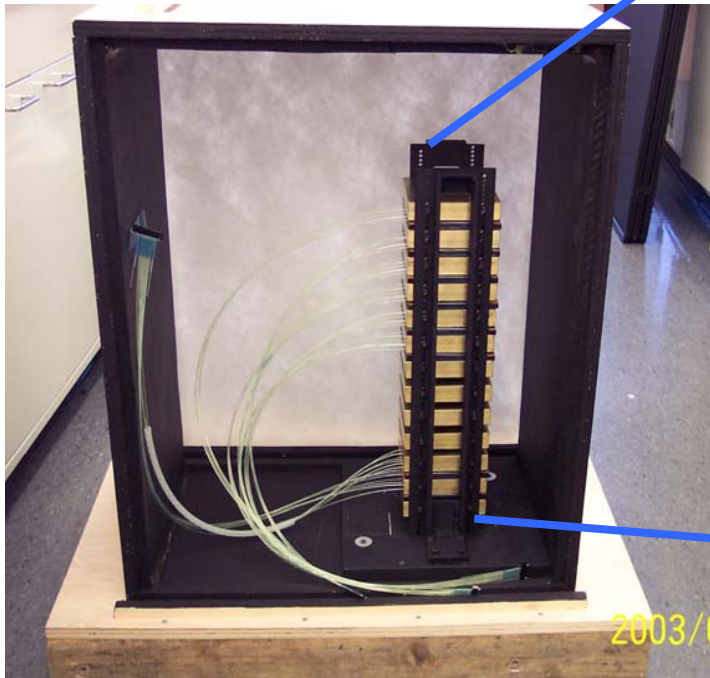

# Hardware Prototypes

## Cosmic ray data with PMT readout

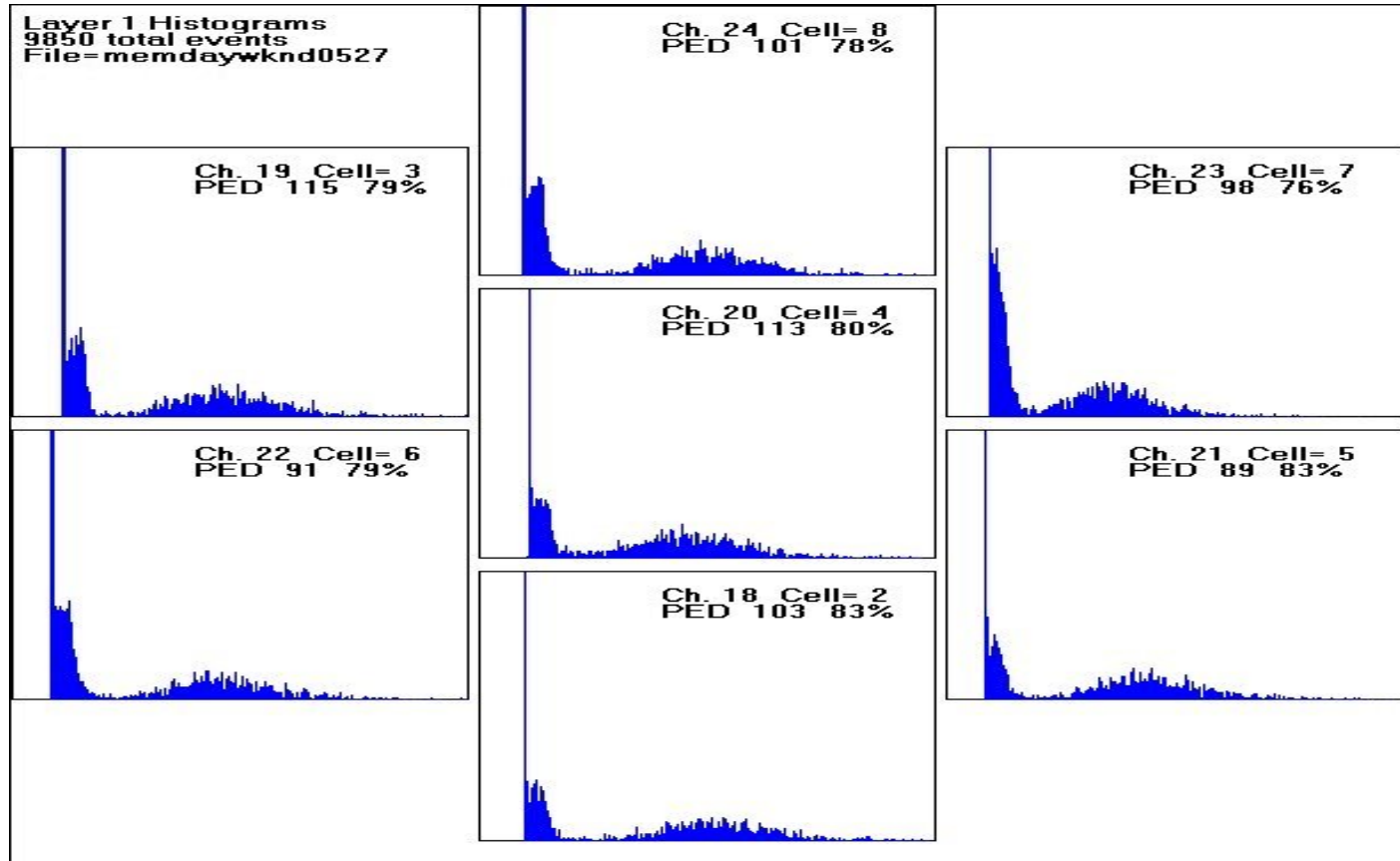

**~11 p.e. peak = 1MIP**

# Hardware Prototypes (DESY “MiniCal”)

- DESY 6 GeV e beam 2003–2004
- 108 scintillator tiles (5x5cm)
- Readout with Silicon PMs on tile, APDs or PMTs via fibres

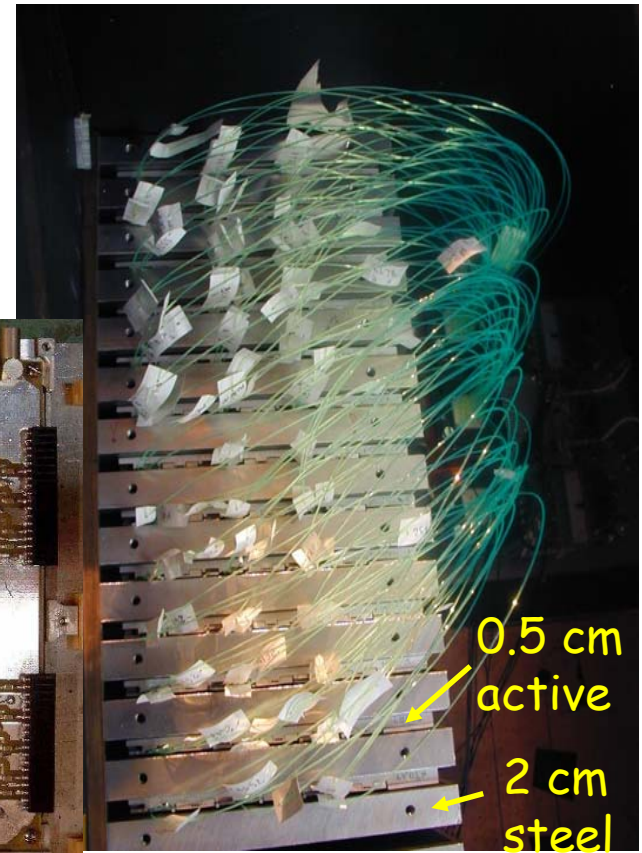
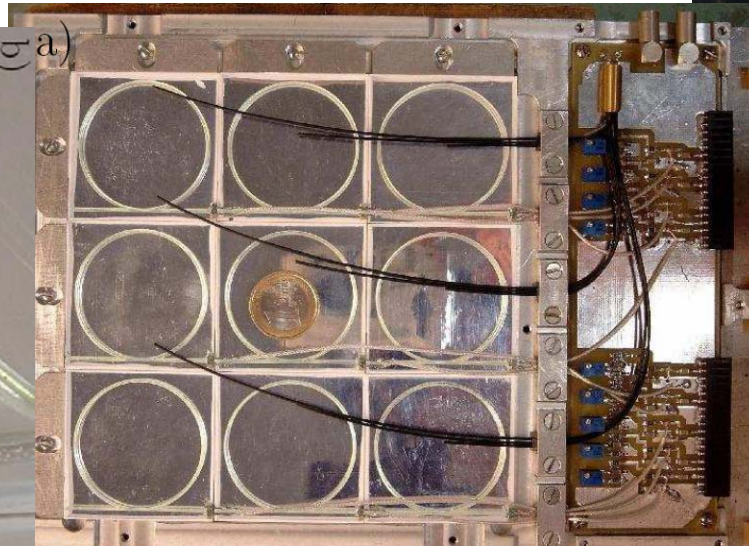

*DES Y, Hamburg U, ITEP, LPI, MEPHI, Prague*

# DESY “MiniCal” Test Beam results

- Resolution as good as with PM or APD\*
- Non-linearity can be corrected (at tile level)
  - Does not deteriorate resolution
  - Need to observe single photon signals for calibration
- Well understood in MC
- Stability not yet challenged

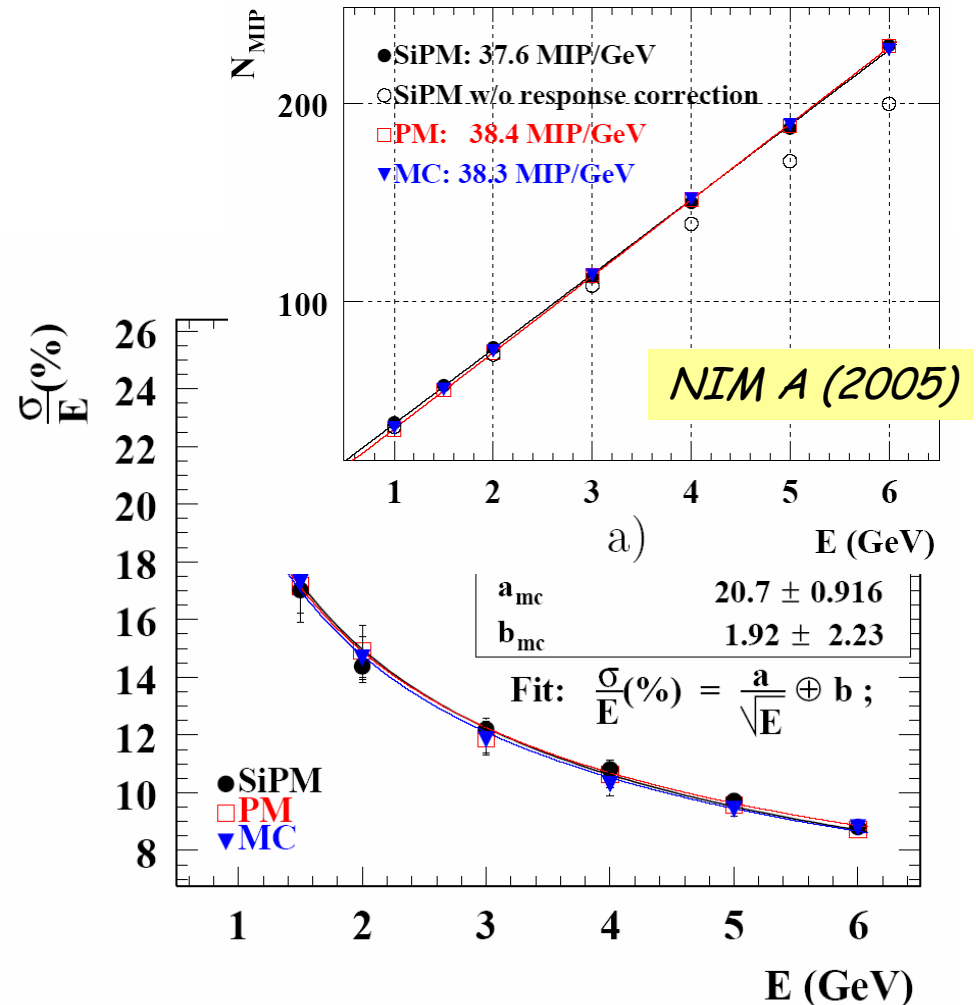

# Choosing the Optimum Threshold

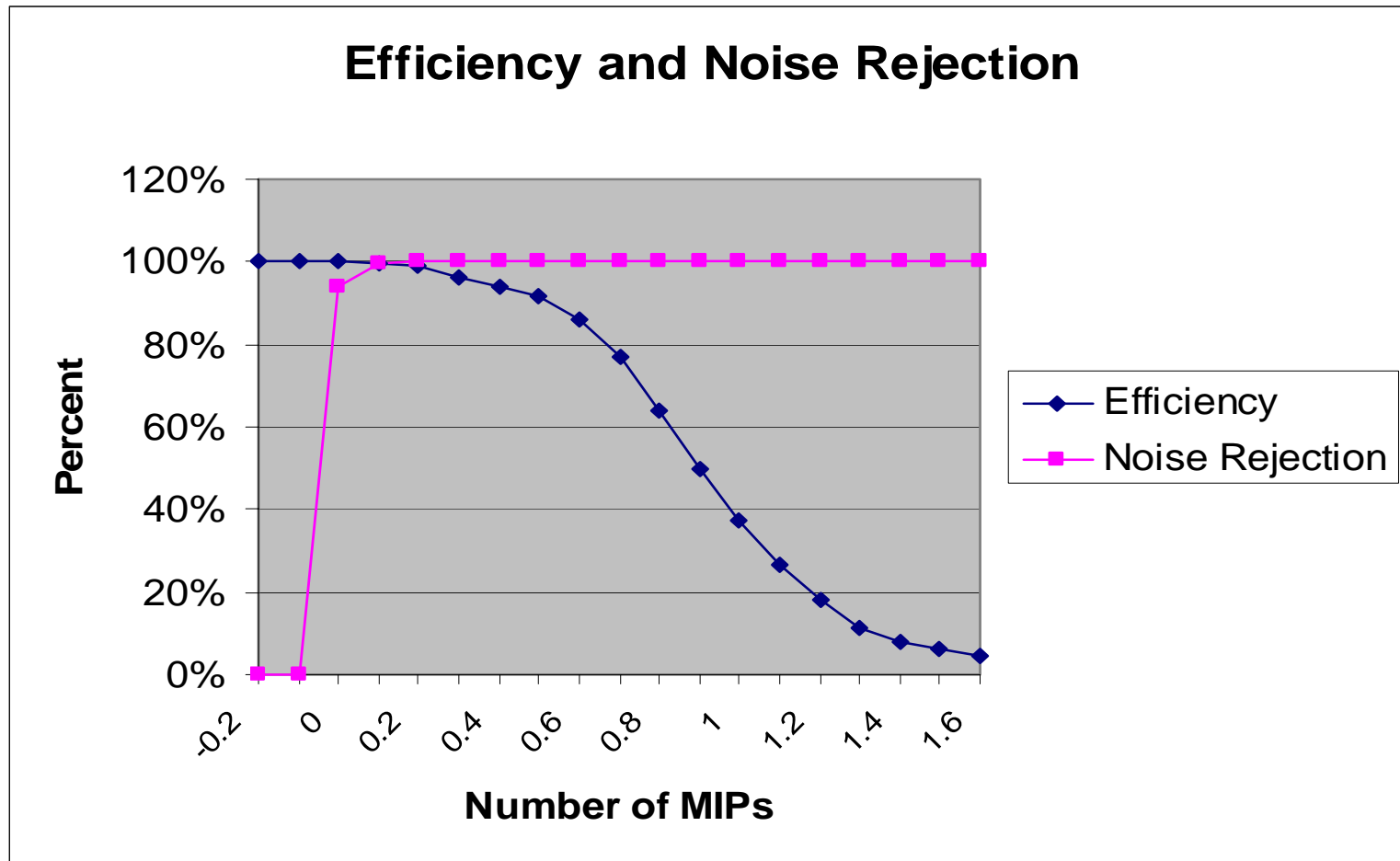

**0.25 MIP threshold: efficient, quiet**

# Cell response: uniformity & dispersion

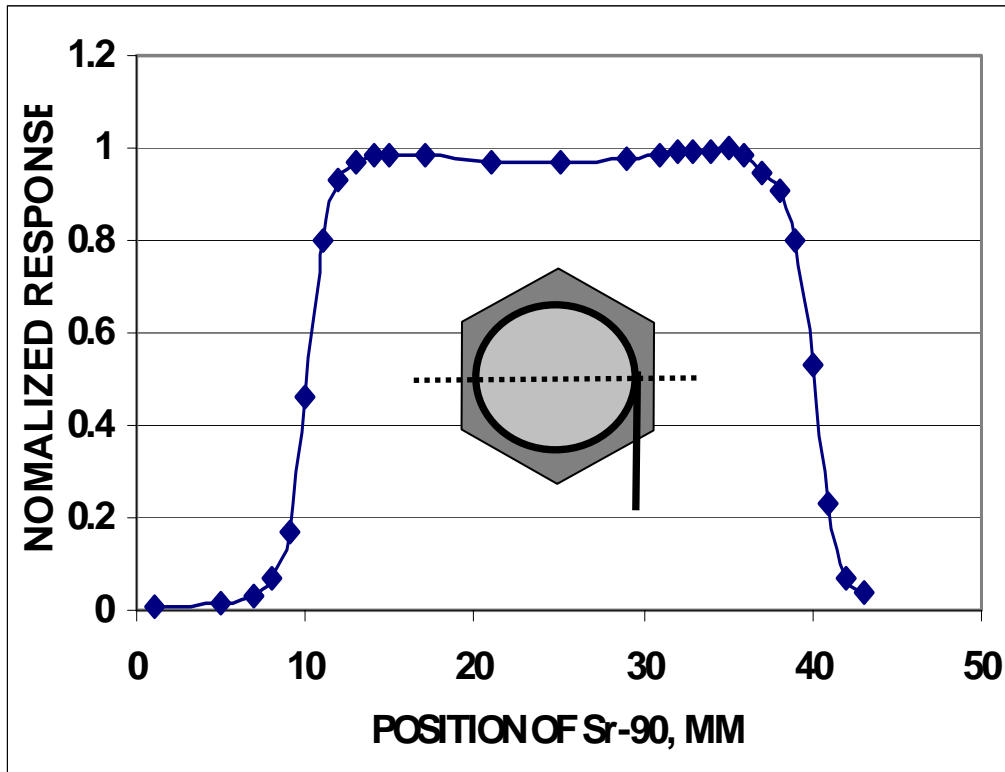

Column1	
Mean	1562.506
Standard Error	24.52647
Median	1557.96
Mode	#N/A
Standard Deviation	115.0394
Sample Variance	13234.05
Kurtosis	-0.05291
Skewness	0.334939
Range	444.52
Minimum	1386.47
Maximum	1830.99
Sum	34375.14
Count	22

Uniformity < 3%

Cell-to-cell ~7%  
(dominated by fiber)

# More uniformity measurements

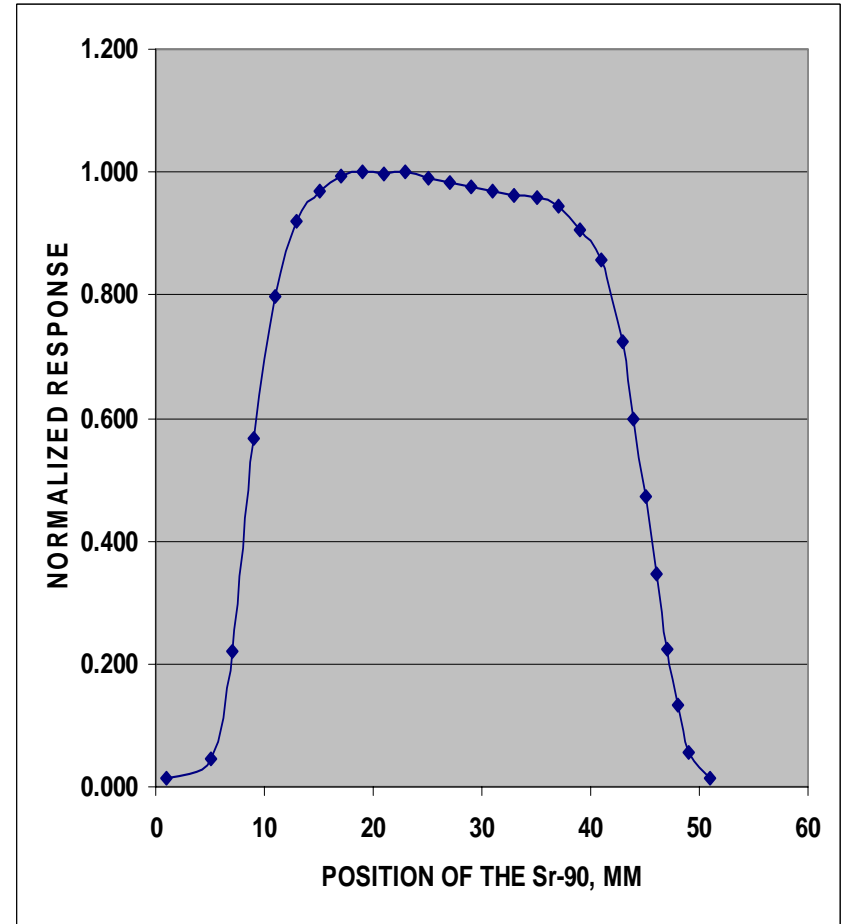
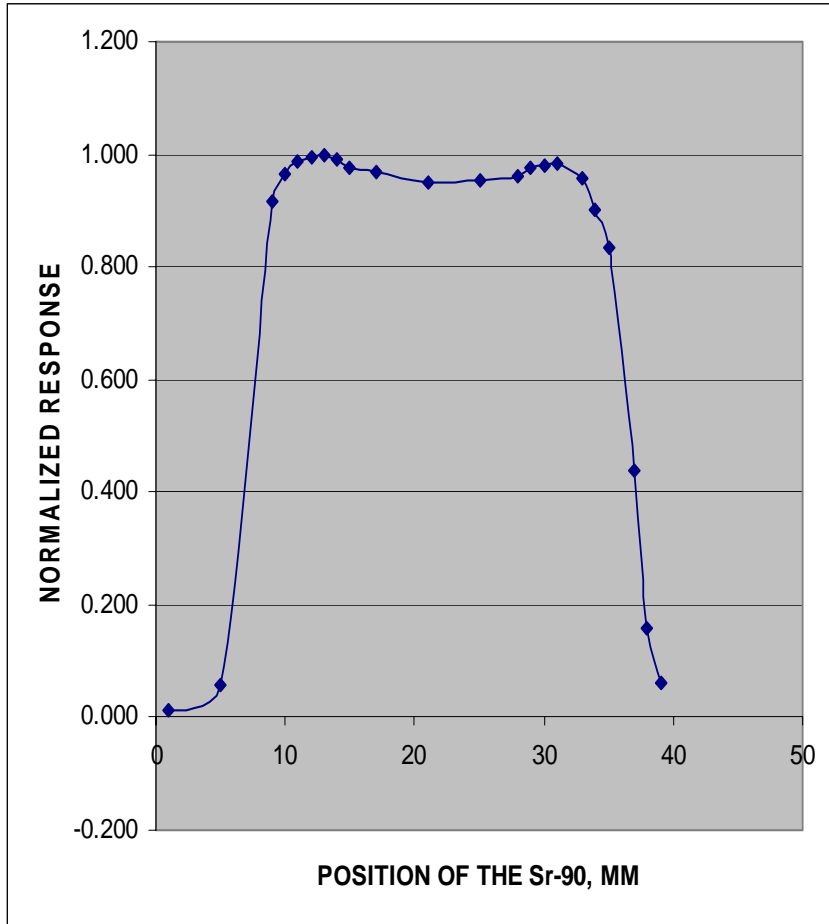

# Absolute Response measurements

(Purple: Cast, Blue: Extruded)

Cell shape	Groove	Area (cm <sup>2</sup> )	Response (nA)
Hexagon	Sigma	9.4	1895.3
Square	Sigma	9.4	1665.8
Square	Sigma	6	1740.5
Hexagon	Sigma	6	1743.8
Hexagon	Sigma	9.4	2015.9
Square	Straight	9.4	1523.4
Square	Straight	4	1618.6
Square	Straight	9.4	861.5
Hexagon	Straight	9.4	900.9
Hexagon	Sigma	9.4	1089.4

Ample light ⇒ flexibility for optimization, ease of construction



# Surface treatment/wrapping

UNPOLISHED TOP + POLISHED BOTTOM	POLISHED TOP + POLISHED BOTTOM	UNPOLISHED TOP + UNPOLISHED BOTTOM
0.98	1.00	1.02

Tyvek	Paint	VM 2002	Mylar	CM590	CM500	Al Foil
1.00	0.89	1.08	0.83	0.28	0.44	0.63

**Painting is easy, light loss acceptable**

# Miscellaneous Measurements

Response ratios between types, glues, fibers,...

- Scintillator type: extruded/cast  $\approx 0.7$
- Optical glue: EJ500/BC600  $\approx 1.0$
- Fiber: Y11/BCF92  $\approx 3.2$ 
  - Y11 = 1 mm round Kuraray,
  - BCF92 = 0.8 mm square Bicron

**Extruded/cast (cost)  $\approx 0.05$**

# The NICADD/FERMILAB Extruder

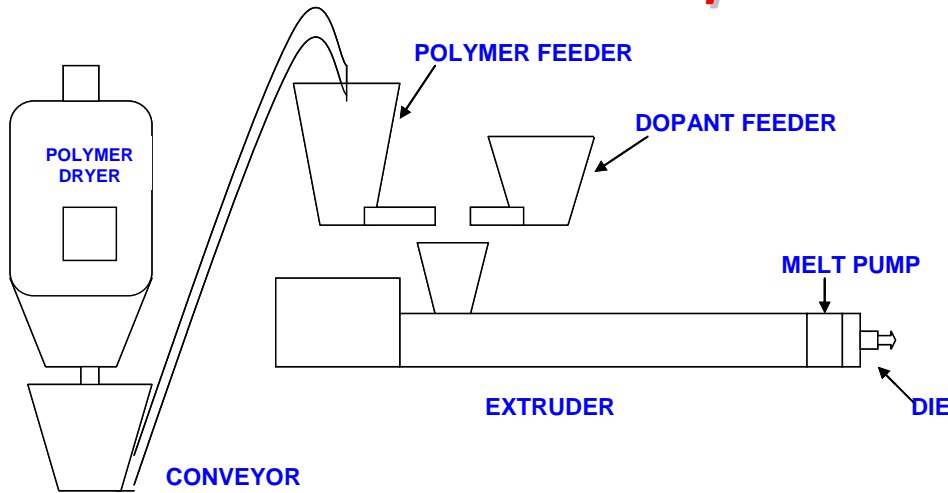

LC Study Group mtg,  
26-05-2005

Scintillator-based HCal for ILC  
Dhiman Chakraborty

# Uniformity of thickness

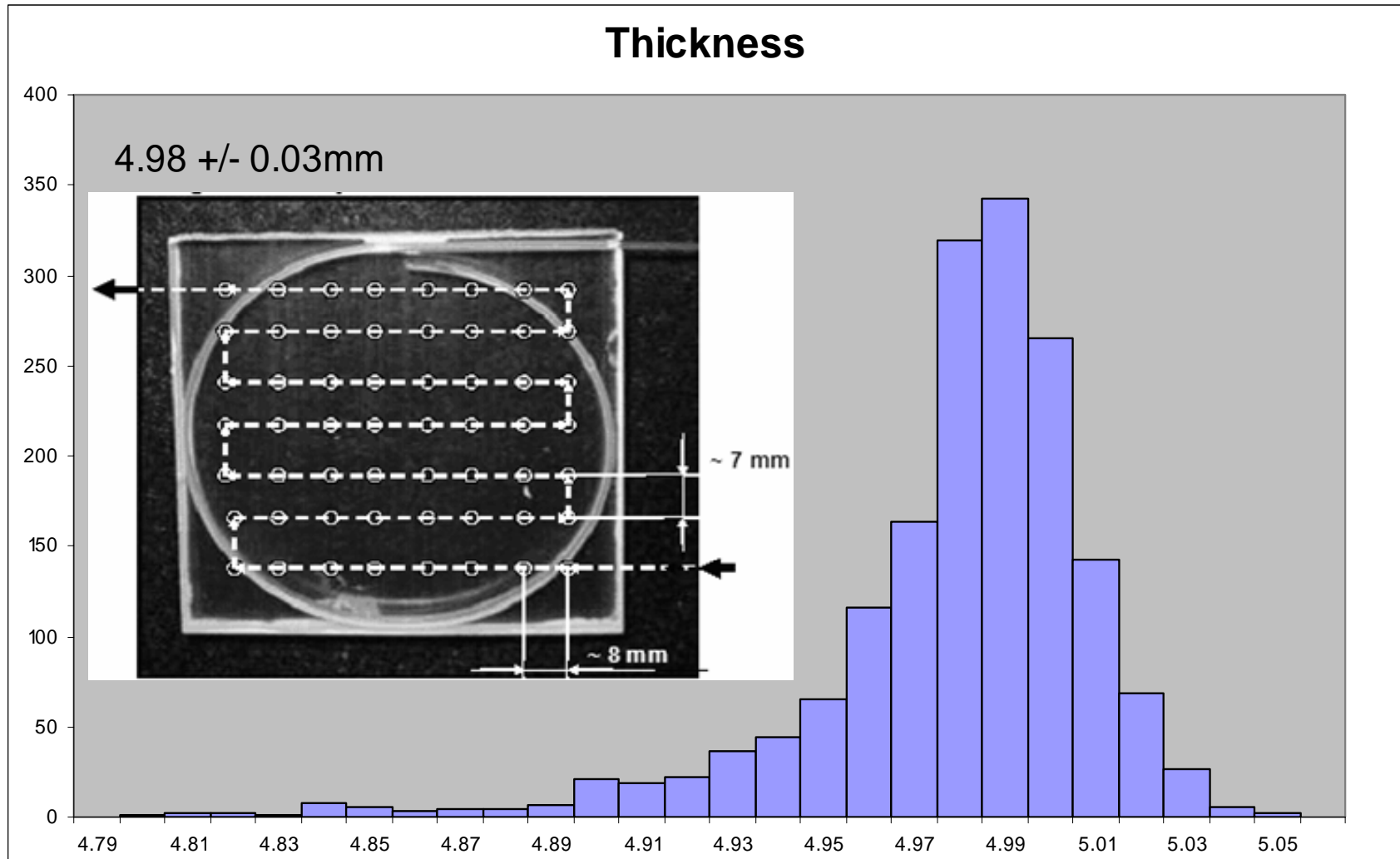

# Uniformity of thickness

$\sigma/\mu \approx O(10^{-3})$  on 5 mm: well within

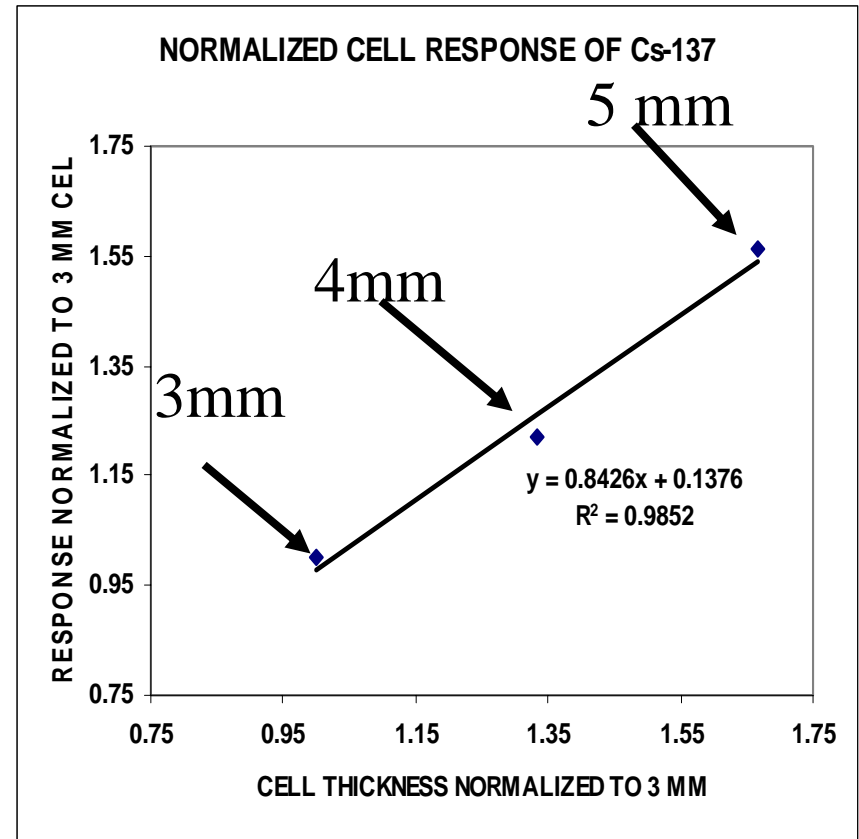
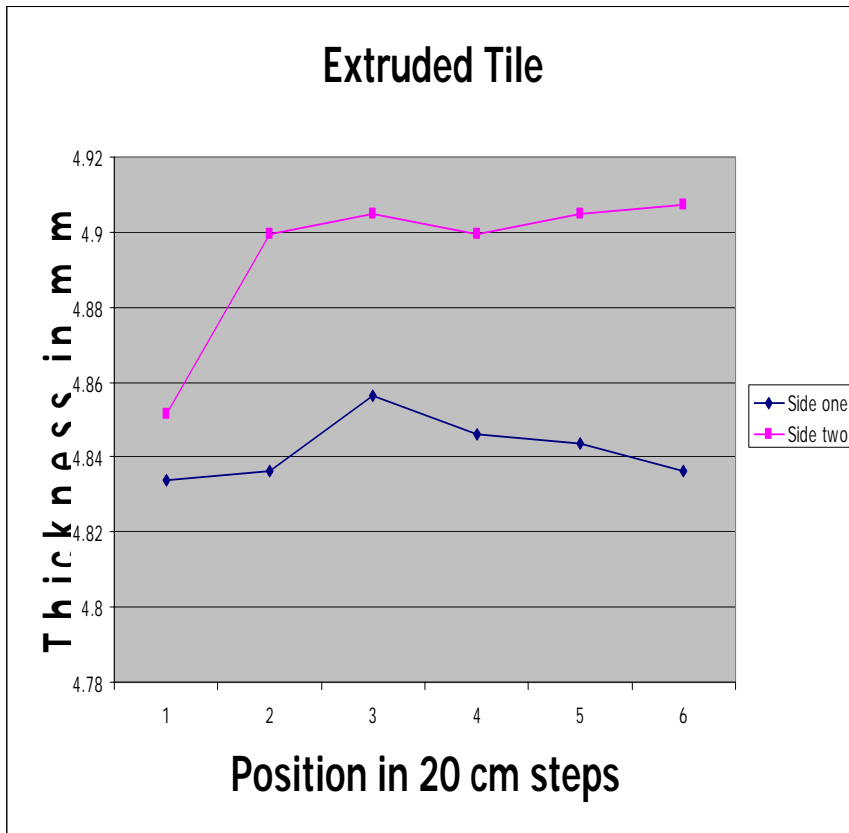

**Thickness is not an issue**

# Optimum parameters

- Shape: Hexagonal or Square
- Thickness: 5 mm
- Lateral area: 4 – 9 cm<sup>2</sup>
- Groove: straight
- Fiber: Kuraray 1 mm round (or similar)
- Fiber Glued, Surface Painted
- Scintillator type: Extruded

Based on what we have learnt so far

**But a bigger question is the photodetector:**

PMTs are costly, bulky (won't operate in B field anyway)

**We have been investigating APDs, MRS, Si-PM...**

# Avalanche Photo-Diodes

Hamamatsu APD gain vs V @ diff wavelengths (T= 18 °C)

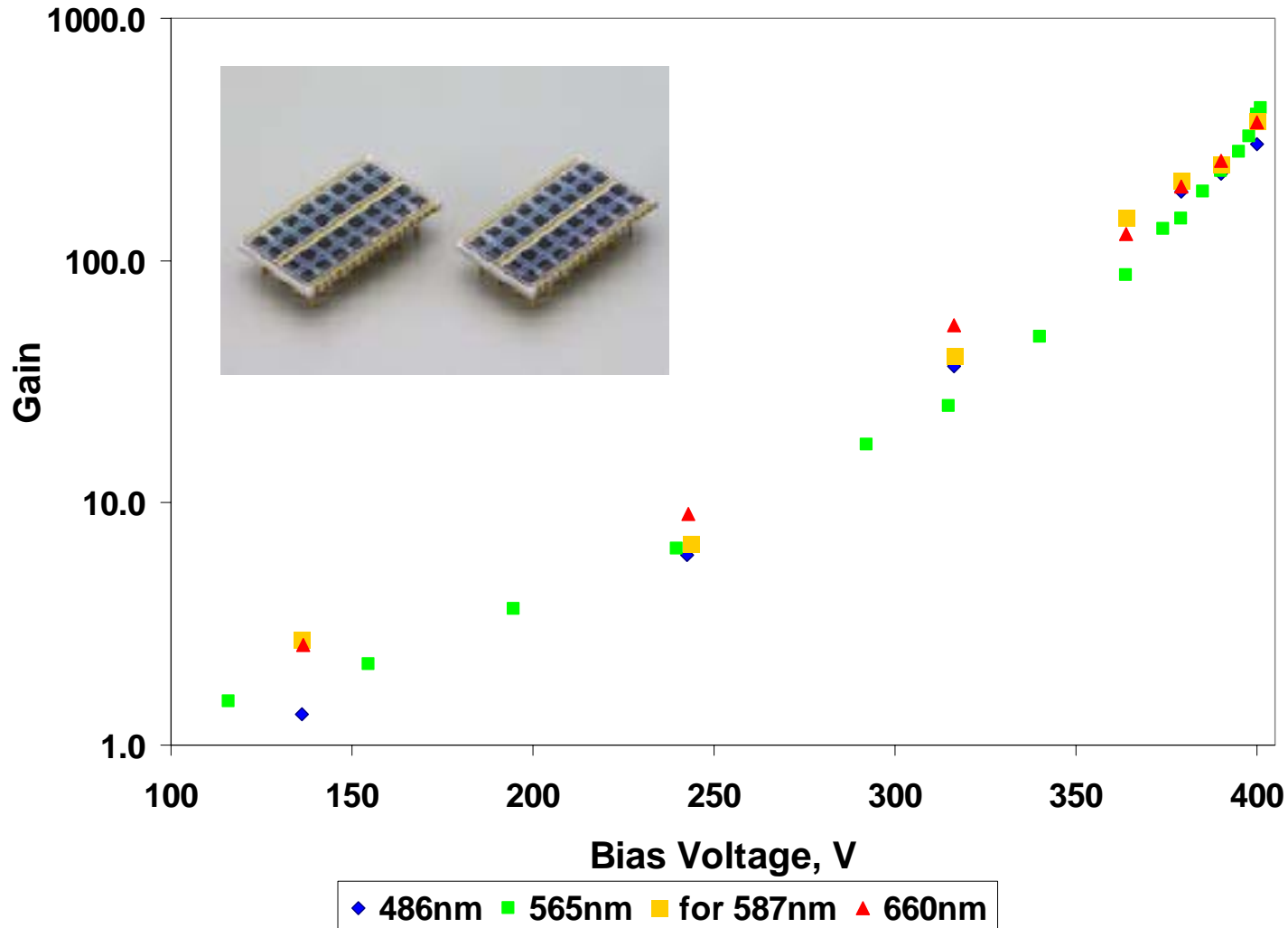

# Cosmic MIP detection with APDs

5 mm cast scintillator read with Hamamatsu S8550 APD

Bias = 393 V, Signal width  $\approx$  100 ns, amplitude  $\approx$  8 mV, noise  $\approx$  2 mV

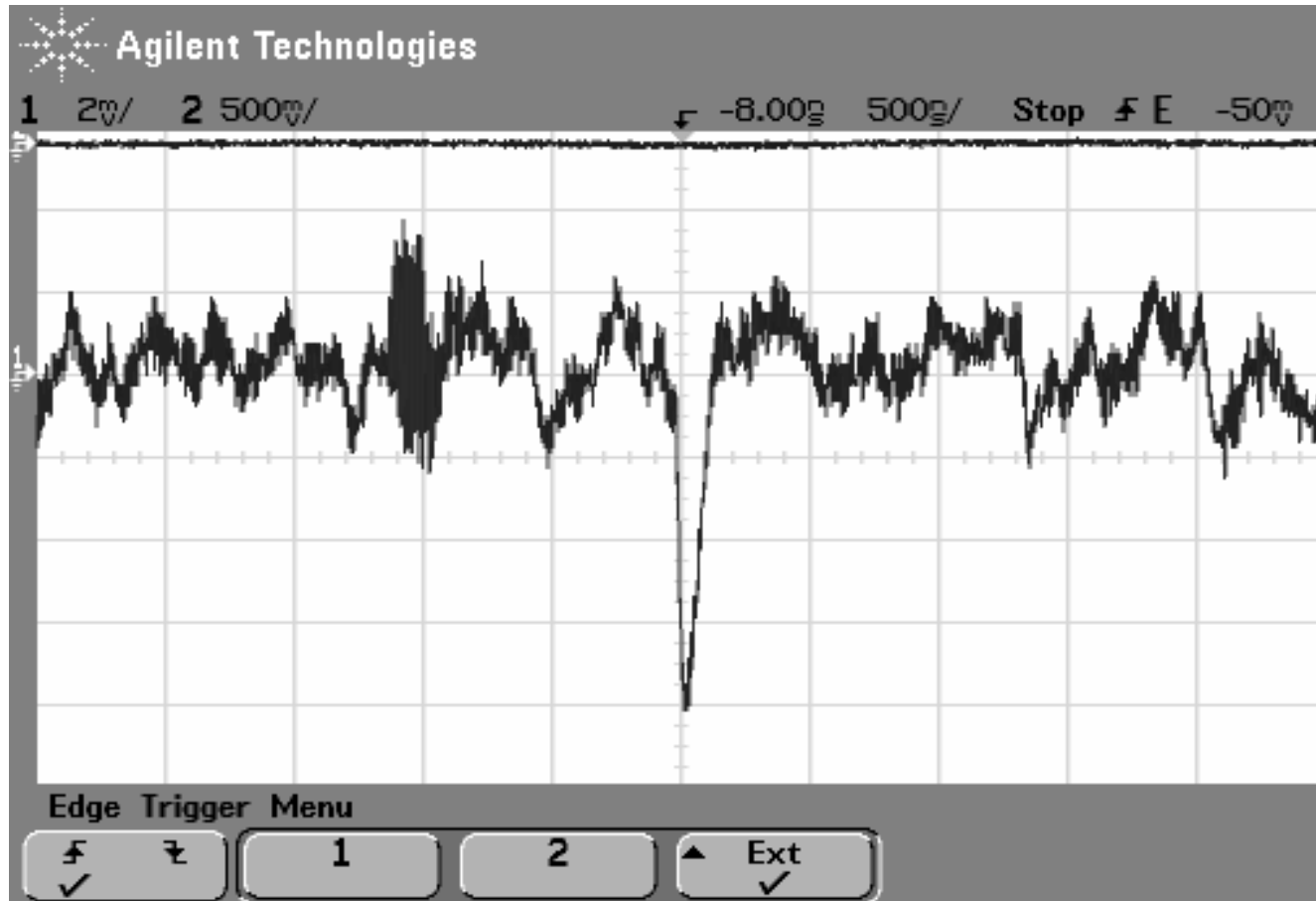



# Metal Resistive Semiconductors (MRS)

- From the Center of Perspective Technologies and Apparatus (CPTA, Russia)

## Typical pulseheight spectrum

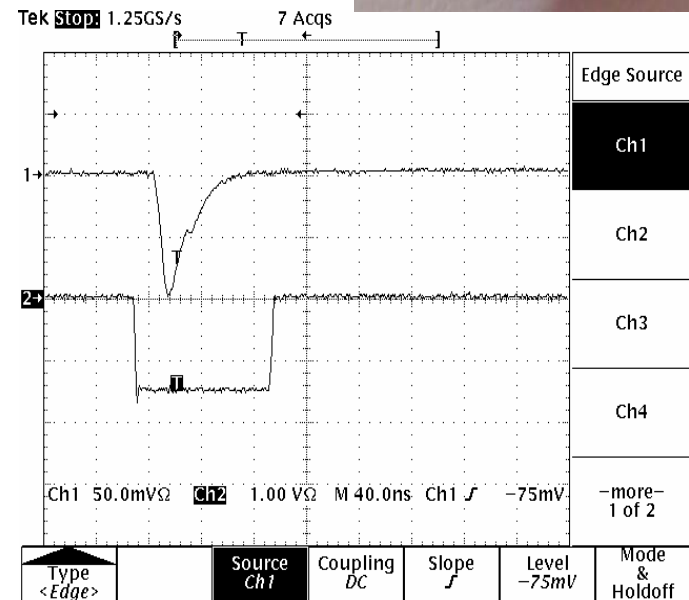
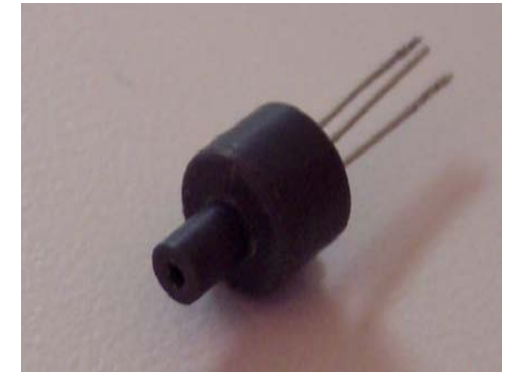
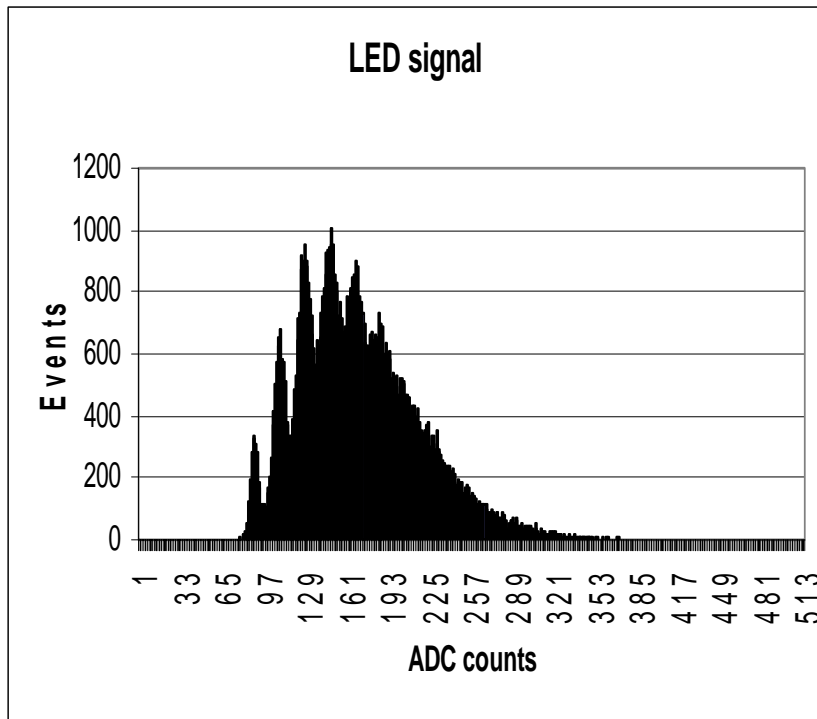

# Cosmic MIP detection with MRS

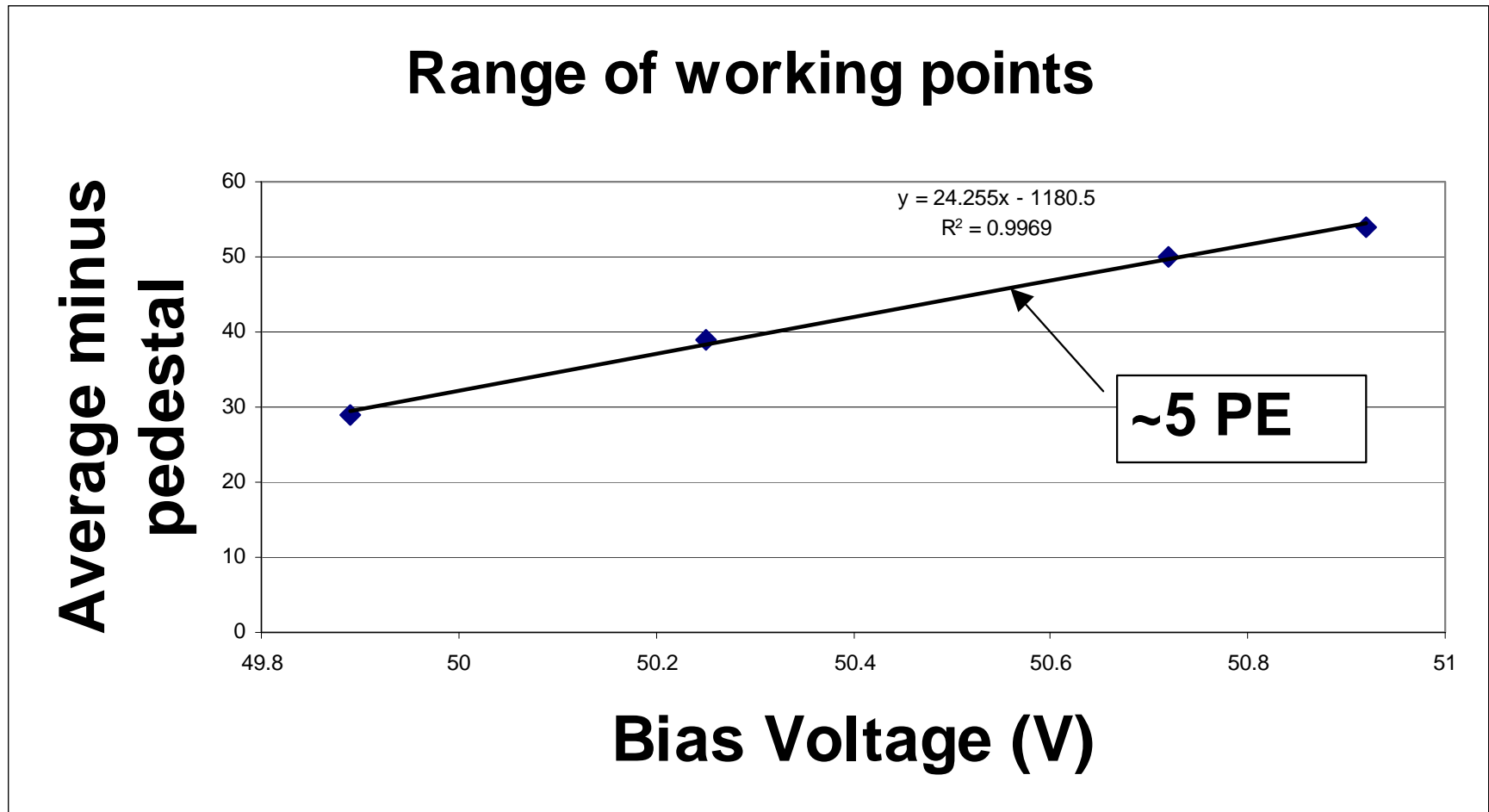

# Silicon Photomultipliers (SiPM)

- From Moscow Engineering Physics Institute (MEPhI, Russia)

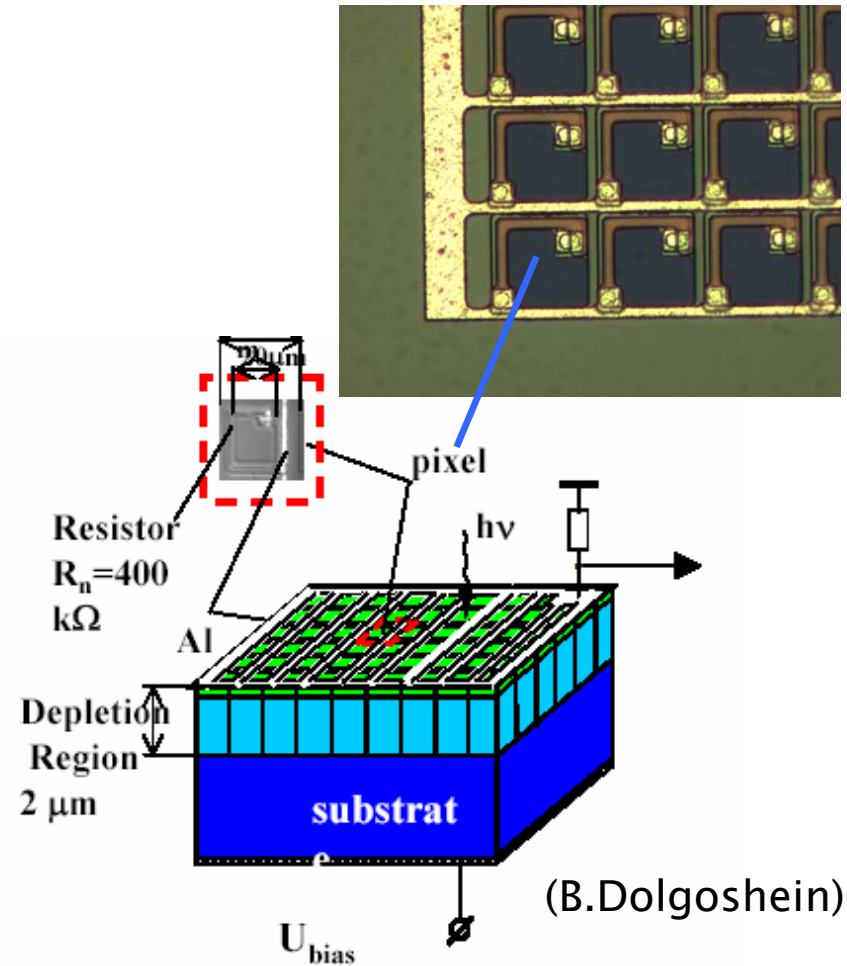
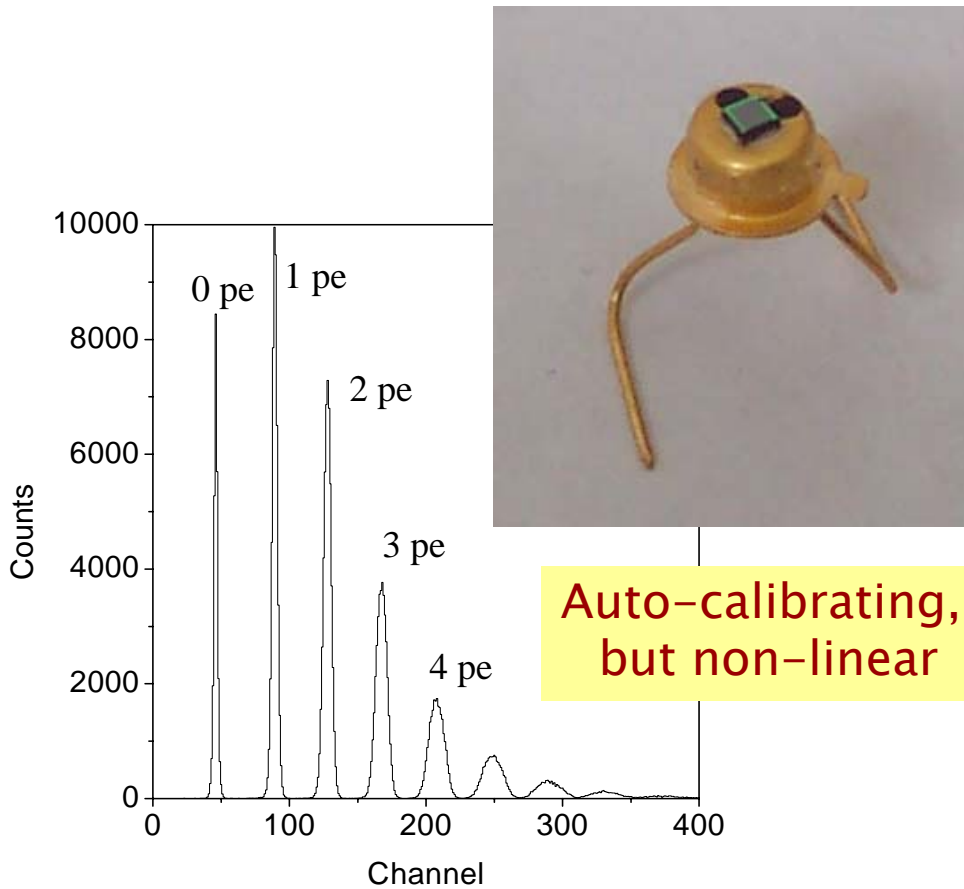

# Silicon Photomultipliers (SiPM)

## Typical pulseheight spectrum

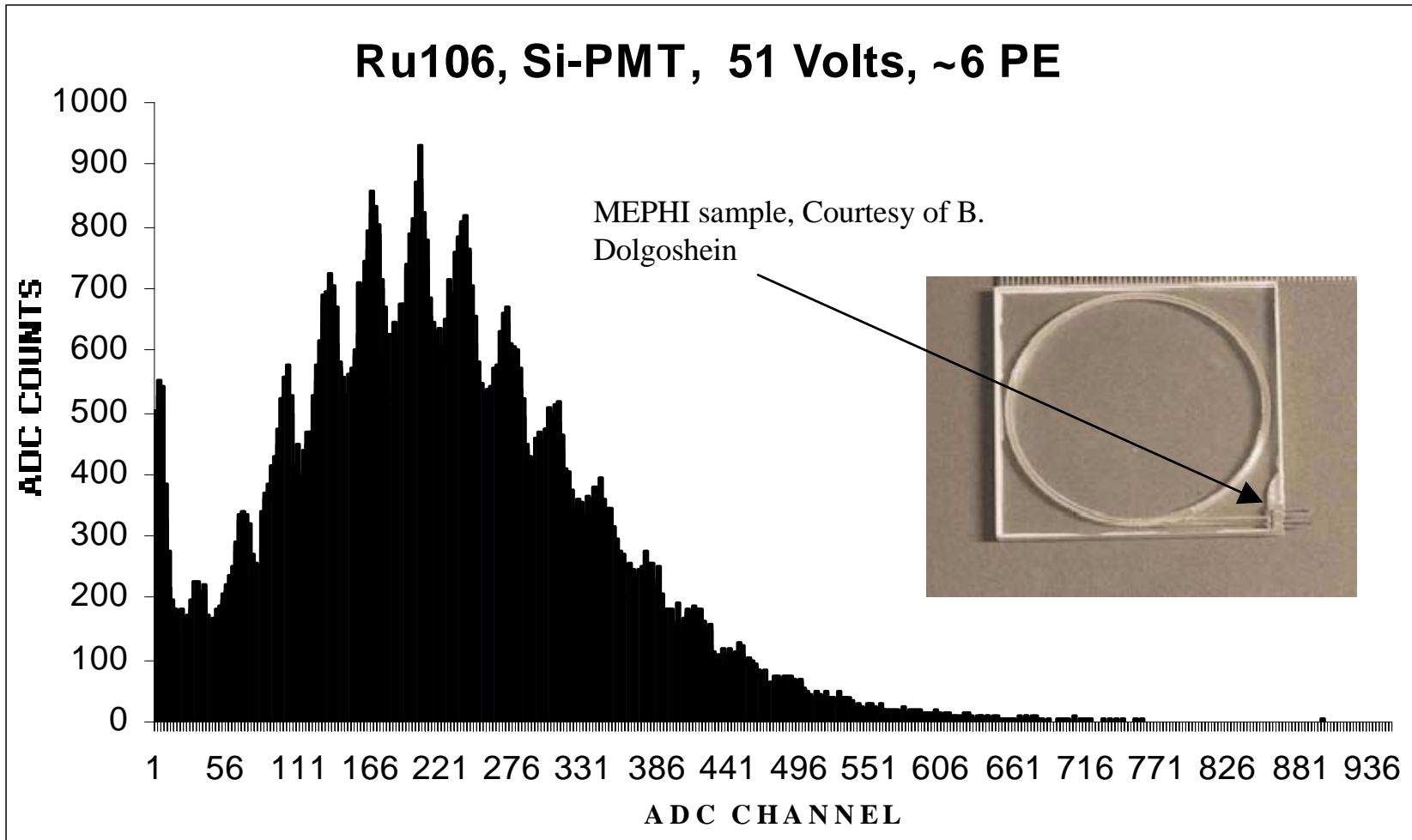

# Cosmic MIP detection with SiPM

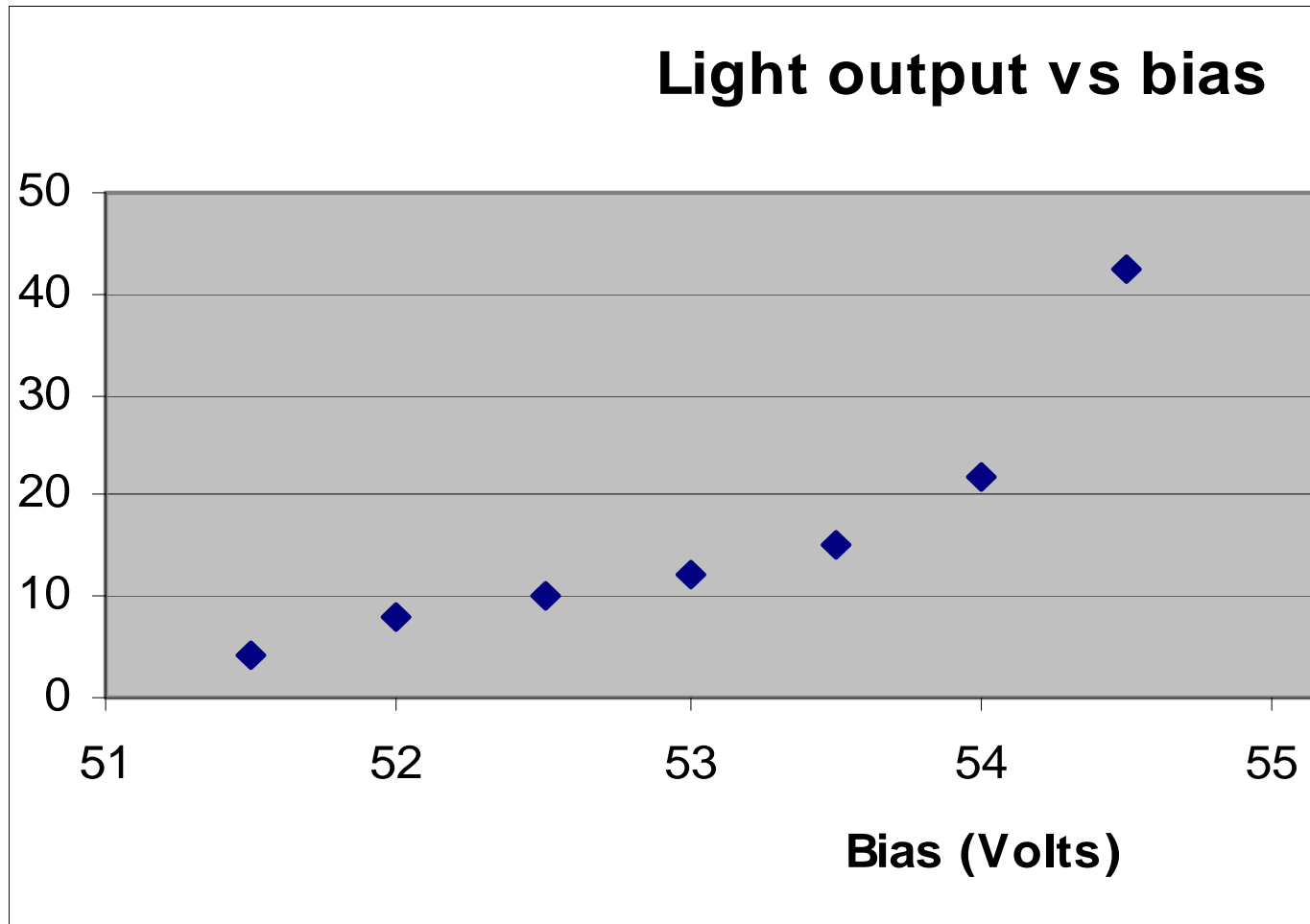

**Comparable to PMT**

# Photodetector Characteristics Summary: Specs/Test Results

Device	HAMAMATSU APD	VLPC	SiPM or MRS	PMT
Photo Electrons/ MIP	>30 (by specs)	>30	<b>&gt;10</b>	<b>&gt;10</b>
Gain	400 ?	10E(5)	10E(6)	10E(6)
APD output Charge (fC)	3	768	1152	1152
S/N <sub>(room T)</sub>	~ 5.5 Est. ~ 3 real ~ 8.1 (10°C)	>10 (9K) meas. *	~ 8meas.**	> 10 meas.***

\* A. Bross et al., Fermilab FN-0733, 2003

\*\* B. Dolgoshein, "An Advanced Study of Silicon PM", ICFA IB, 2002

\*\*\* V. Rykalin, NICADD presentation, <http://nicadd.niu.edu>, 2002

**Estimate <\$10 channel in bulk for Extruded/SiPM**

# Simulation Studies

## Geometries considered

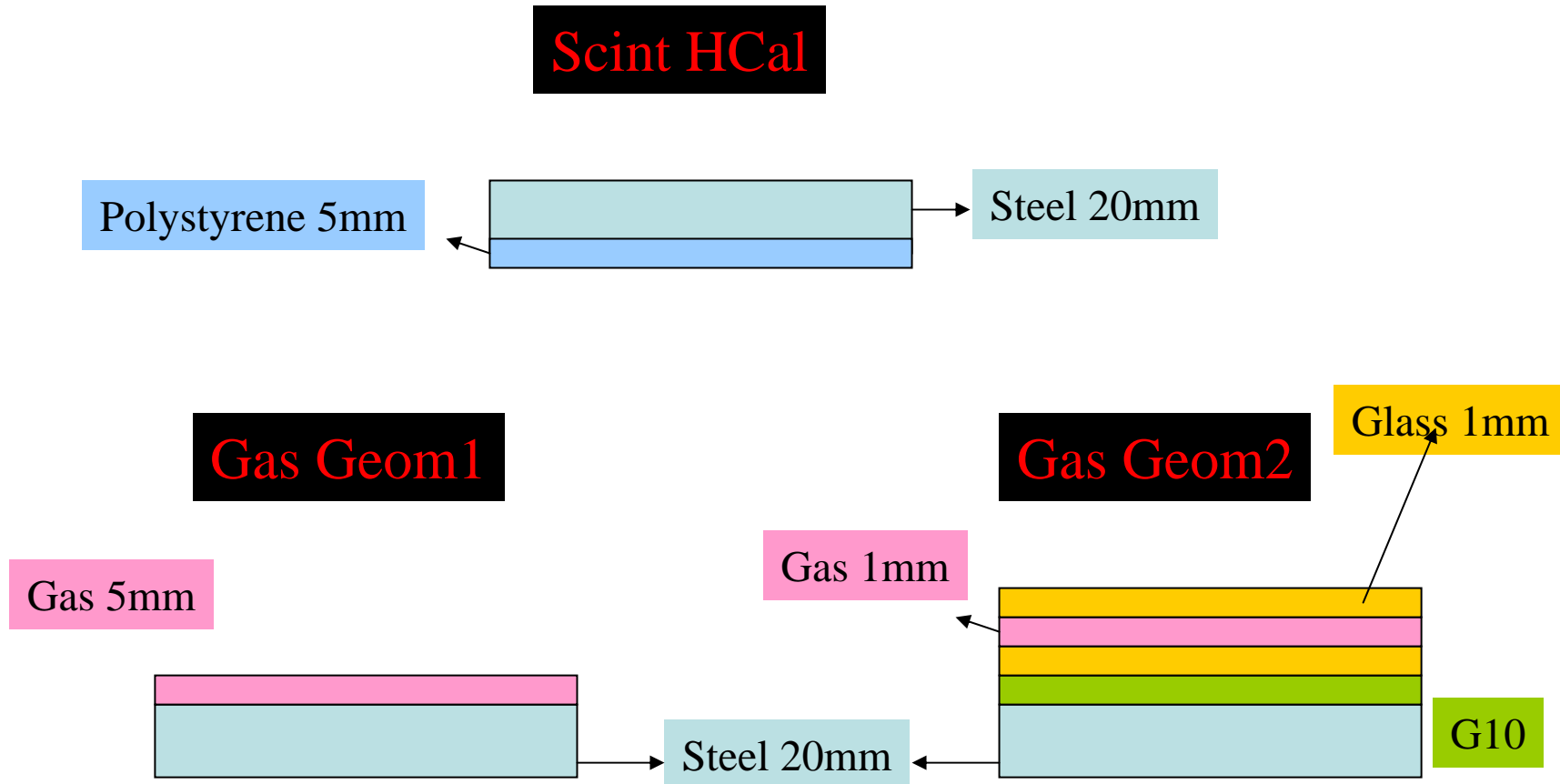

# Number of cells hit by $\pi^+$ s of 2, 5, 10, 20, 30, 50 GeV

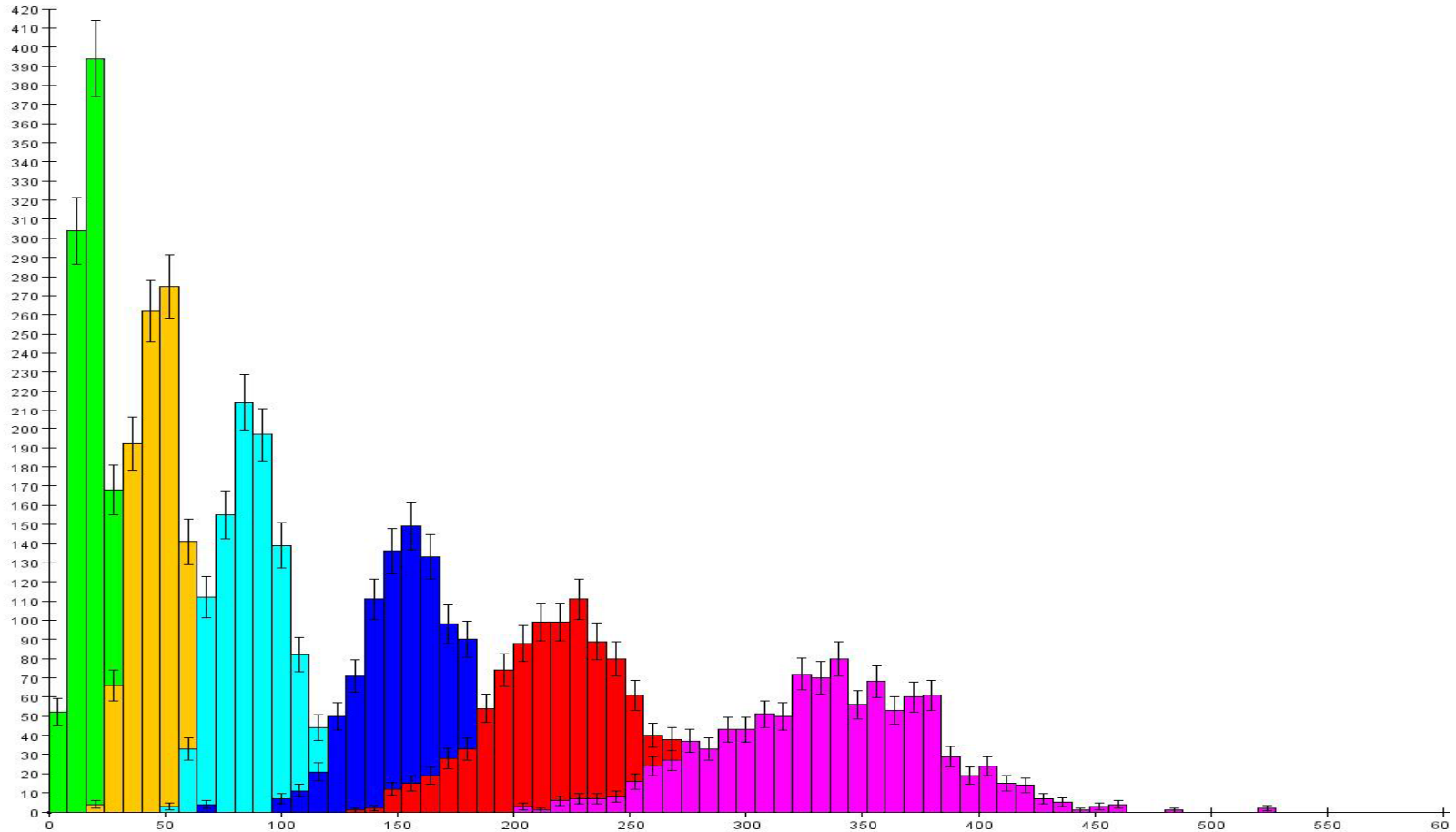



# $\pi^+$ energy resolution as function of energy for different (linear) cell sizes

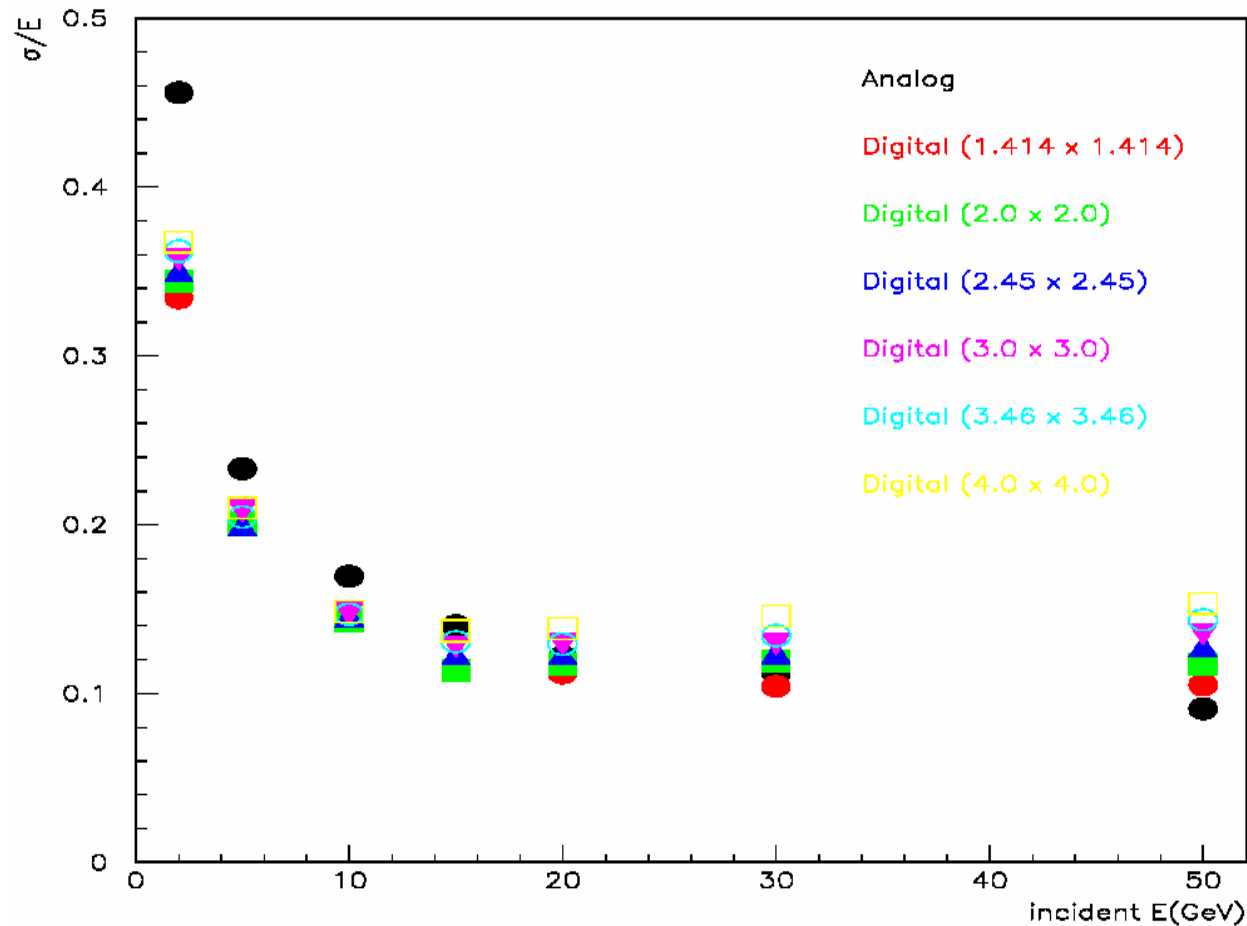

# Energy resolution for 10 GeV $\pi^+$ s

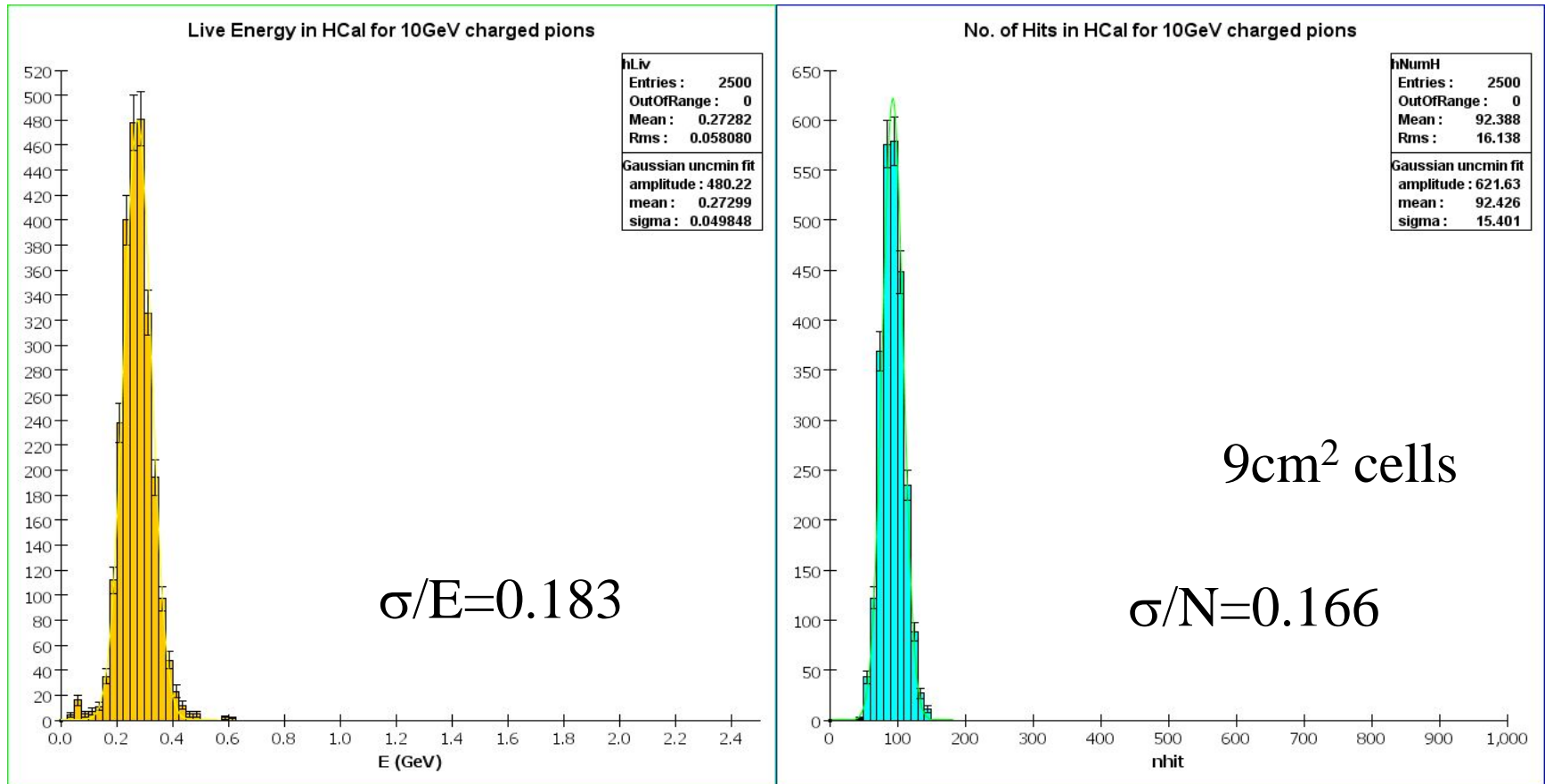

# Energy resolution for 50 GeV $\pi^+$ s

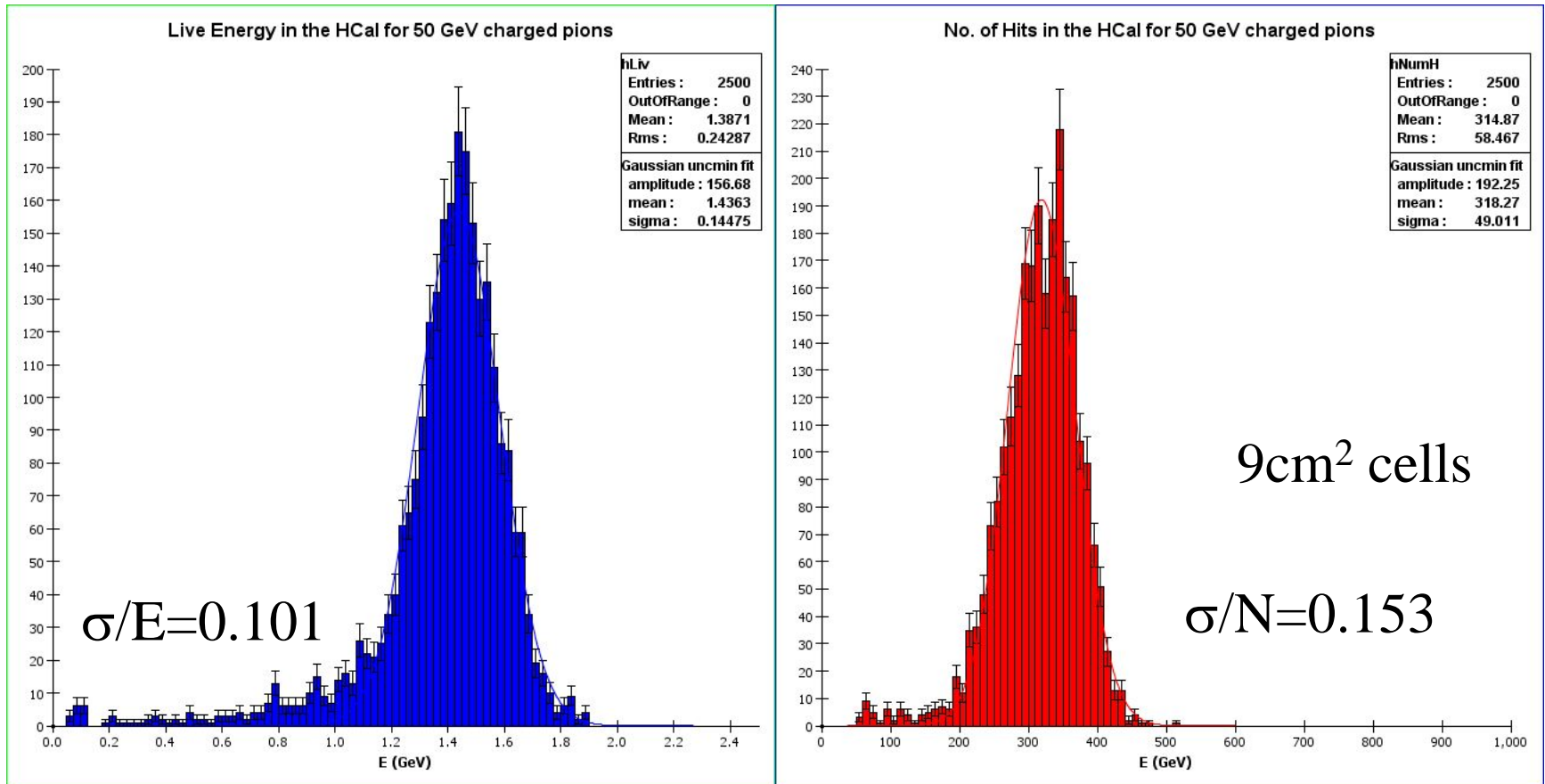

# Nhit correlations for different cell energy thresholds

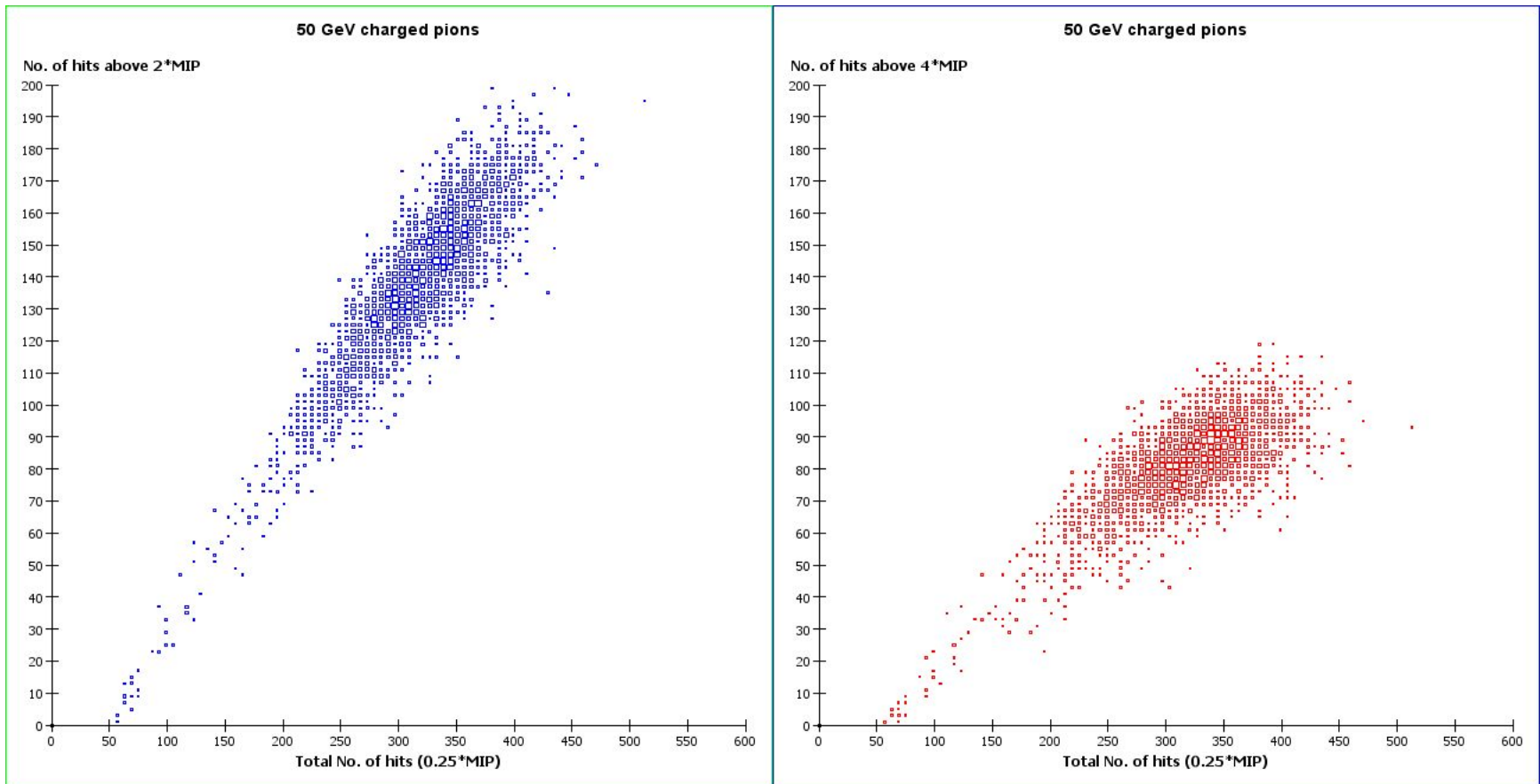

# Nhit correlations for different cell energy thresholds

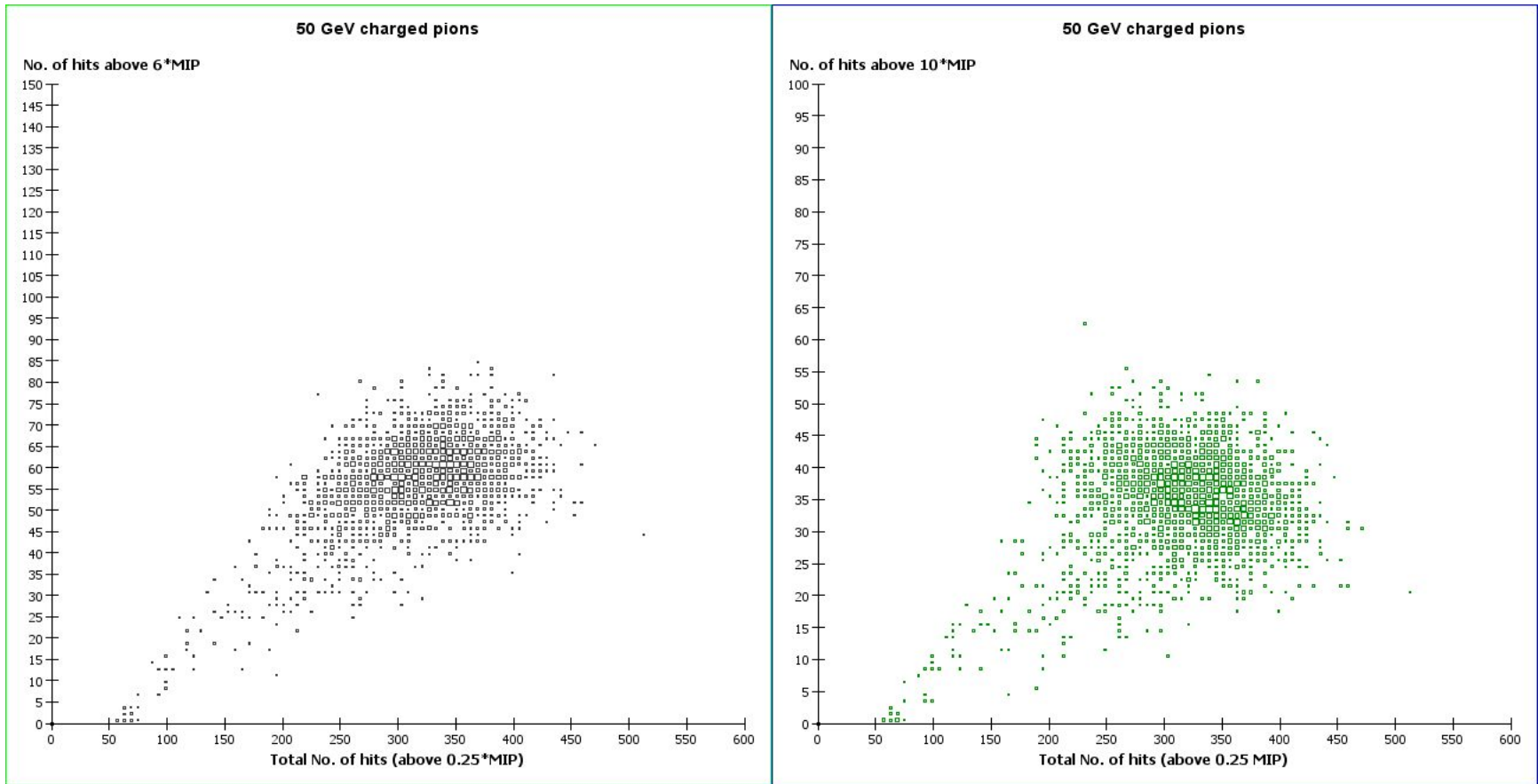

# Nhit correlations for different cell energy thresholds

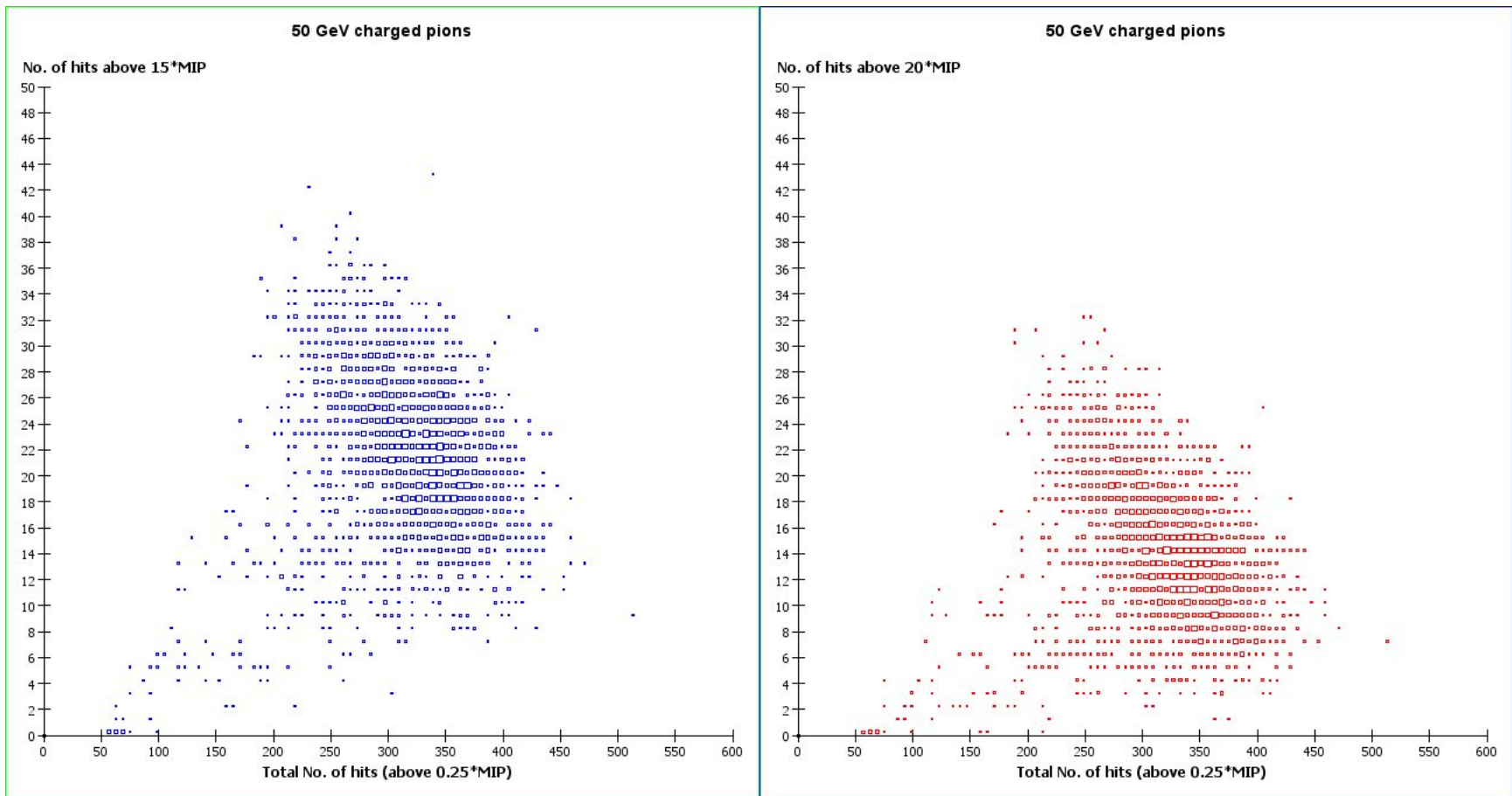

# Alternatively,

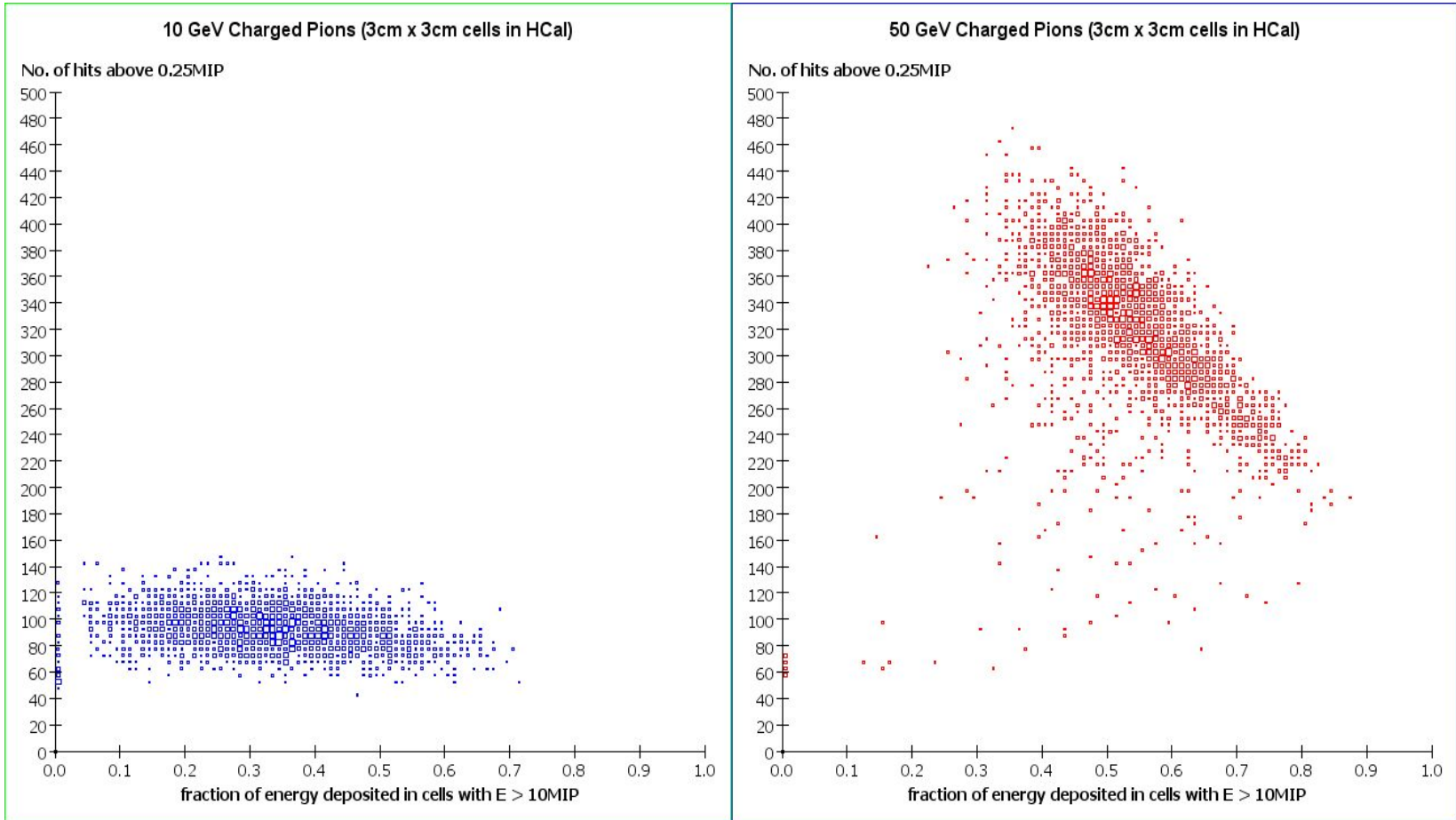

# Compensation

- Cell counting has its own version of the compensation problem (in scintillators).
- With multiple threshold this can be overcome by weighting cells differently (according to the threshold they passed).
- In MC, 3 thresholds seem to be adequate



# After semi-digital treatment

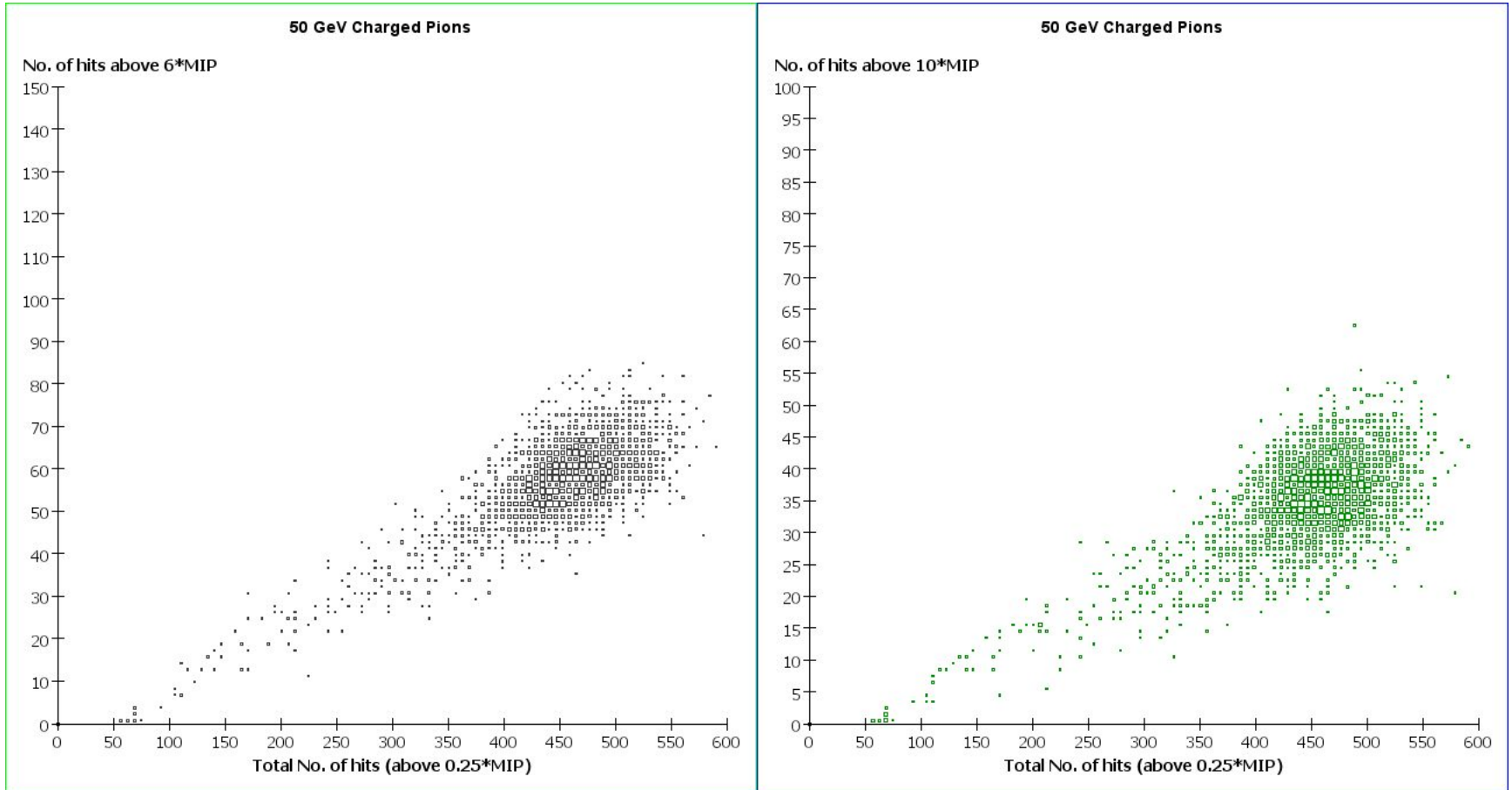

# Energy resolution: 50 GeV $\pi^+$ s

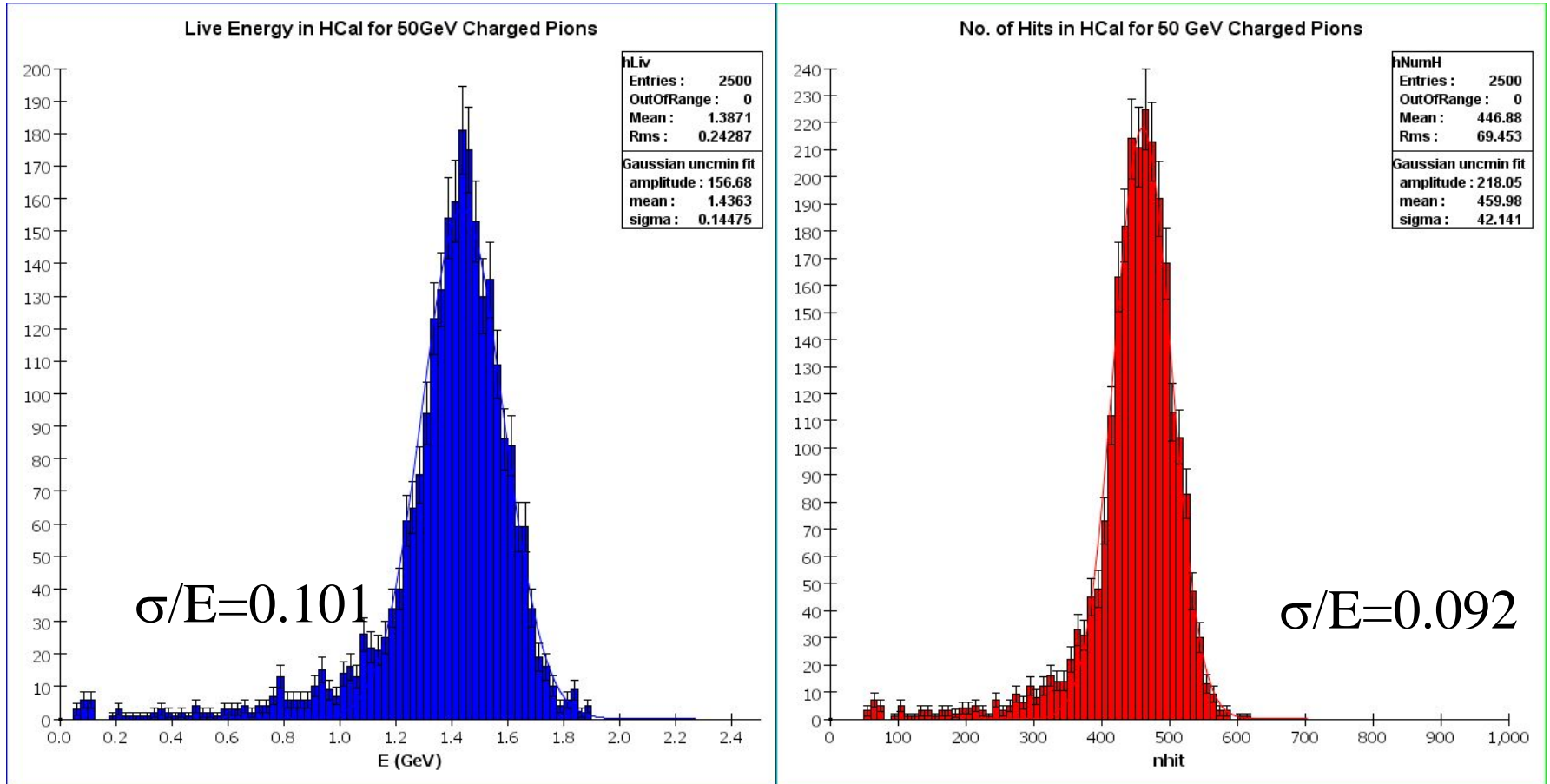

# Energy resolution: 10 GeV $\pi^+$ s

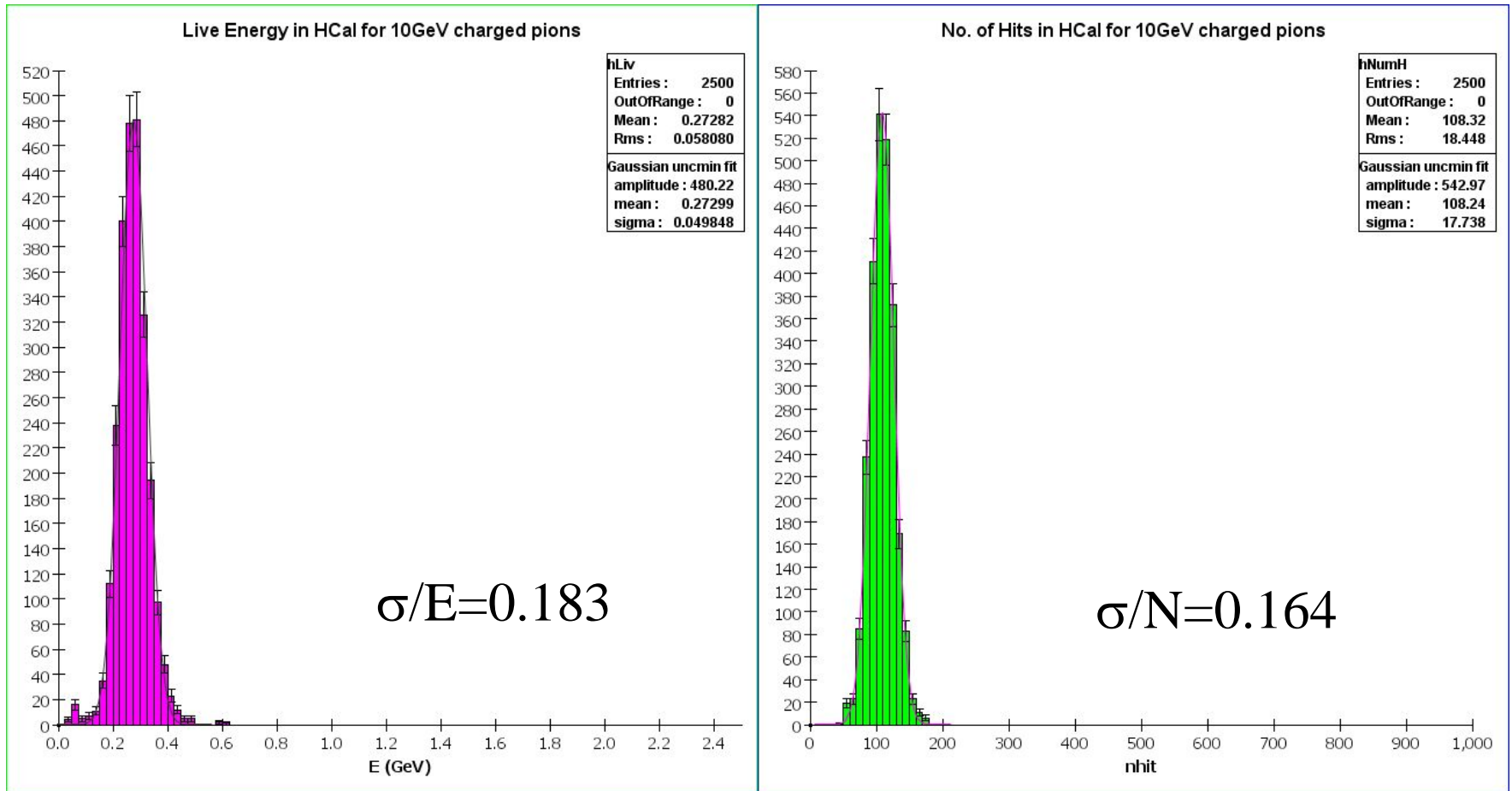

# $\pi^+$ energy resolution vs. energy

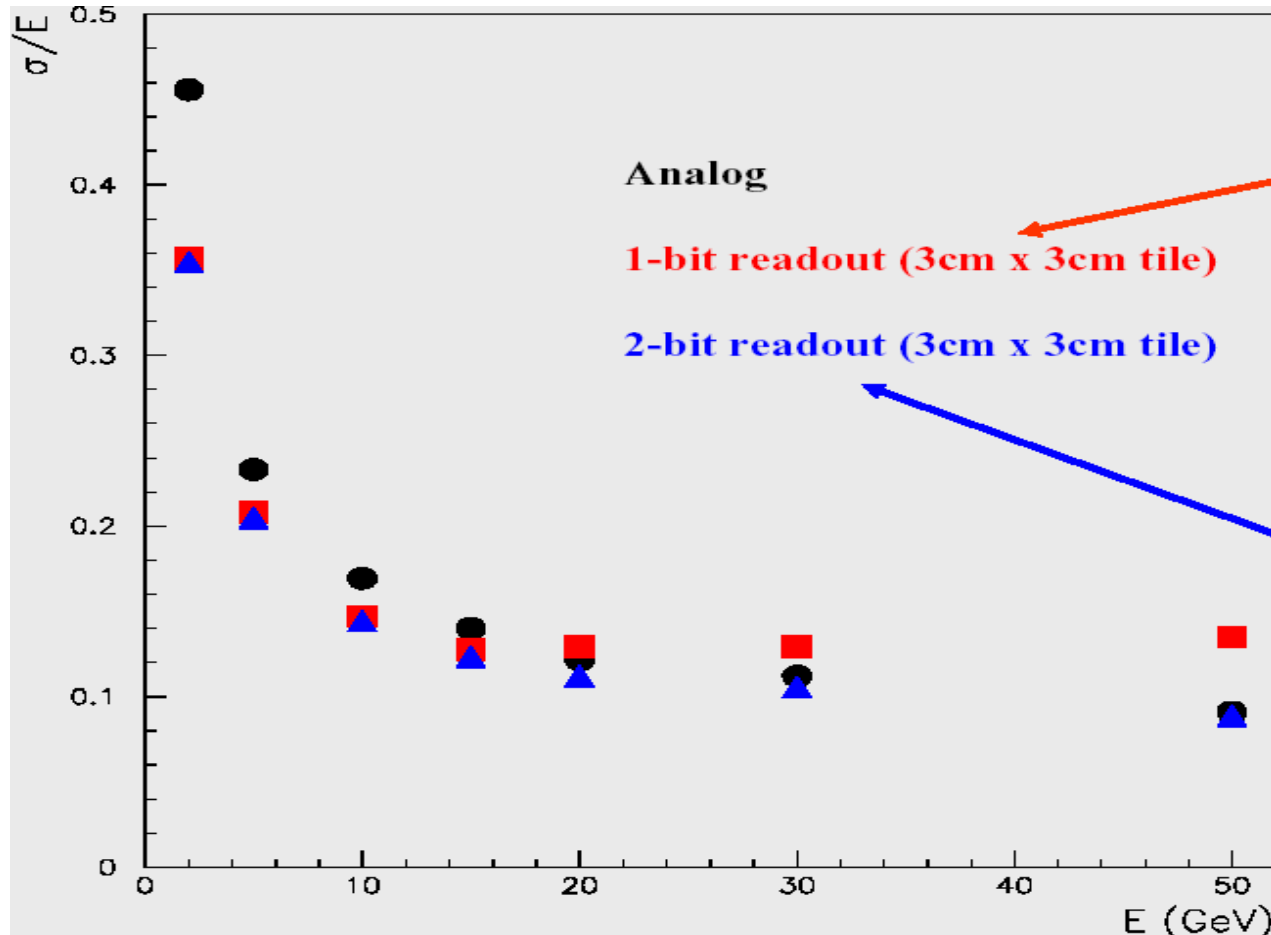

# Time of flight

Scintillator

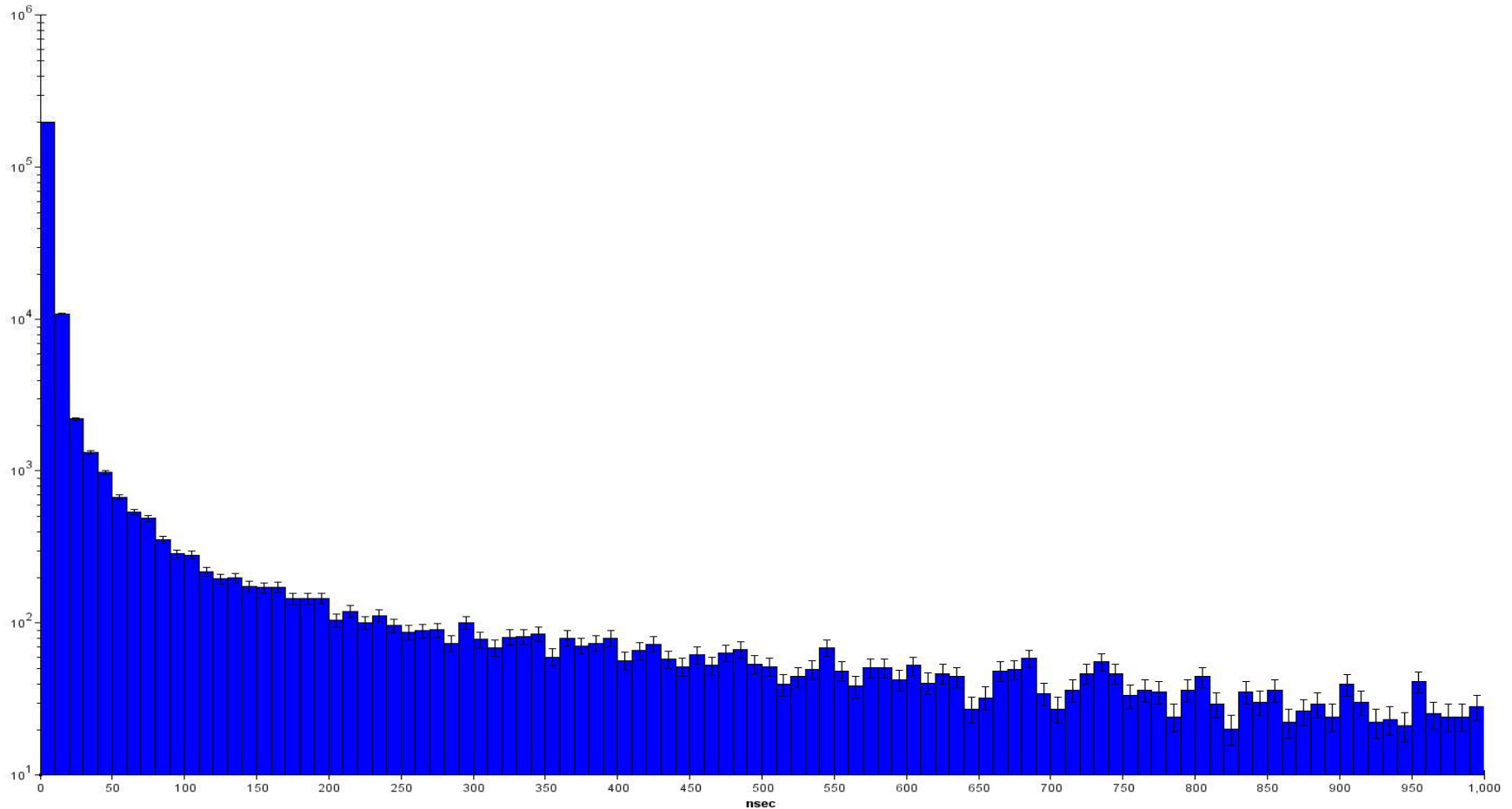

# ToF dependence

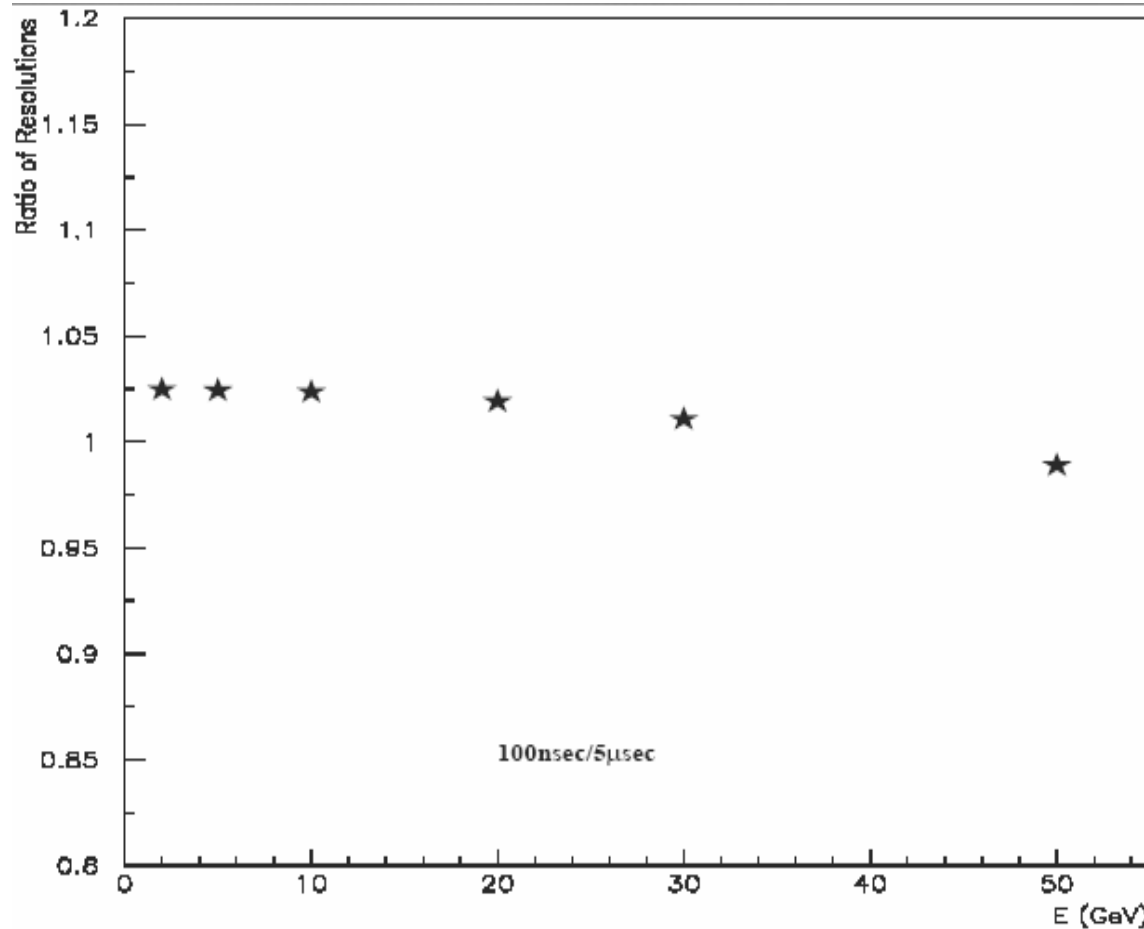

# Cross-talk

(10% of cell E leaks equally to 4 neighbors)

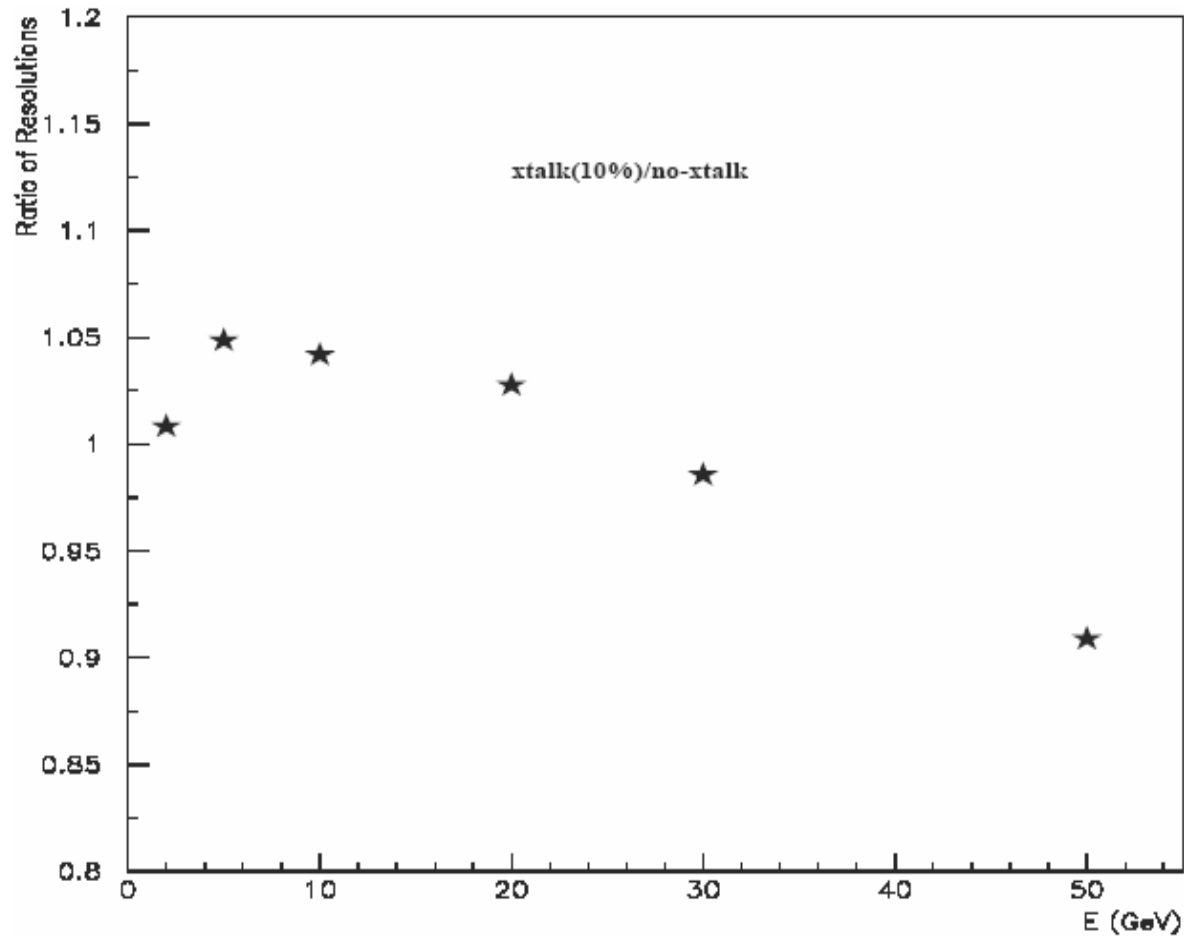

# Nhit vs. fraction of $\pi^+$ E in cells with $E > 10$ MIP: 1 cm x 1 cm scintillator cells

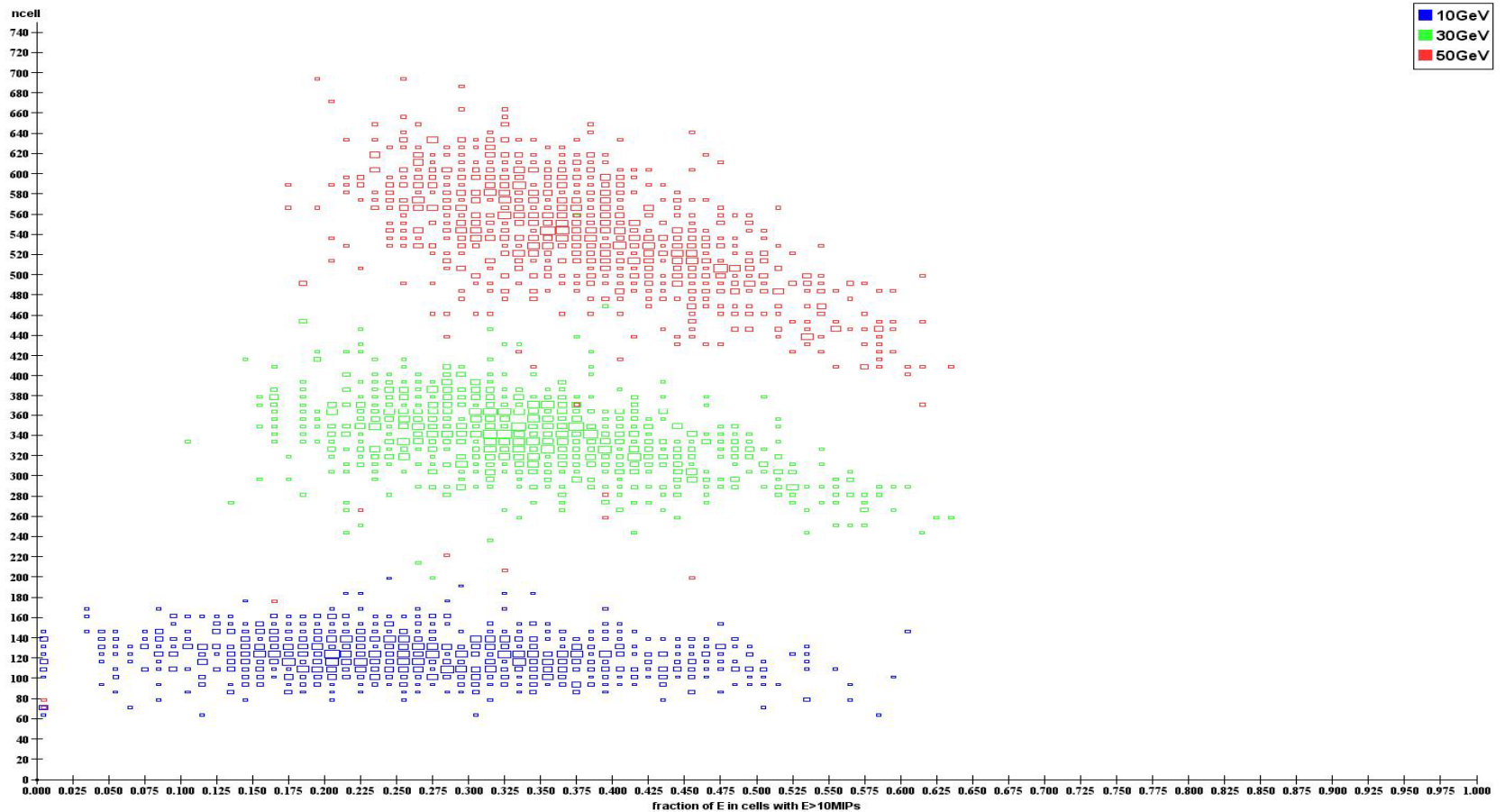



# Nhit vs. fraction of $\pi^+$ E in cells with $E > 10$ MIP: Gas vs. scintillator

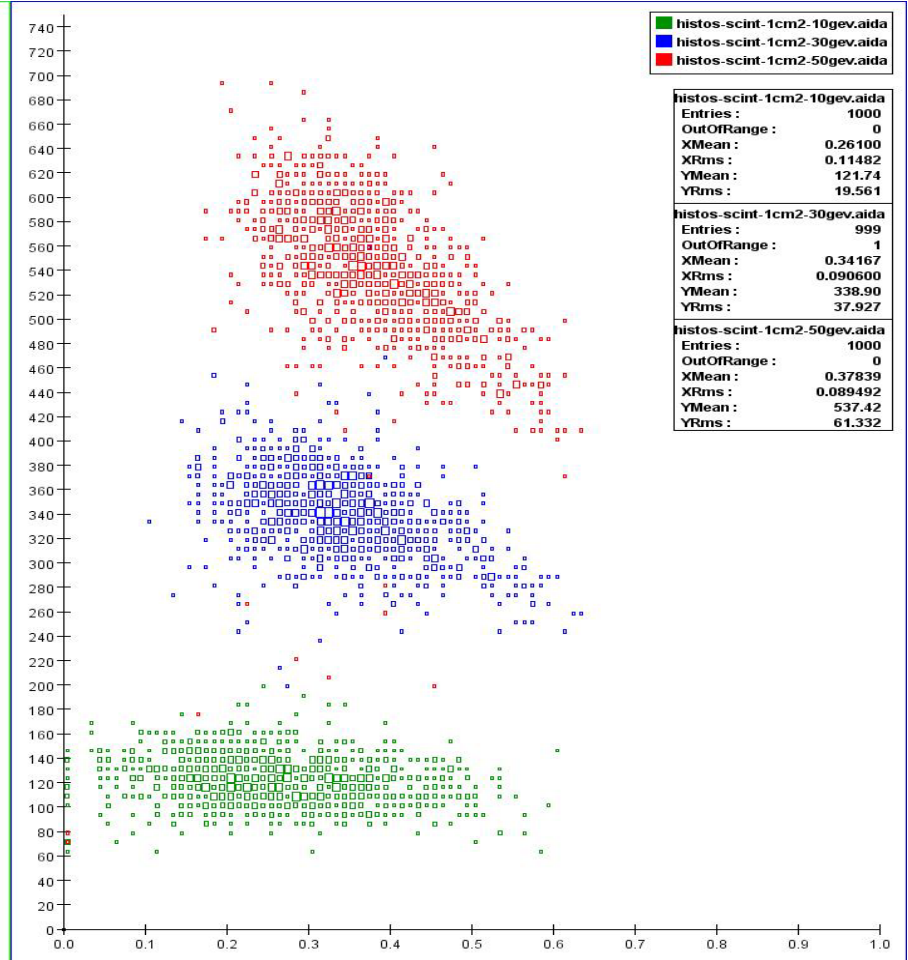
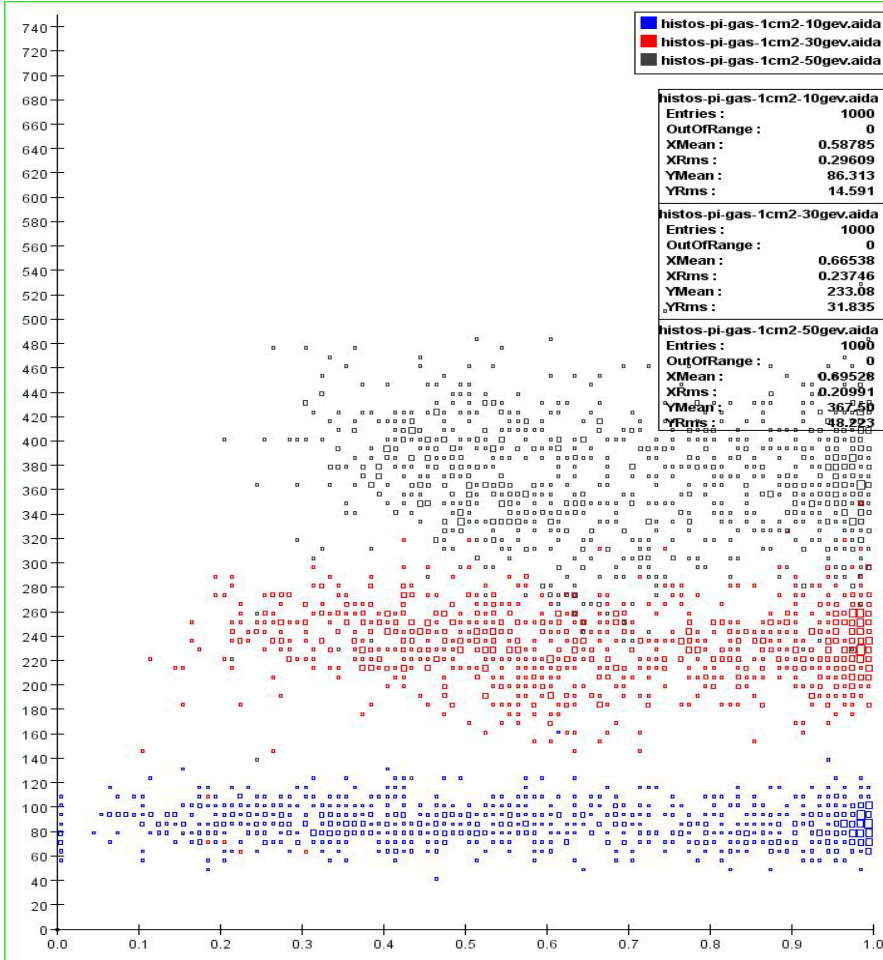

# $\pi^+$ energy resolution vs. energy

Multiple thresholds not used

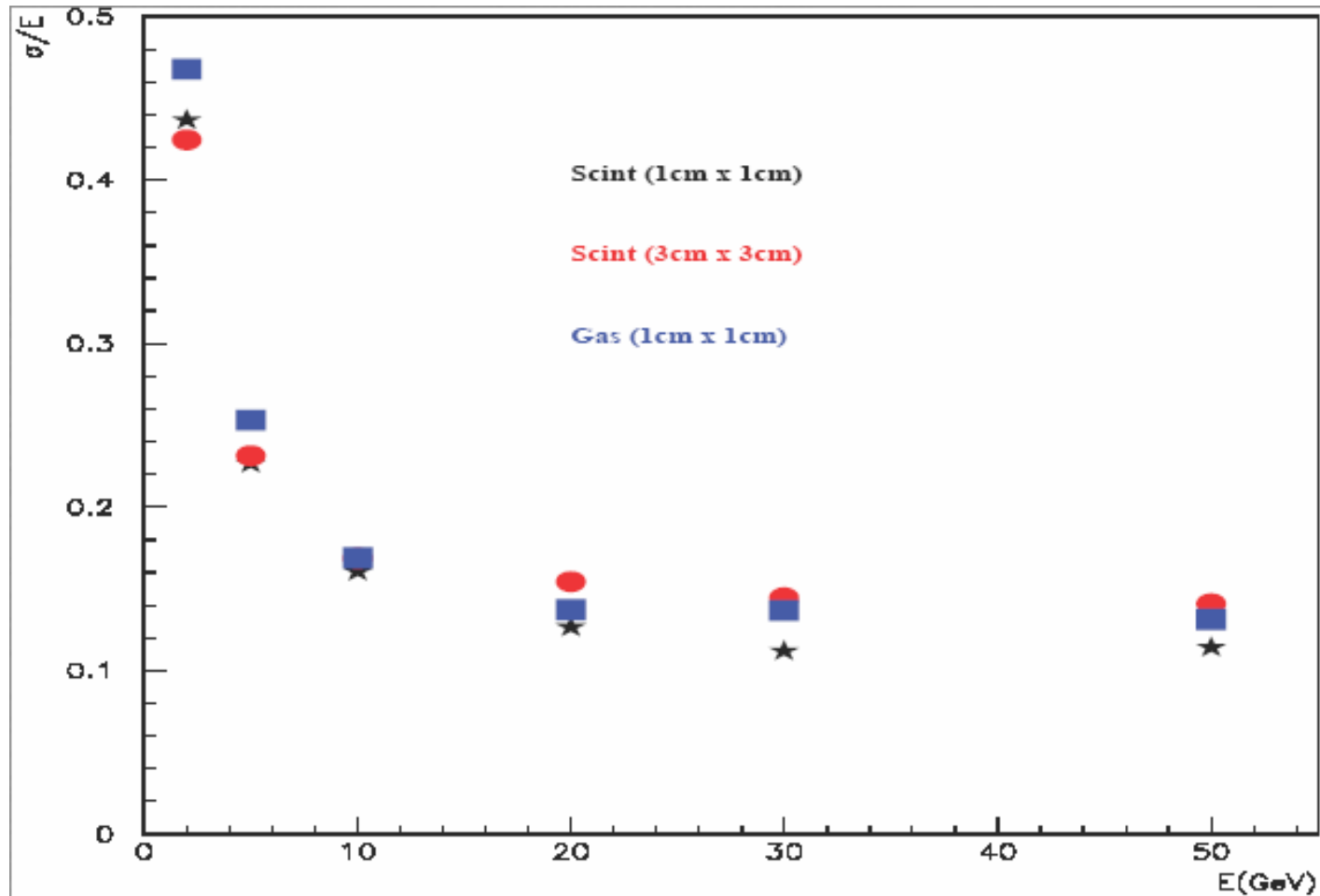

# Non-linearity

- $N_{hit}/\text{GeV}$  varies with energy.
- This will introduce additional pressure on the “constant” term.
- For scintillator, the non-linearity can be effectively removed by “semi-digital” treatment.

# Density of hits

- Need a hierarchy in the absence of an energy measurement.
- Local density of hits is an obvious candidate.
- A simple-minded density variable:

$$d_i = \sum (1/R_{ij}),$$

where  $R_{ij}$  is the angular distance between cells  $i$  &  $j$ .

# Position resolution

Measured relative to the energy weighted resolutions

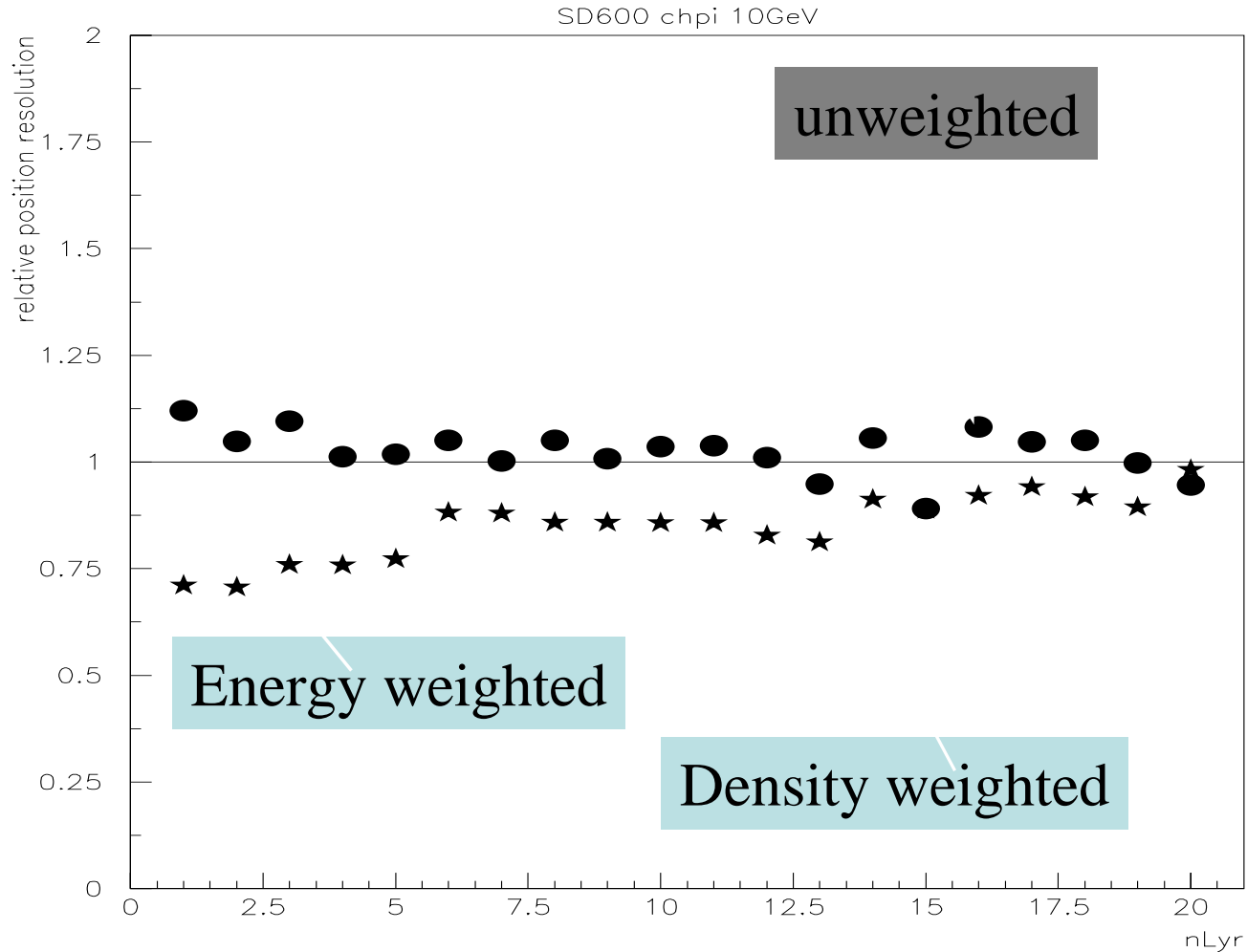

# Density vs. Energy

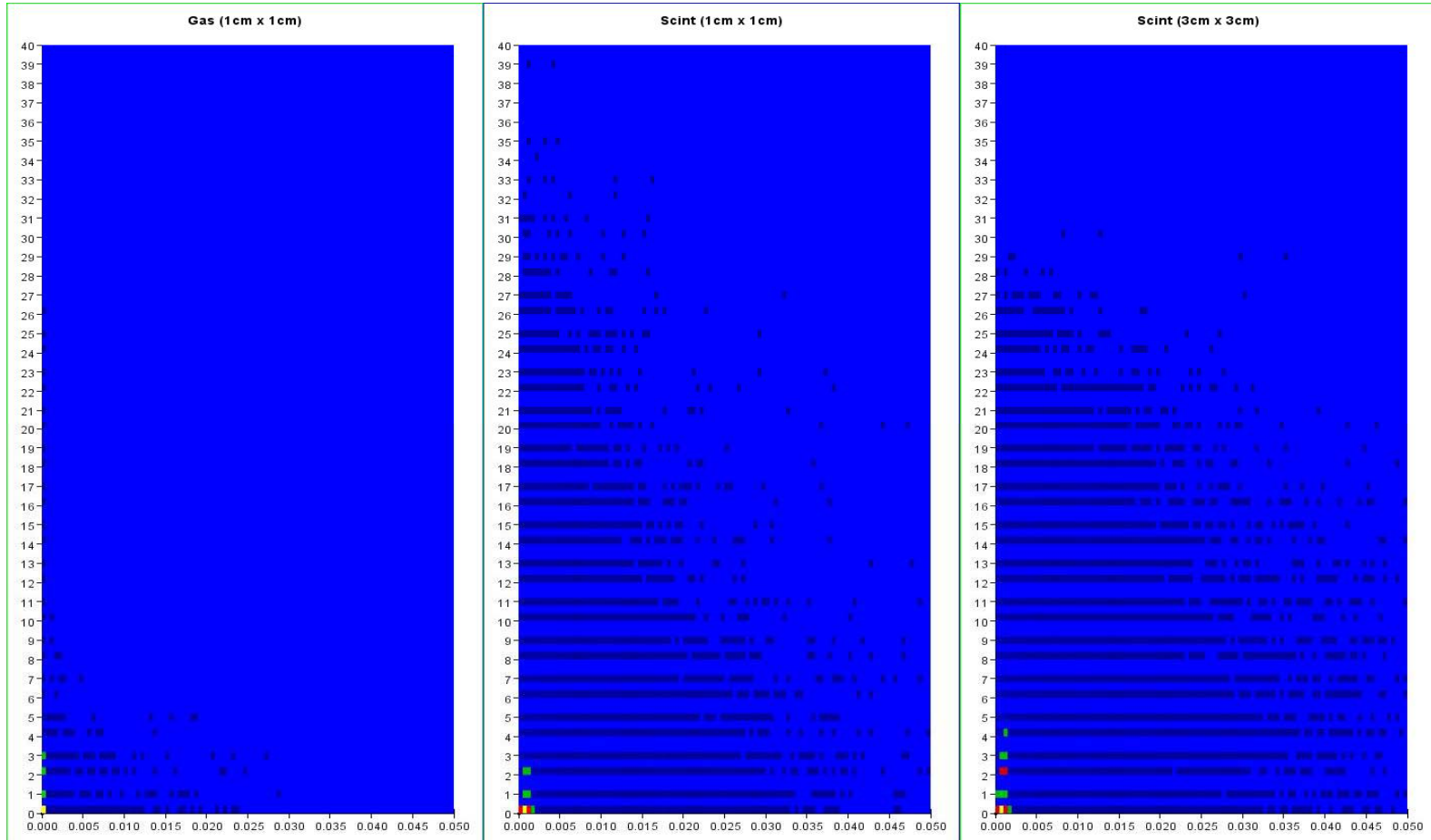

# Shower Width

- Find centroid  $\{Sw_i x_i / Sw_i\}$
- ‘width’ =  $\text{sqrt}(Sw_i R^2_i / Sw_i)$
- Three weights were used:
  - Unweighted ( $w_i=1$ )
  - Energy weighted ( $w_i=E_i$ )
  - Density weighted ( $w_i=\text{nearest-neighbor occupancy in a } 5 \times 5 \text{ window in lyrs } k-1, k, k+1$ )

# Distance to farthest cell

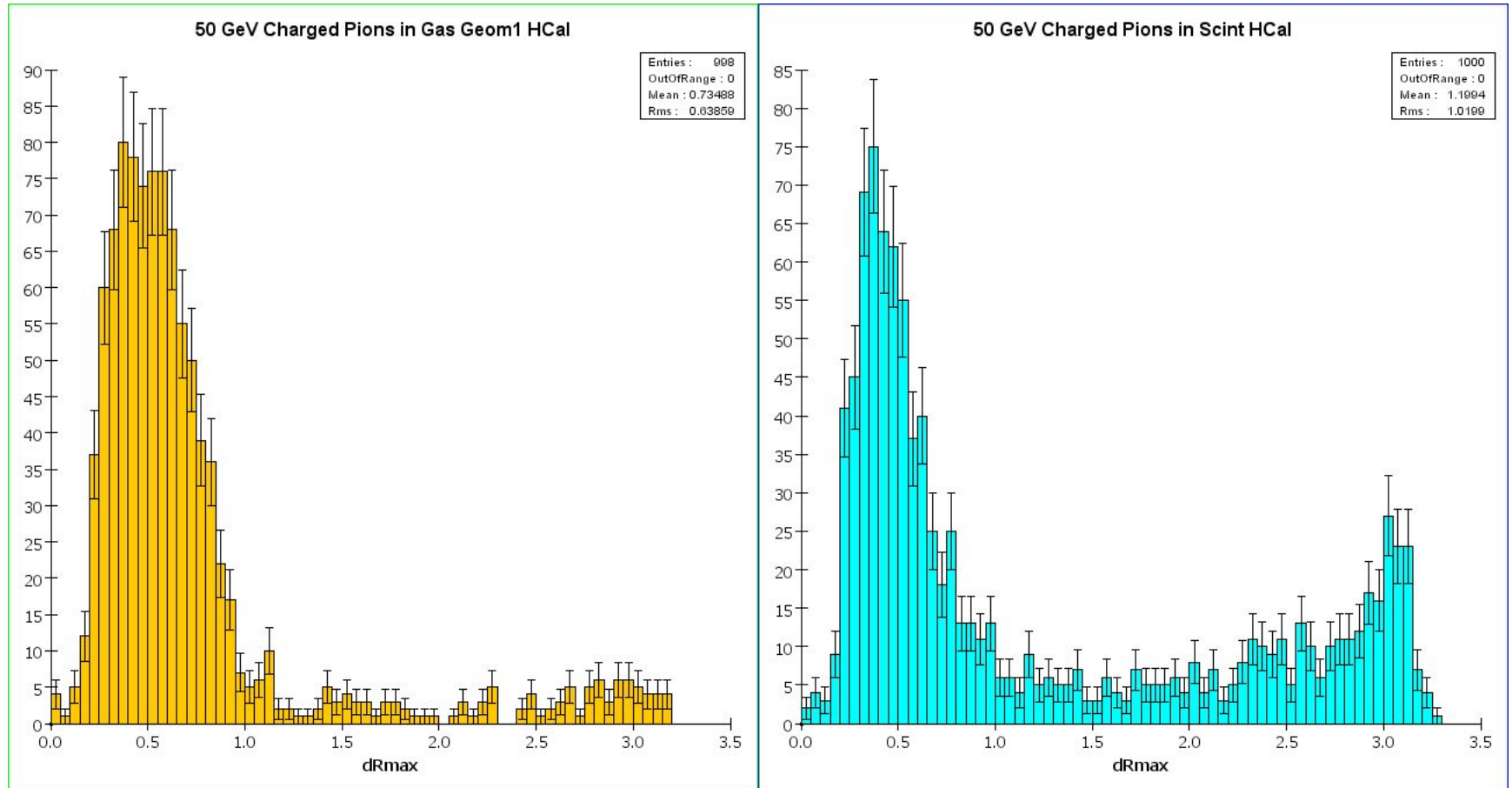



# Density of farthest cell

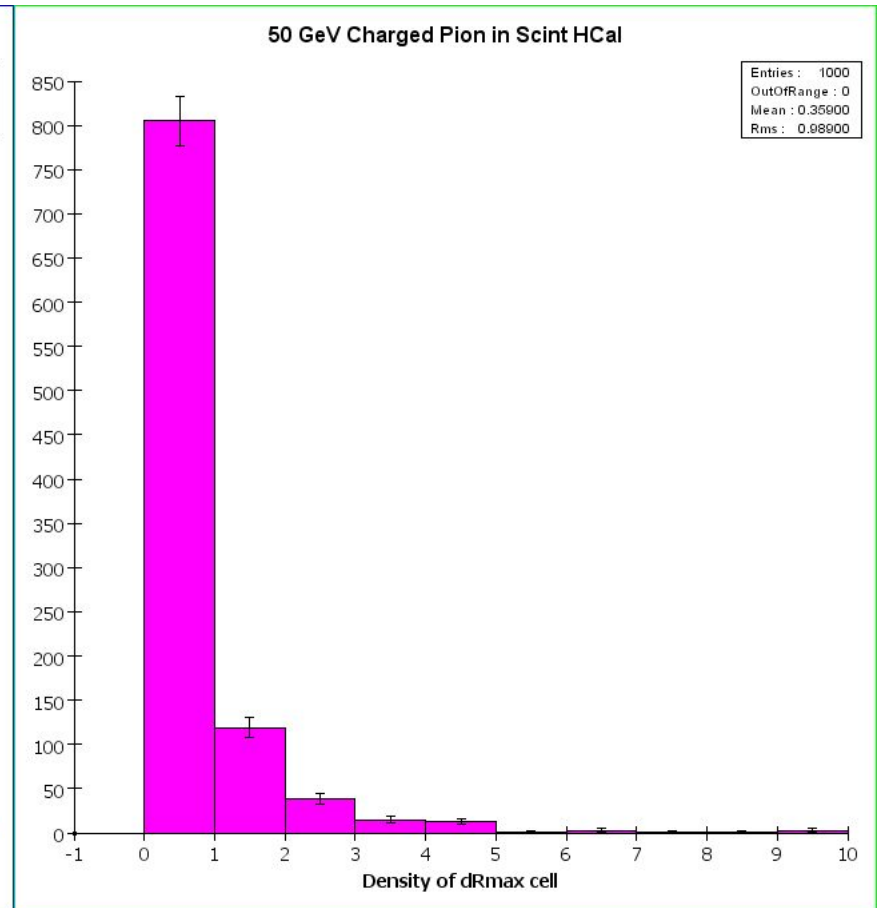
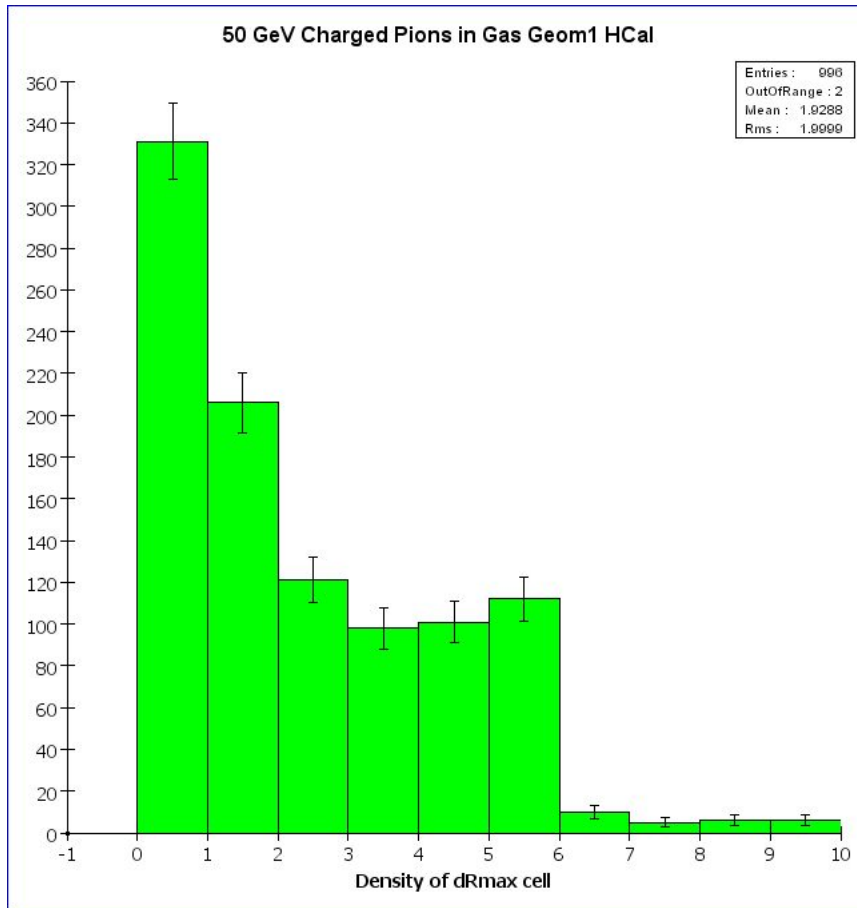

# Distance to farthest cell

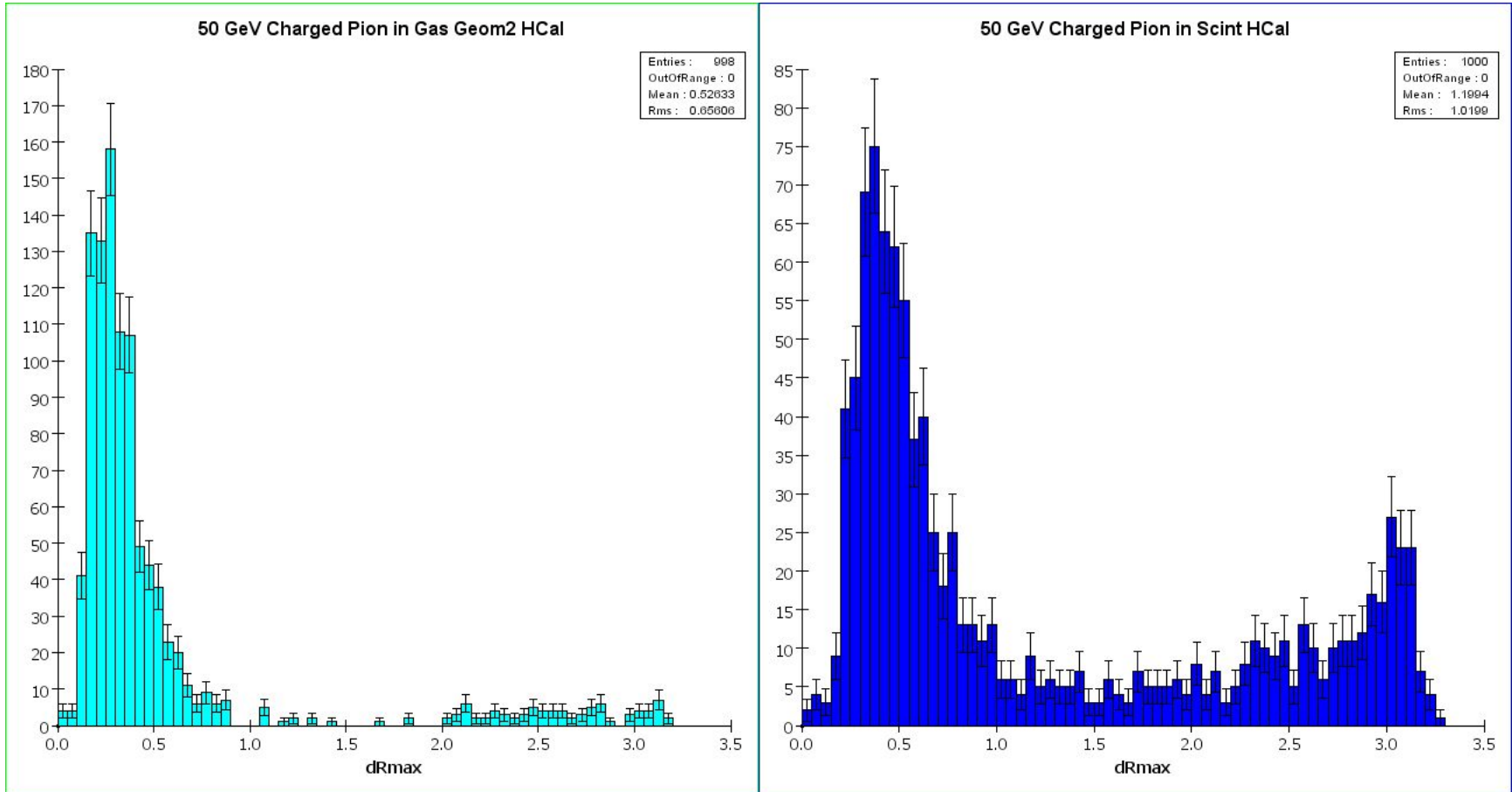

# Density of farthest cell

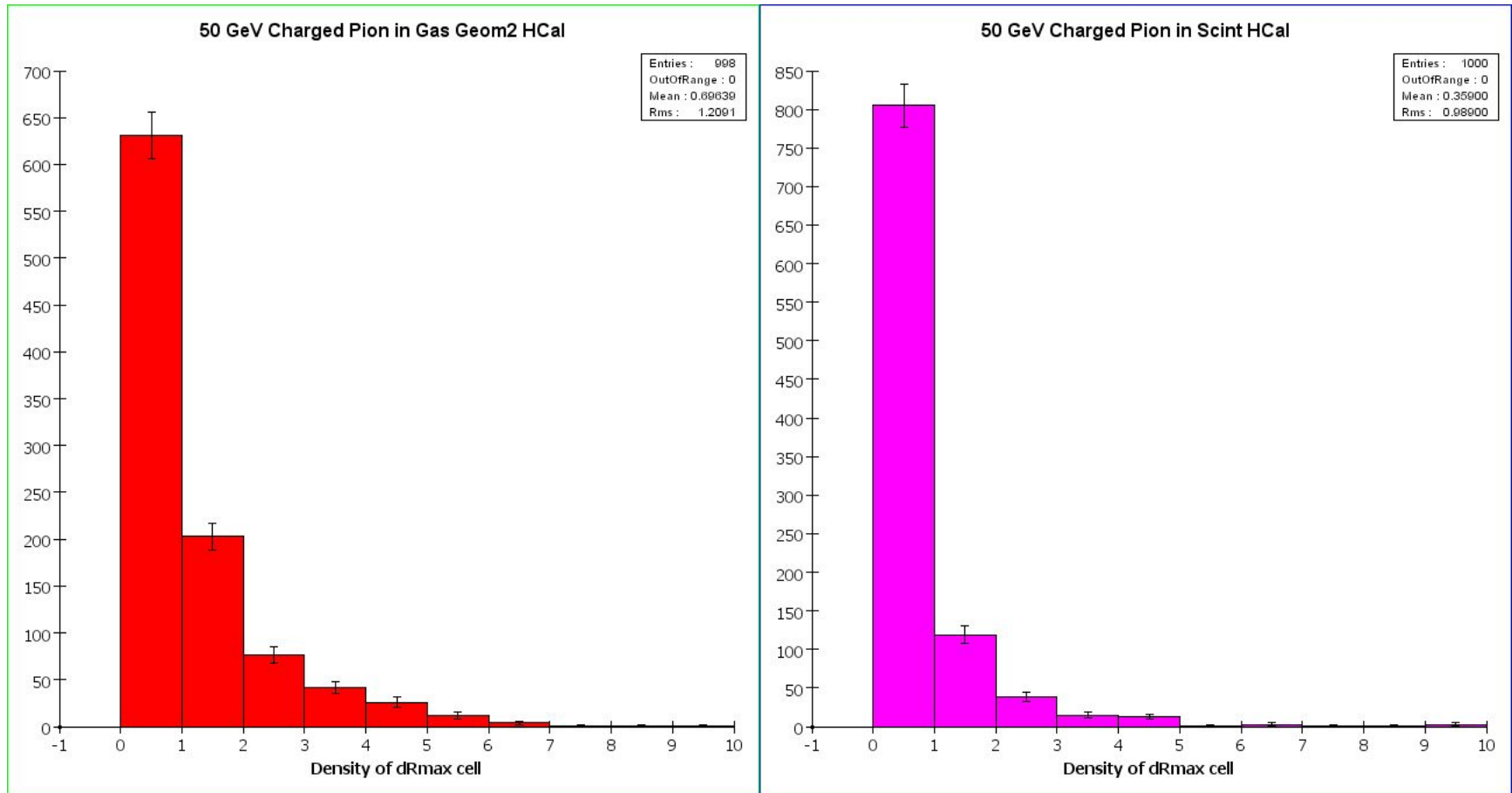

# Backscatter

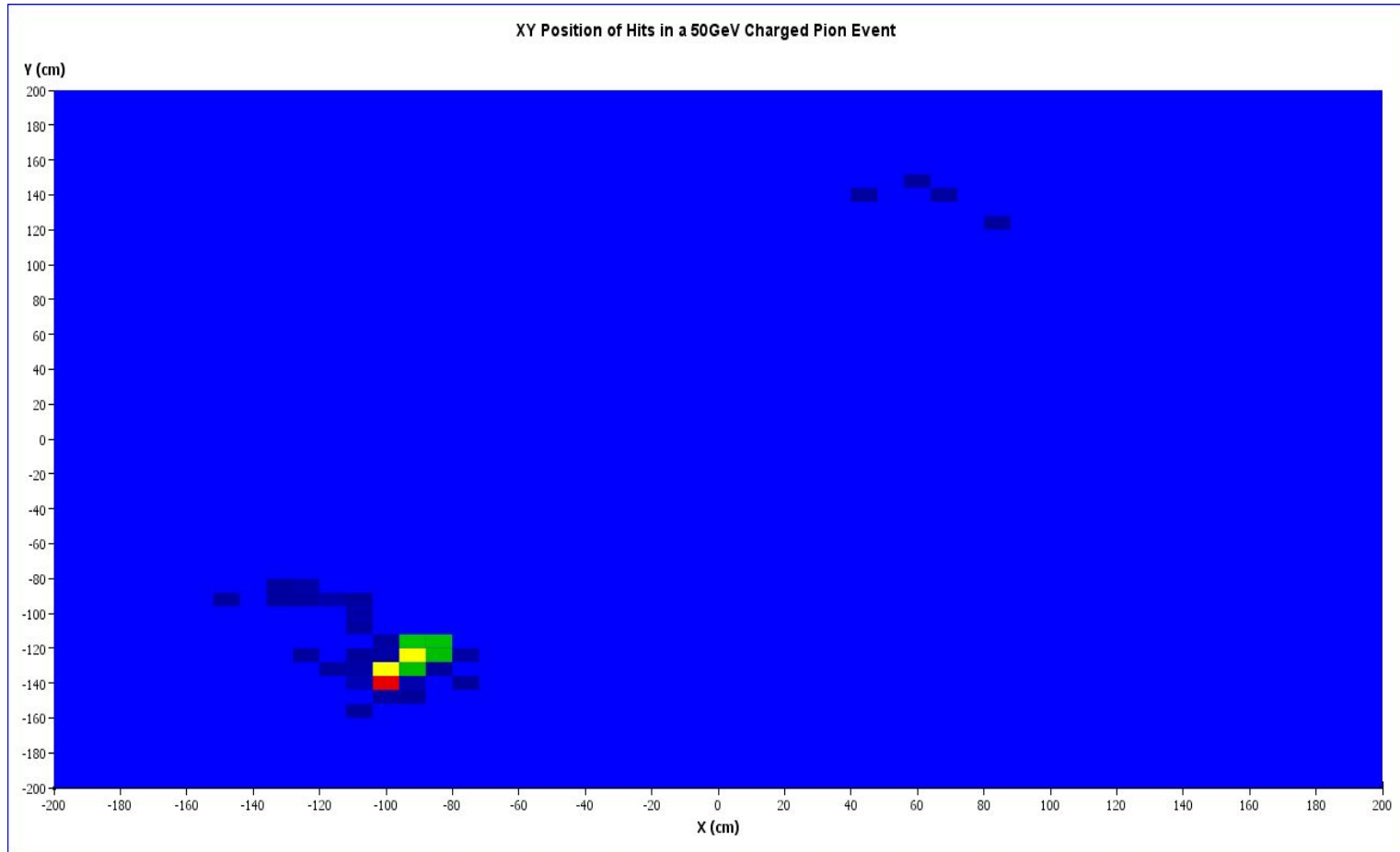

# Shower width for 10GeV $\pi^\pm$

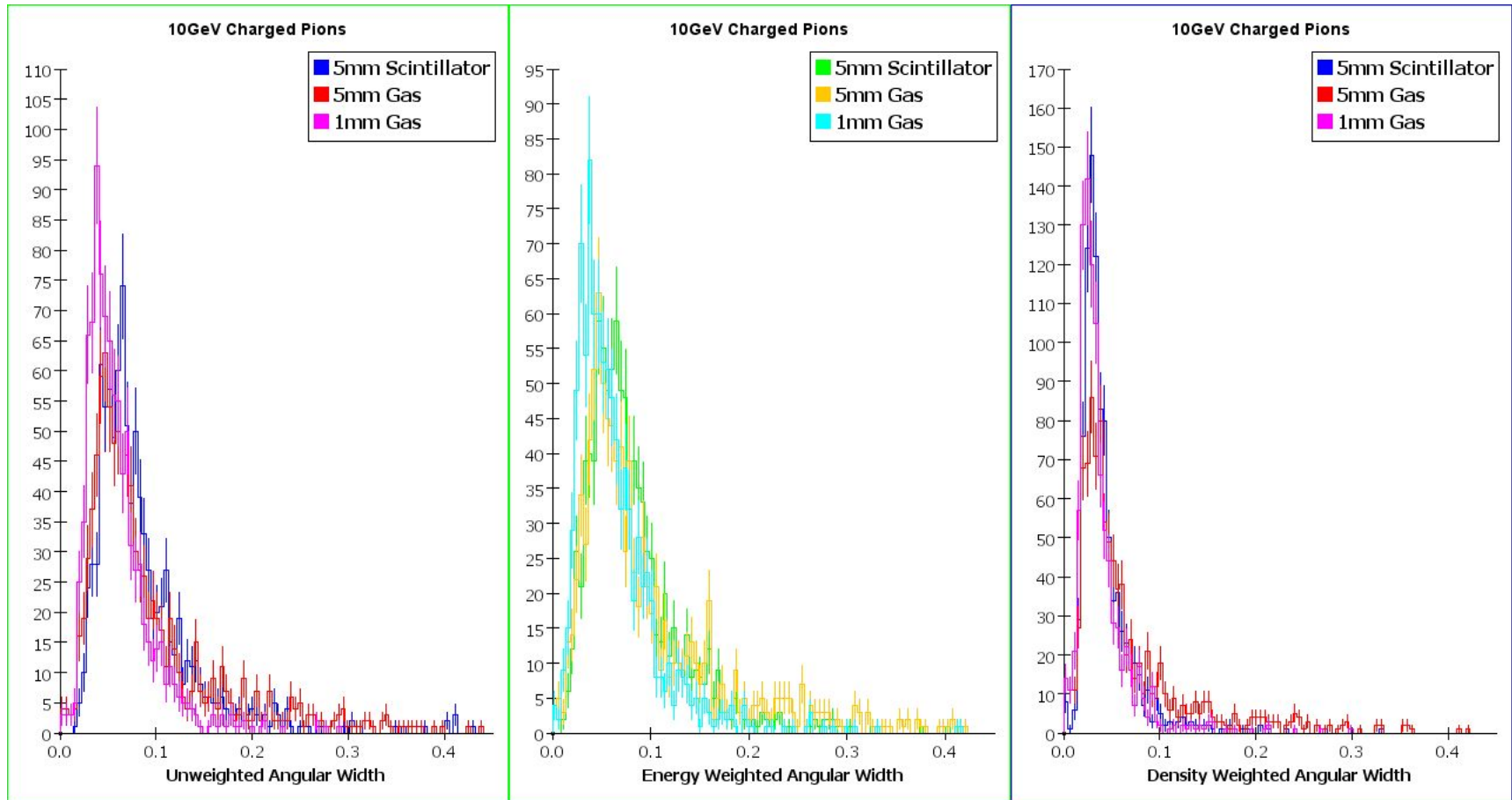

# Shower width for 50GeV $\pi^\pm$

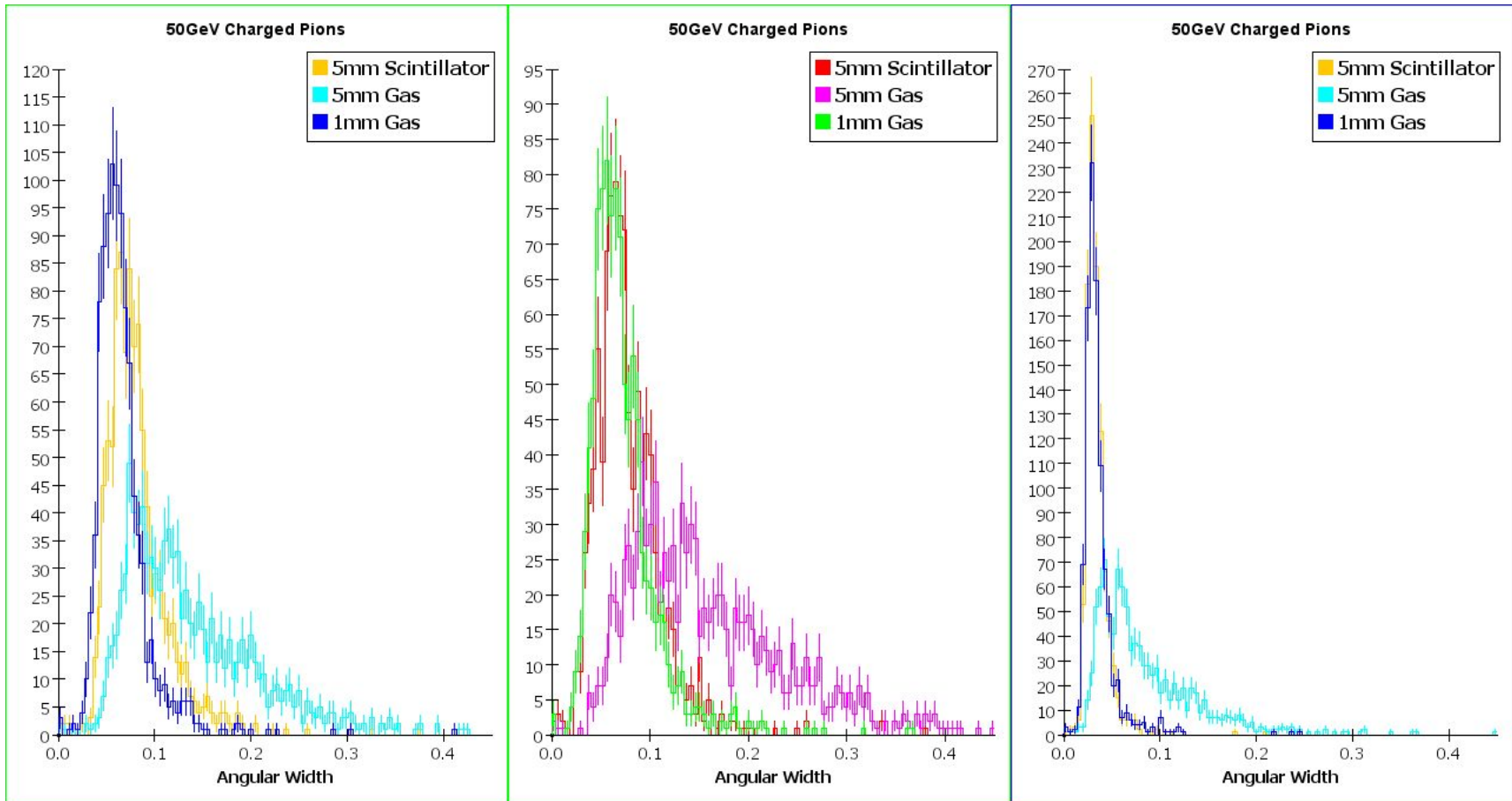

# $\pi^\pm$ angular width

rms shown as bars

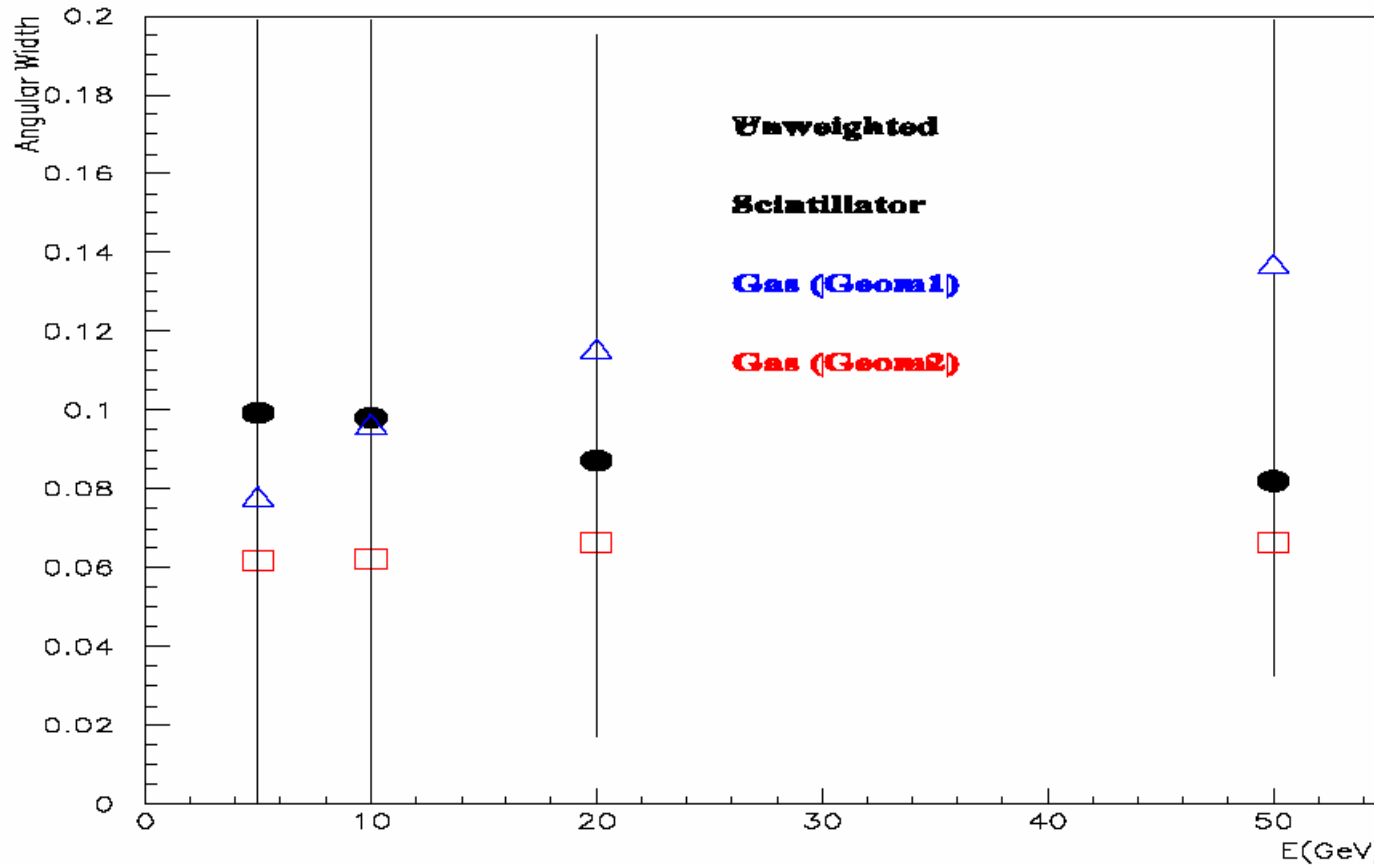

# $\pi^\pm$ angular width: energy weighted

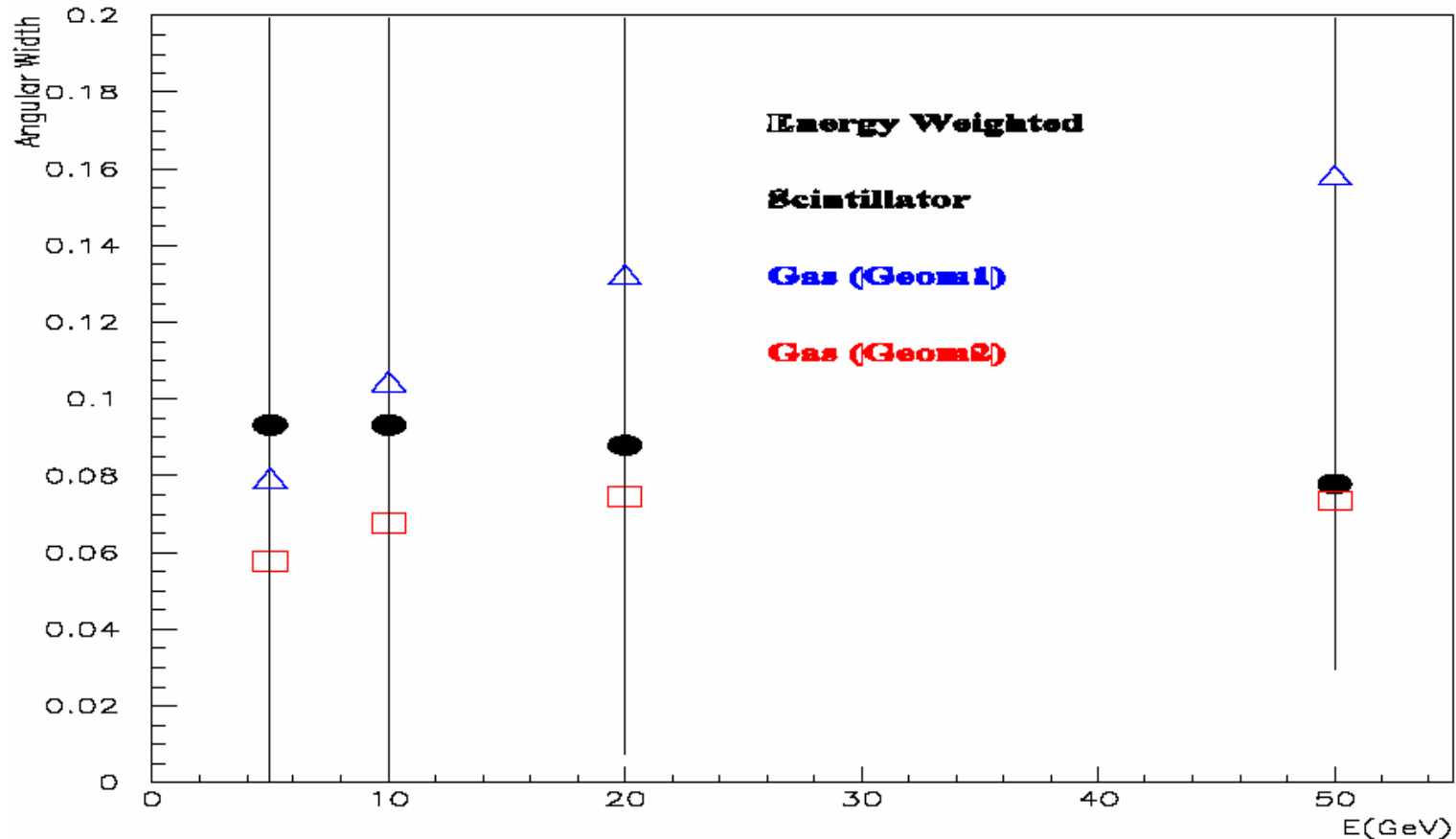



# $\pi^\pm$ angular width: density weighted

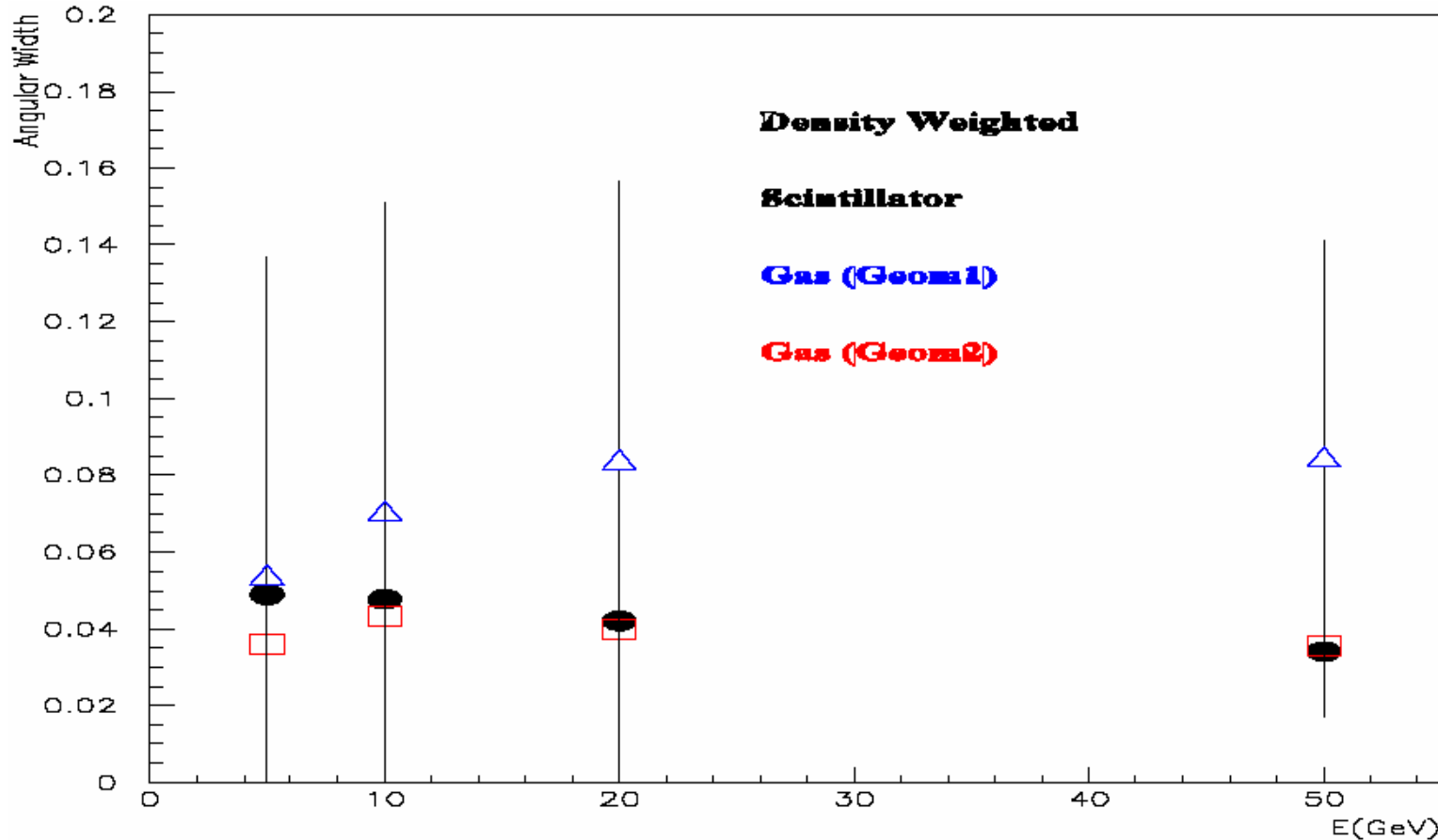

# Comments

- There is no clear cut case either way at the moment; detailed studies of assessing impact needed.
- Will look at cluster separability next.
- Need to evaluate this in the global context of calorimeter performance.

# Clustering

- Clustering based on local density works well.
- It is an alternative to track-seeded clustering.
- Can be used in the ECal and HCal.
- Full PFA implementation (not shown) gives encouraging results.

# 10 GeV $\pi^0 \rightarrow \gamma\gamma$

Density weighted  $\theta-\phi$

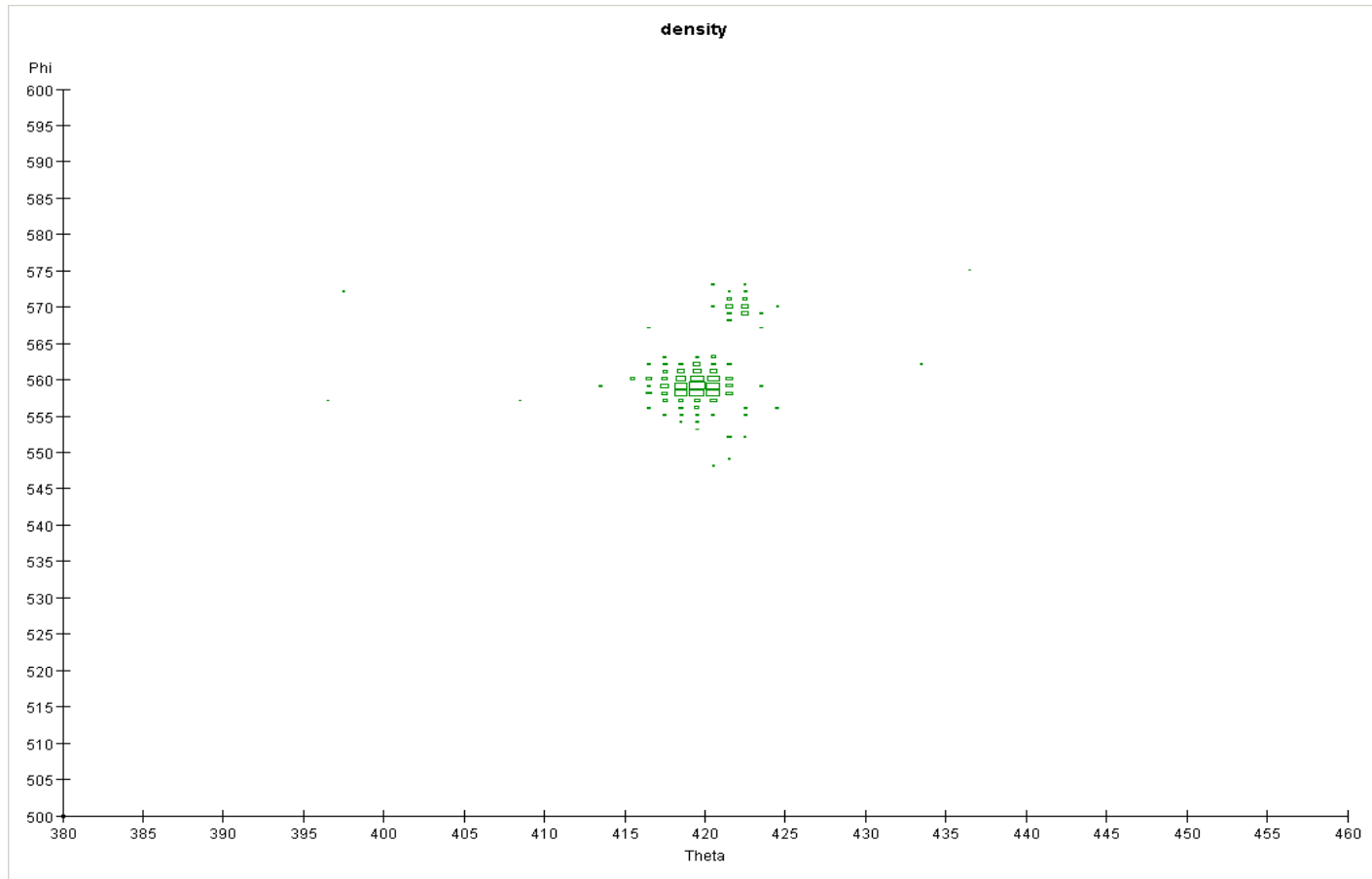



Density weighted  $\theta-\phi$

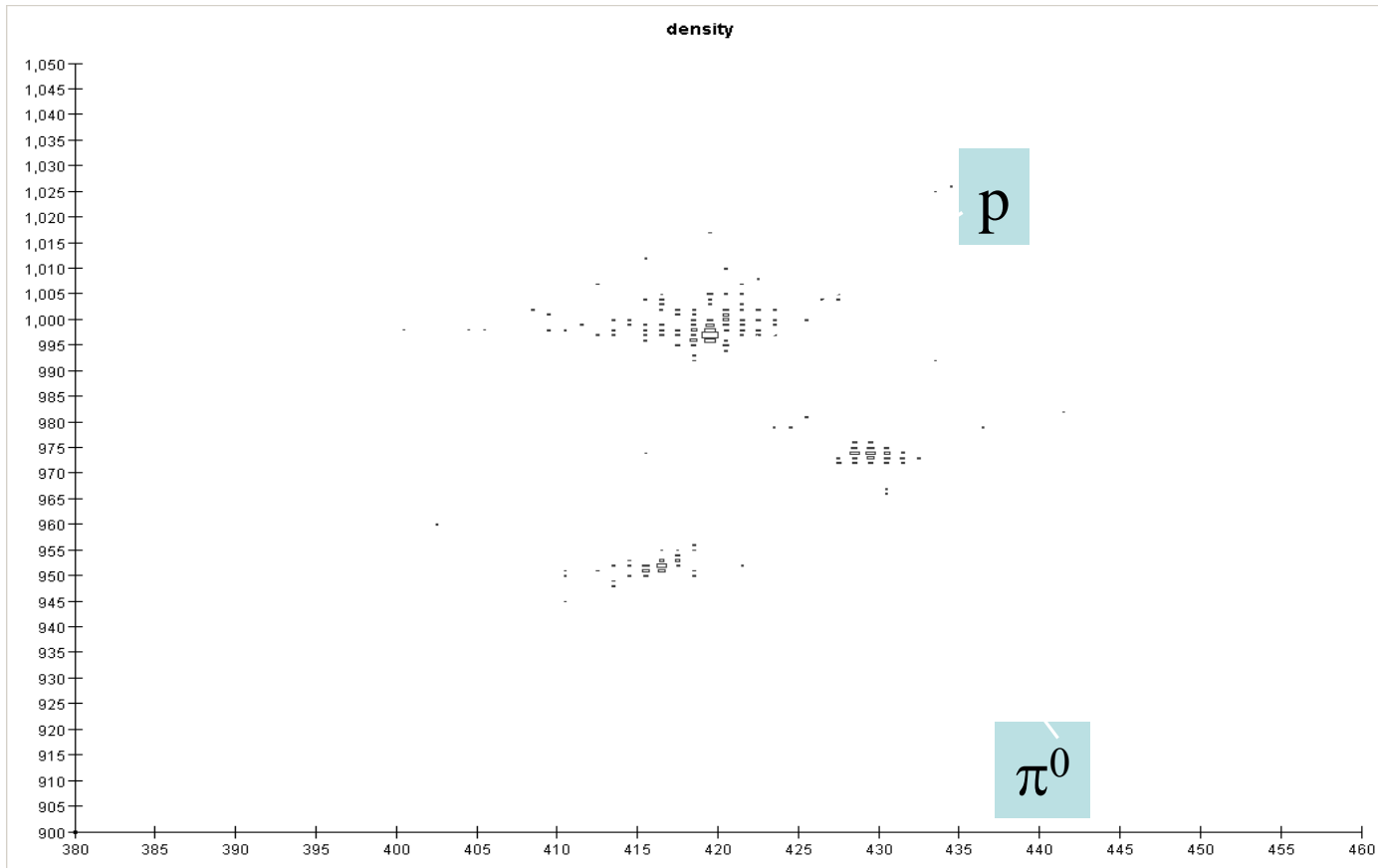

# Simulation Summary

- Large parameter space in the nbit-segmentation-medium plane for hadron calorimetry. Optimization through cost-benefit analysis?
- Scintillator and Gas-based ‘digital’ HCalS behave differently.
- Need to simulate detector effects (noise, x-talk, non-linearities, etc.)
- Need verification in test-beam data.
- More studies underway.

# Beam Test: Goals

- 1 m<sup>3</sup> Hadron beam prototype
- Test the analog and semi-digital scintillator-based HCAL concept
- High granularity core with 3cm tiles
- 8000 channels in total

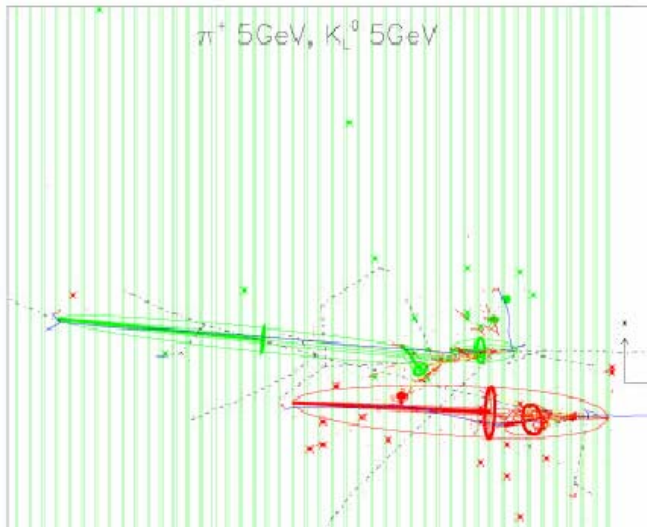

A.Raspereza (DESY)

Two showers :  $\pi^+$  10GeV,  $K_L^0$  10GeV

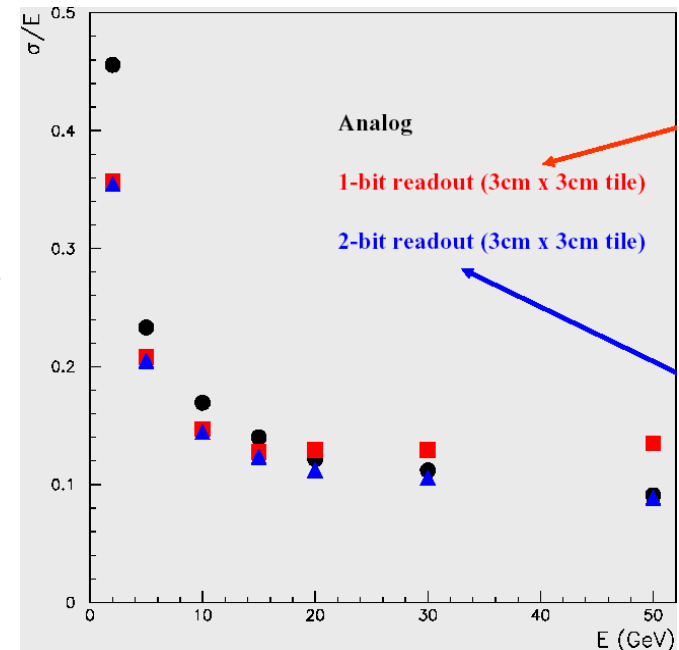
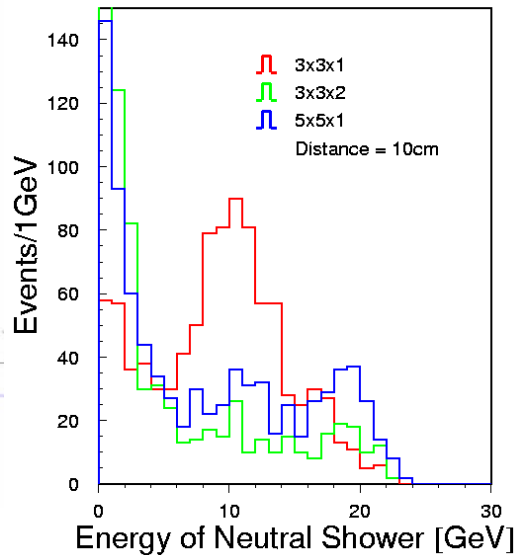

V.Zutshi (NIU)

Reading every layer is essential

# Beam Test: Goals

- Technology: Gain large scale, long-term experience with a SiPM readout detector
  - Identify critical operational aspects to optimize photo-detector, electronics and calibration system
- Physics: Collect data samples ( $\sim 10^8$  evts) to
  - Study hadron showers with unprecedented granularity
  - Validate hadronic shower models
  - Develop PFAs

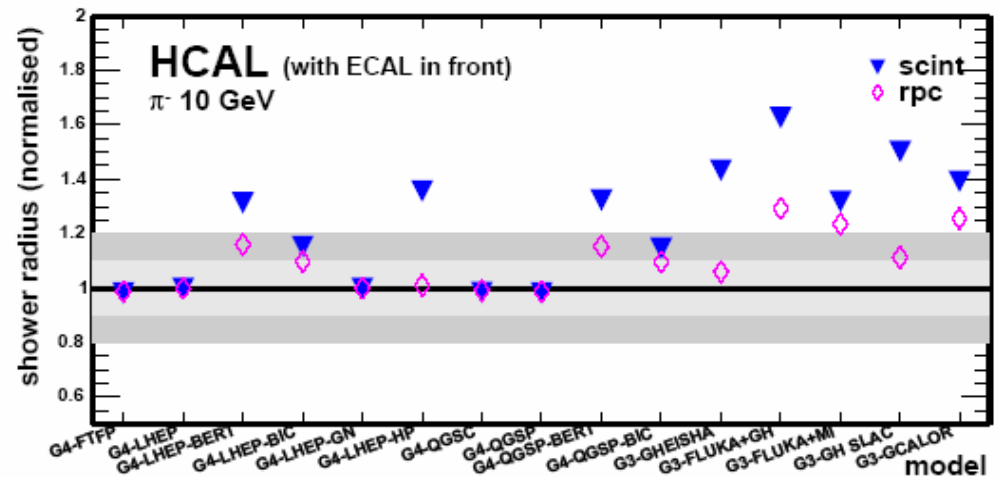



# TB: Design Challenges

- Design based on minimal experience (SiPM, scintillator, cable) – but...
- Industrialize SiPM and tile production – scale by 2 orders of magnitude
- 8k channel bias supply and readout electronics for beam test with ECAL
- Versatile calibration & monitoring system
- Modular mechanical design

NOT a prototype  
for an ILC detector

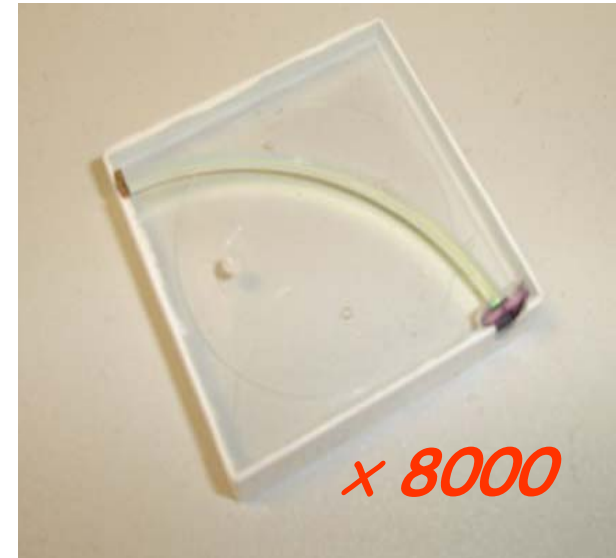

# CALICE Beam Test Preparations

## Collaborative effort

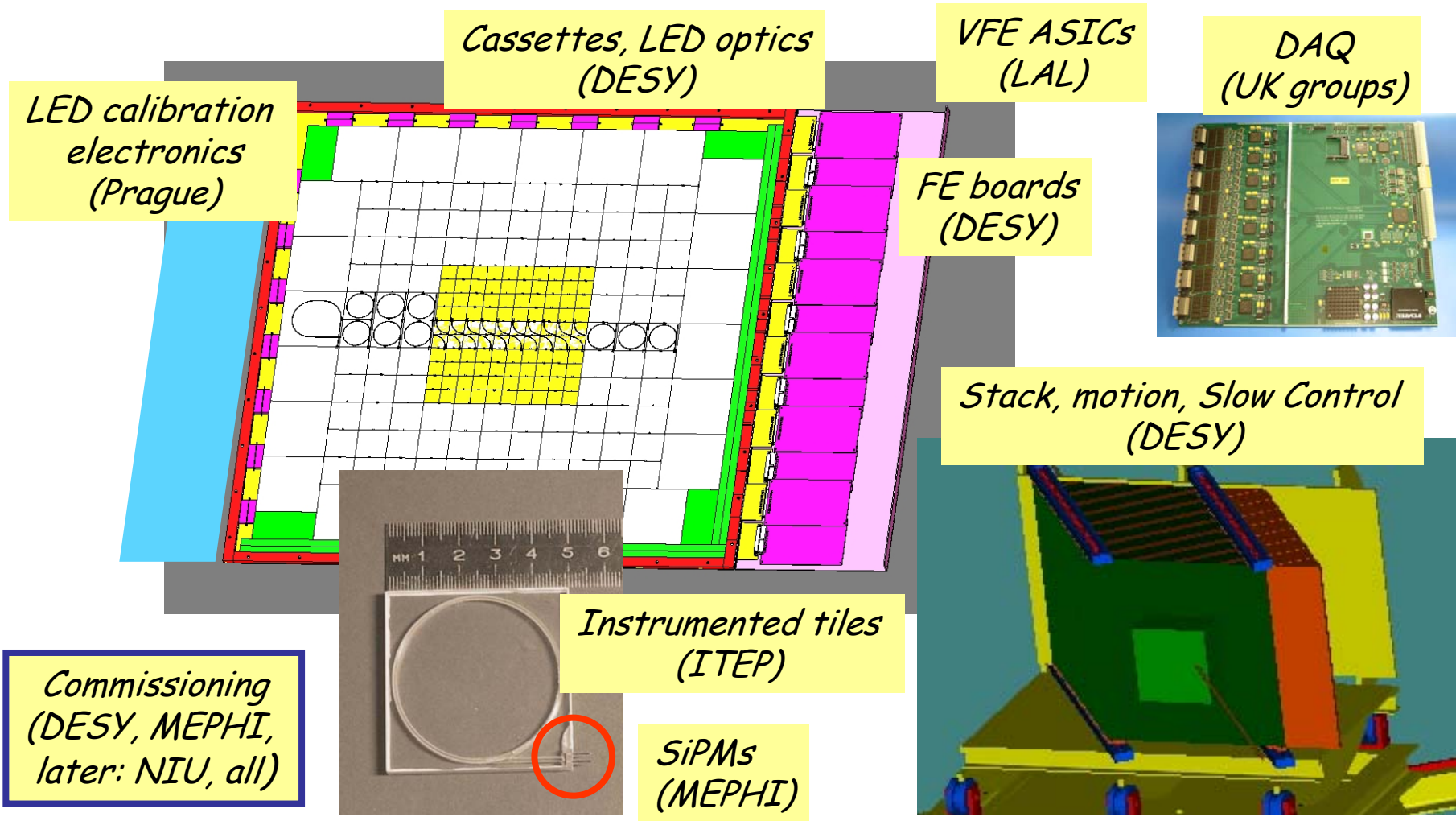

# CALICE Beam Test Preparations

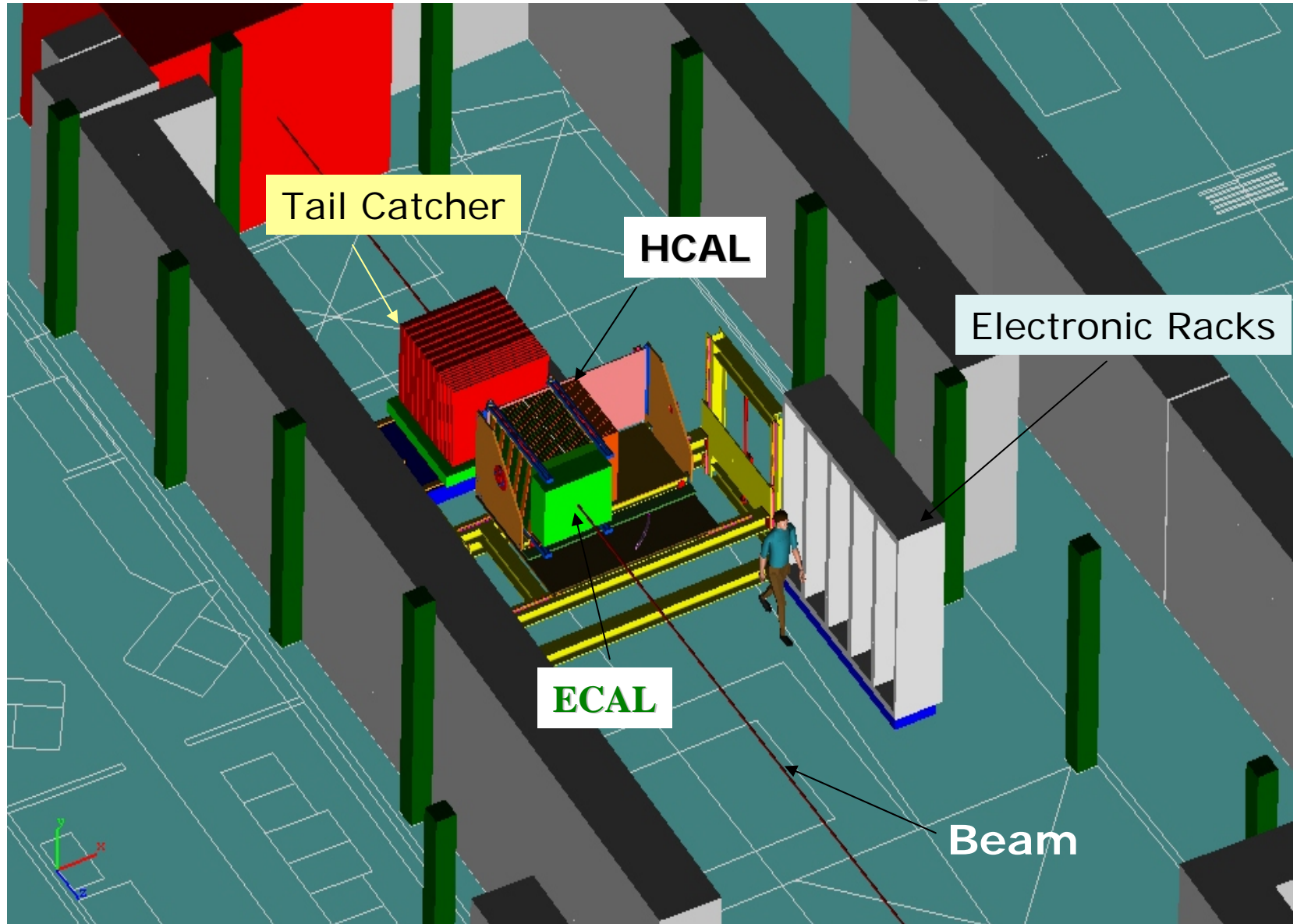

# TB: Scint HCal layer composition

- 10x10 array of  $(3 \text{ cm})^2$  cells surrounded by 3-wide frame of  $(6 \text{ cm})^2$  cells, then a 1-wide frame of  $(12 \text{ cm})^2$  cells.
- Scintillator production well advanced.
- Semi-automatic test bench for SiPM tile system ready
  - Measure light yield in px/MIP
- Ready for mass production of SiPM tile systems with data sheet

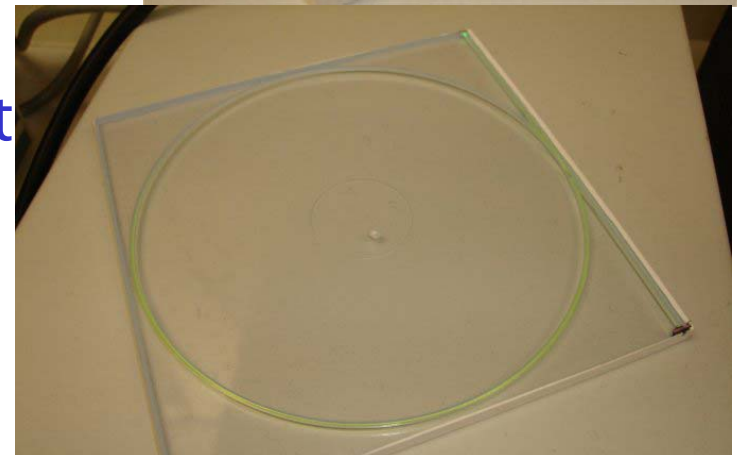
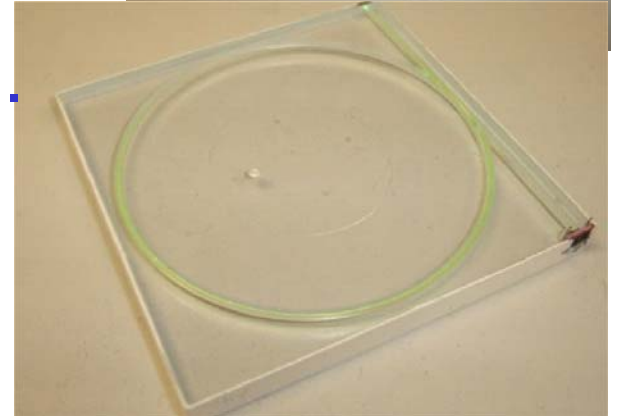

# TB: Scint HCal layer assembly

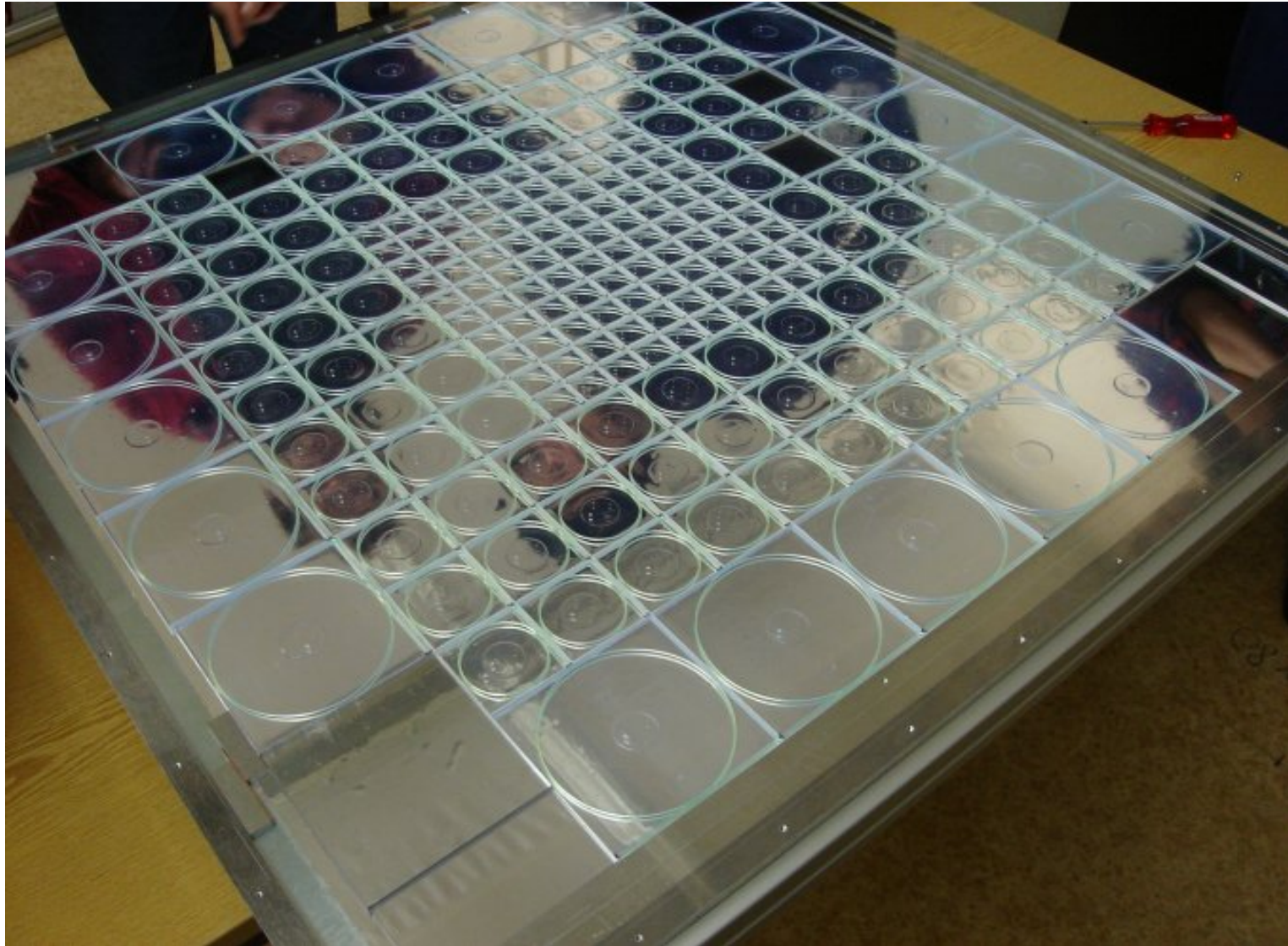

# TB: Tail-Catcher/Muon Tracker

- “Fine” section (8 layers): 2 cm thick steel
- “Coarse” section (8 layers): 10 cm thick steel
- 5mm thick, 5cm wide extruded scintillator strips
- 1.2 mm-diameter Kuraray Y11 fibers
- Tyvek/VM2000 wrapping
- Alternating x-y orientation
- Si-PM photo detection
- Common readout w/ Hcal
- Along beam: 142 cm
- Height: 109 cm
- Weight: ~10 ton

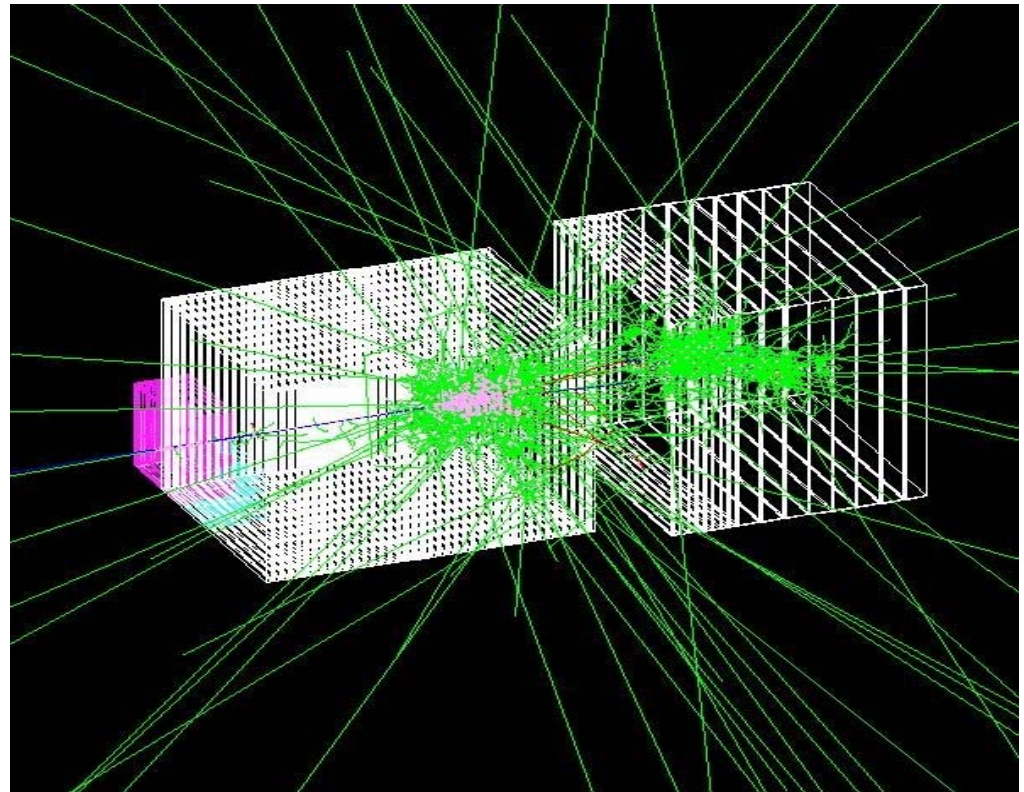

# TB: TCMT layer assembly



LC Study Group mtg,  
26-05-2005

Scintillator-based HCal for ILC  
Dhiman Chakraborty

# TB: TCMT layer assembly

WLSF-SiPM misalignment is within 0.1 mm

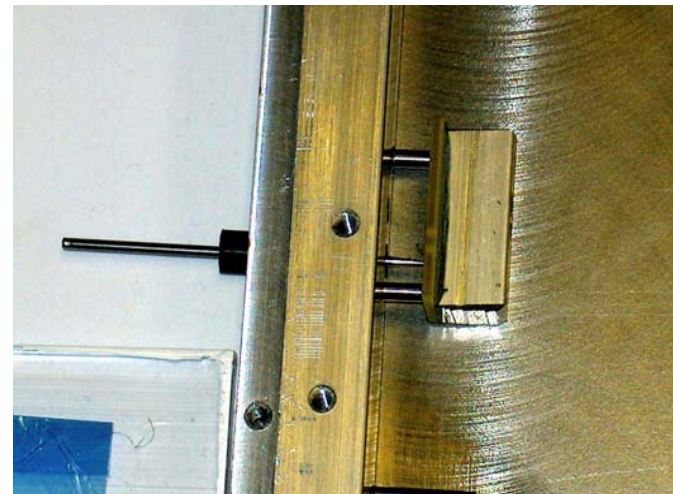
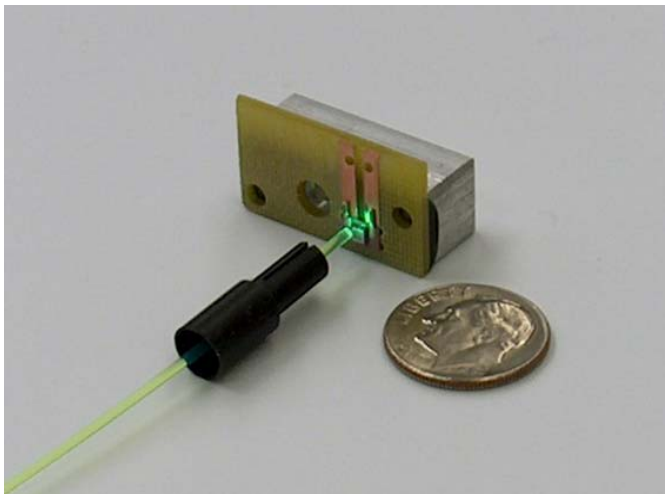
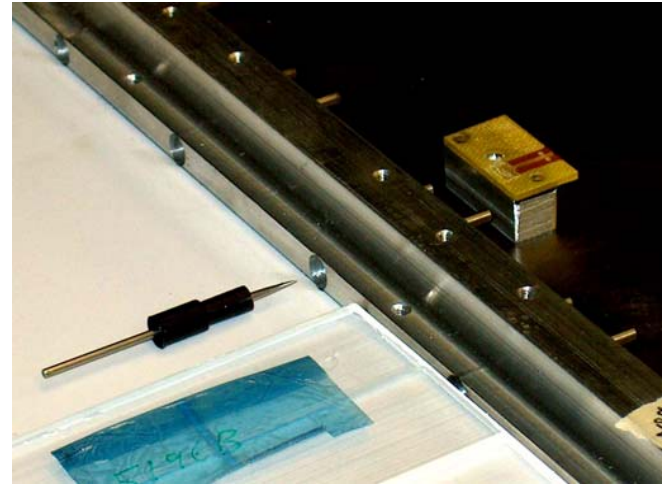
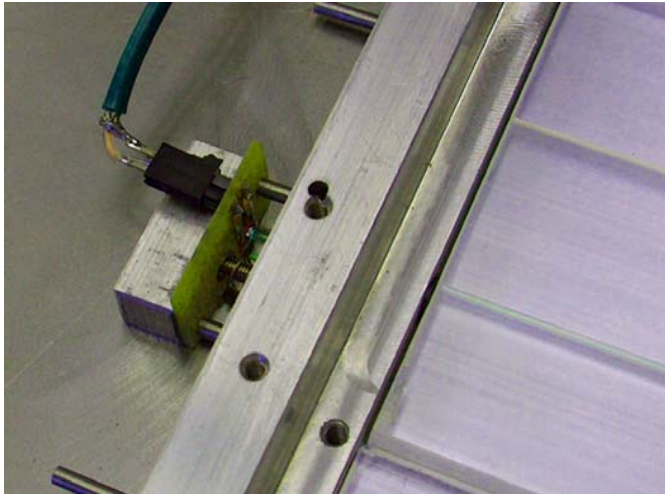



# TB: Front-end electronics

M. Reincke (DESY)

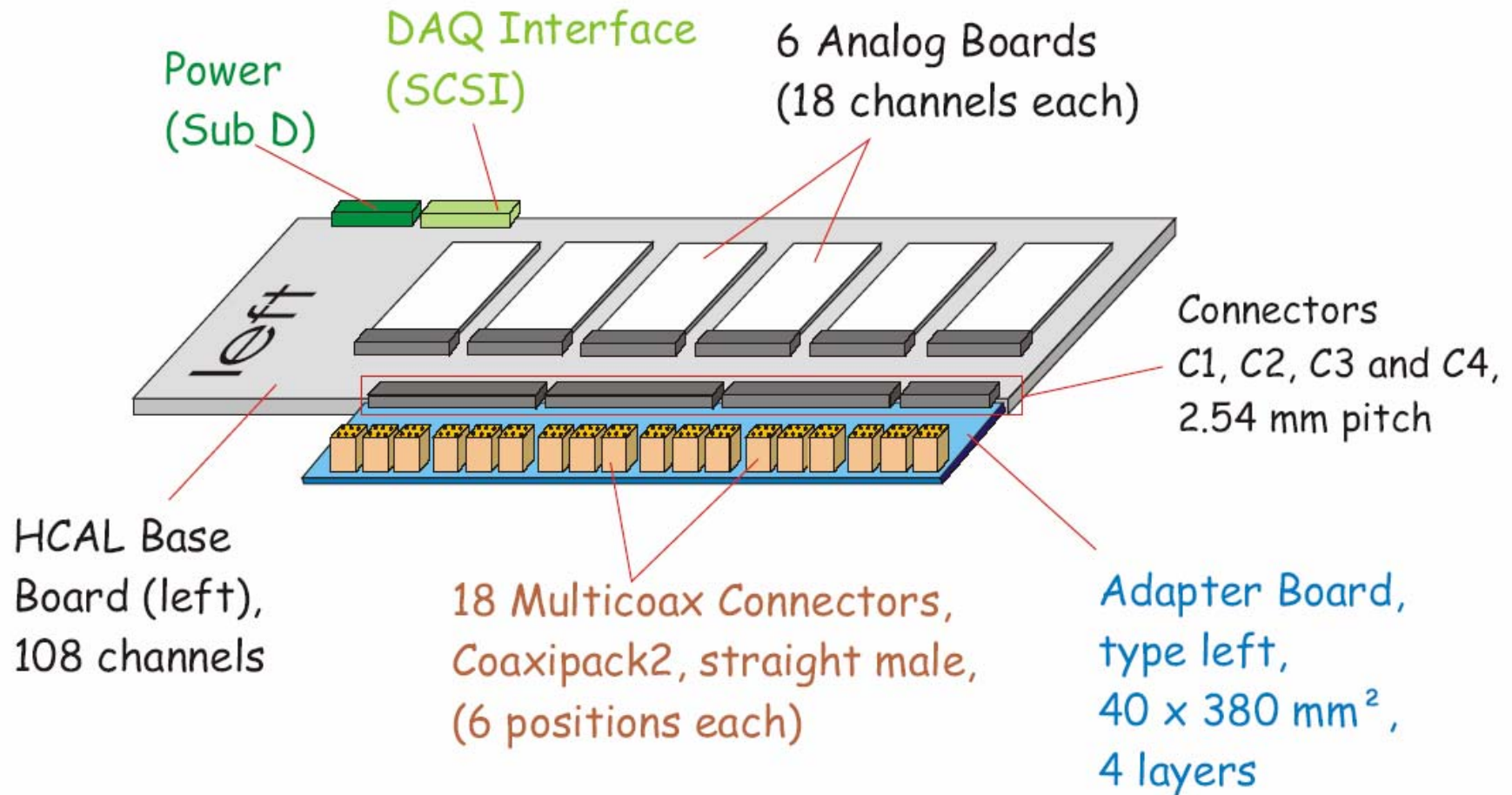

# TB: TCMT schedule for 2005

- Mar–Jun: QC for WLS fibers, first full cassette assembly, cut absorber plates.
- Jun–Aug: Continue cassette assembly, testing with baseboard, start full–chain commissioning.
- Sep–Nov: Start extended calibration, data taking with CR triggers, CR tests with all cassettes in place.

# Summary

- Simulations indicate (semi-) digital approach competitive with analog calorimetry
- Prototypes indicate there is sufficient sensitivity (light x efficiency) & uniformity.
- Now optimizing materials & construction to minimize cost with required sensitivity.
- SiPM and MRS photodetectors look very promising.
- Preparations for Tile HCal (analog) and TCMT in full swing.

**All-in-all scint looks like a competitive option.**

**We are moving toward the next prototype.**

# NIU/NICADD publications

1. MRS PHOTODIODE IN STRONG MAGNETIC FIELD FERMILAB-TM-2284, Dec 2004
2. SMALL SCINTILLATING CELLS AS THE ACTIVE ELEMENTS IN A DIGITAL HADRON CALORIMETER FOR THE  $e^+e^-$  LINEAR COLLIDER DETECTOR. A. Dyshkant et al. FERMILAB-PUB-04-015, Feb 2004. 11 pp  
Published in J.Phys.G30:N1,2004
3. THE DIGITAL HADRON CALORIMETER (DHC) ELEMENTS TEST. FERMILAB-FN-0733, Apr 2003
4. TOWARD A SCINTILLATOR-BASED DIGITAL HADRON CALORIMETER FOR THE LINEAR COLLIDER DETECTOR Published in IEEE Trans.Nucl.Sci.51:1590-1595,2004
5. About NICADD Extruded Scintillating Strips FERMILAB-PUB-05-010-E
6. INVESTIGATION OF A SOLID STATE PHOTODETECTOR Accepted for publication in NIM A