



Introduction to Finite-Element-Methods In Electromagnetism

Nathan S. Froemming (nfroemm@fnal.gov)

Northern Illinois University, PHYS 790D

Tue 08 Oct 2019

Main Goal for Today....

- Be able to understand, setup, and solve basic problems in electrostatics and magnetostatics using finite-element methods, e.g. “Finite Element Method Magnetics” (**FEMM**), on your local Windows/Linux/Mac computer

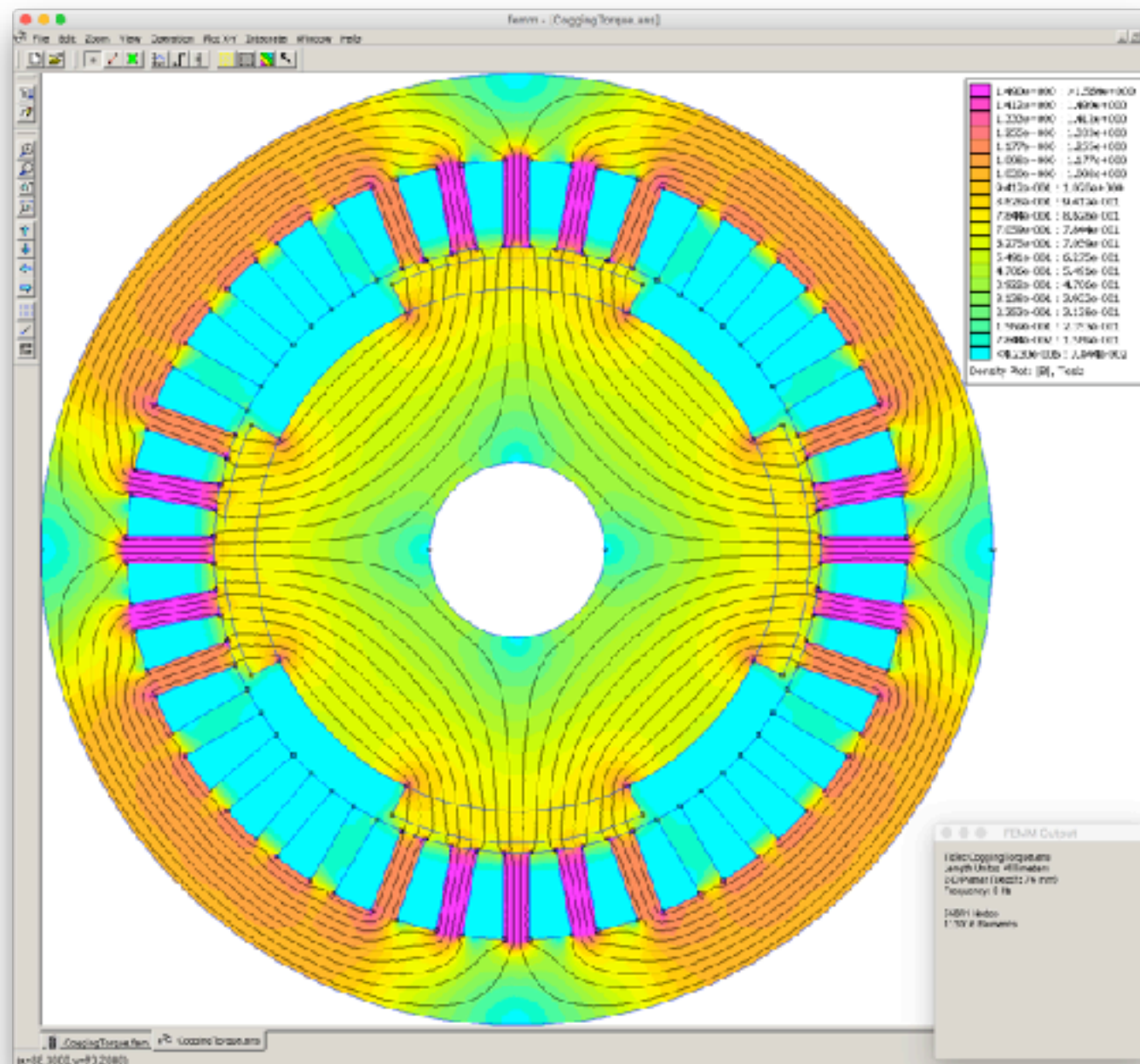

(quick real-time example)

Outline

- Overview Laplace's equation and solutions
 - Cauchy-Riemann equations; Connection to electromagnetism (EM)
 - Conformal mappings
 - Shortcomings
- Finite-Element methods and codes (OPERA, COMSOL, FEMM, ...)
- Getting FEMM setup on your local machine
- FEMM electric example
 - Problem setup: Electric dipole/quadrupole
 - How to extract the potential/E-field from FEMM
- FEMM magnetic example (next time)
 - Problem setup: H-dipole, quadrupole (more challenging)
 - How to extract the potential/B-field from FEMM
- Pro Tips And Tricks (next time)
 - Scripting in `lua` and `python`; Jupyter notebooks; WebPlotDigitizer; etc.
- Conclusions

But first, A Few Quick Words About Me....

- I am Prof. Syphers' postdoc. I am stationed at Fermilab, and I work closely with Accelerator Division (AD) and the Muon g-2 Experiment (E989)

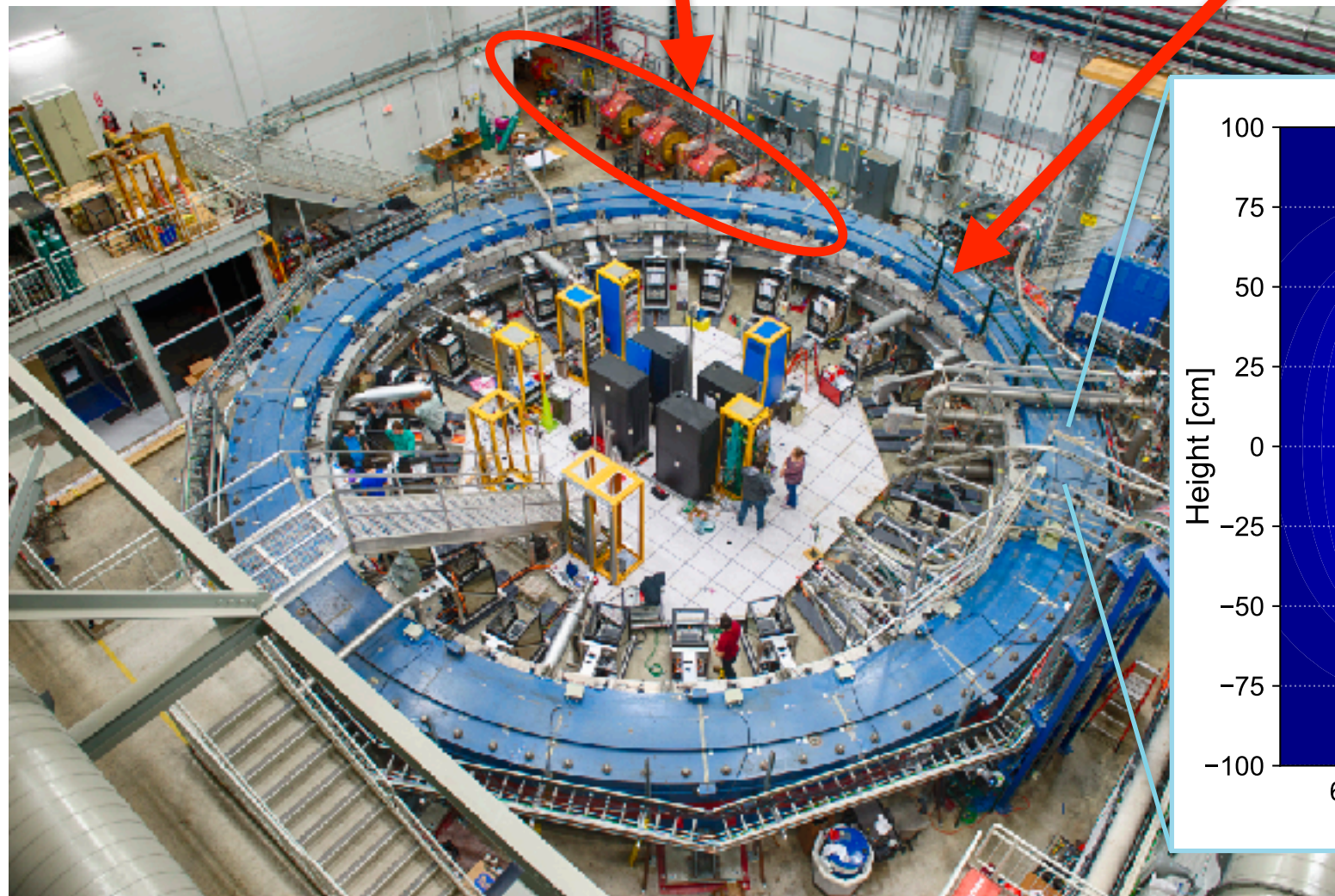

Example Finite-Element Field

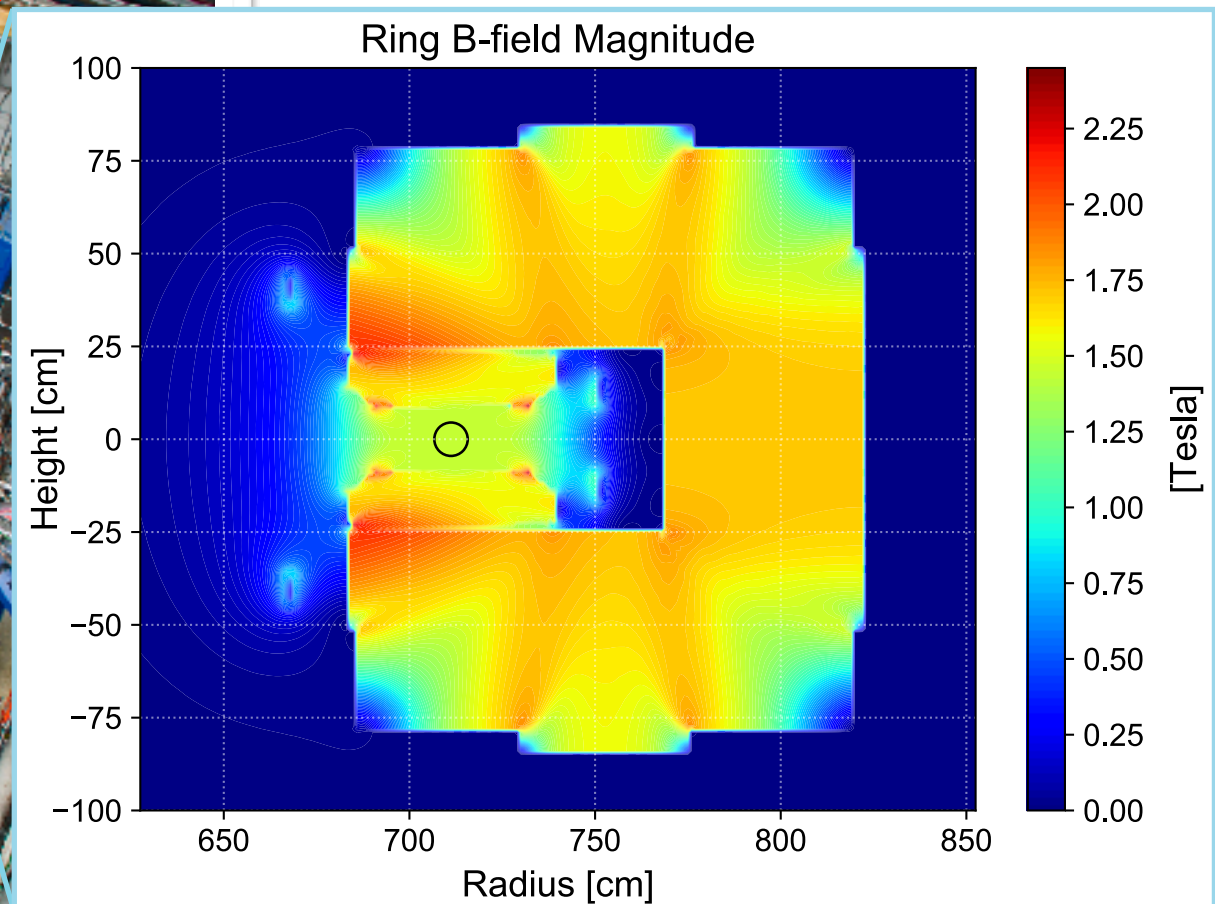

I'll Also Try To Talk About The Bigger Picture Along The Way

- [Accelerator] Physics has many applications elsewhere, e.g. medicine

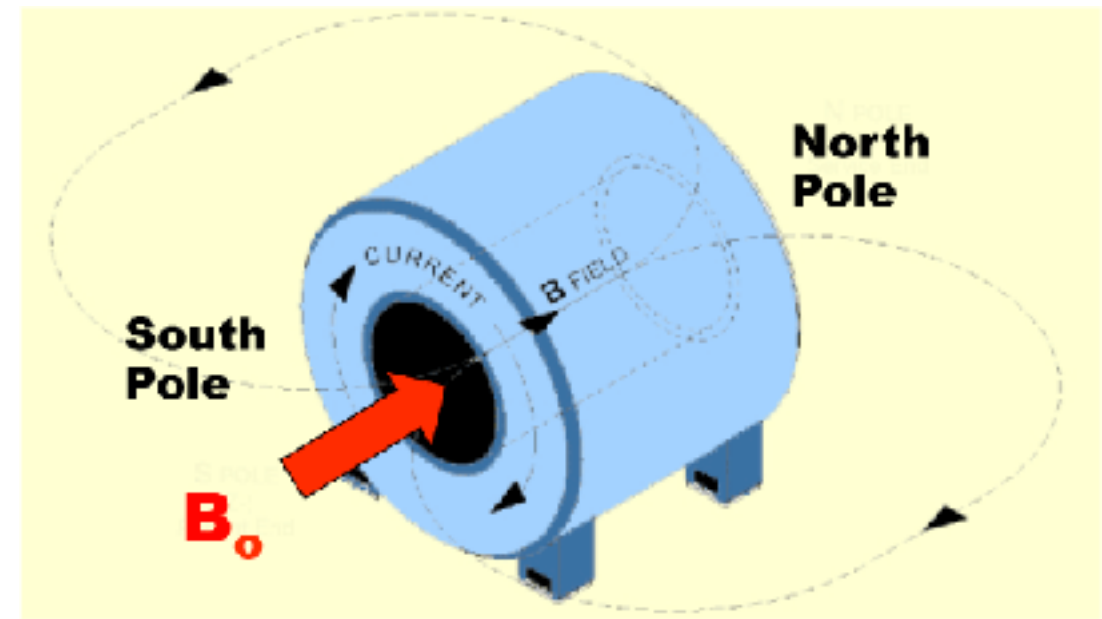

- The ability to perform high-level data analysis is always sought after!



Outline

- Overview Laplace's equation and solutions
 - Cauchy-Riemann equations; Connection to electromagnetism (EM)
 - Conformal mappings
 - Shortcomings
- Finite-Element methods and codes (OPERA, COMSOL, FEMM, ...)
- Getting FEMM setup on your local machine
- FEMM electric example
 - Problem setup: Electric dipole/quadrupole
 - How to extract the potential/E-field from FEMM
- FEMM magnetic example (next time)
 - Problem setup: H-dipole, quadrupole (more challenging)
 - How to extract the potential/B-field from FEMM
- Pro Tips And Tricks (next time)
 - Scripting in `lua` and `python`; Jupyter notebooks; WebPlotDigitizer; etc.
- Conclusions

Laplace's Equation

- In accelerator physics, most beamline elements (e.g. dipoles and quads) are static or slowly varying, so time-dependent terms in Maxwell's equations are zero or negligible

$$\begin{aligned}\nabla \cdot \mathbf{B} &= 0, & \nabla \times \mathbf{E} + \cancel{\frac{\partial \mathbf{B}}{\partial t}} &= \mathbf{0}, \\ \nabla \cdot \mathbf{E} &= \rho/\epsilon_0, & \nabla \times \mathbf{B} - \cancel{\frac{\partial \mathbf{E}}{\partial t}} &= \mu_0 \mathbf{j}.\end{aligned}$$

- Additionally, we try not to pass the beam through other material (beam pipe, pole tip, electrode), so Maxwell's equations simplify further:

$$\begin{aligned}\nabla \cdot \mathbf{B} &= 0, & \nabla \times \mathbf{E} &= \mathbf{0}, \\ \nabla \cdot \mathbf{E} &= 0, & \nabla \times \mathbf{B} &= \mathbf{0}.\end{aligned}$$

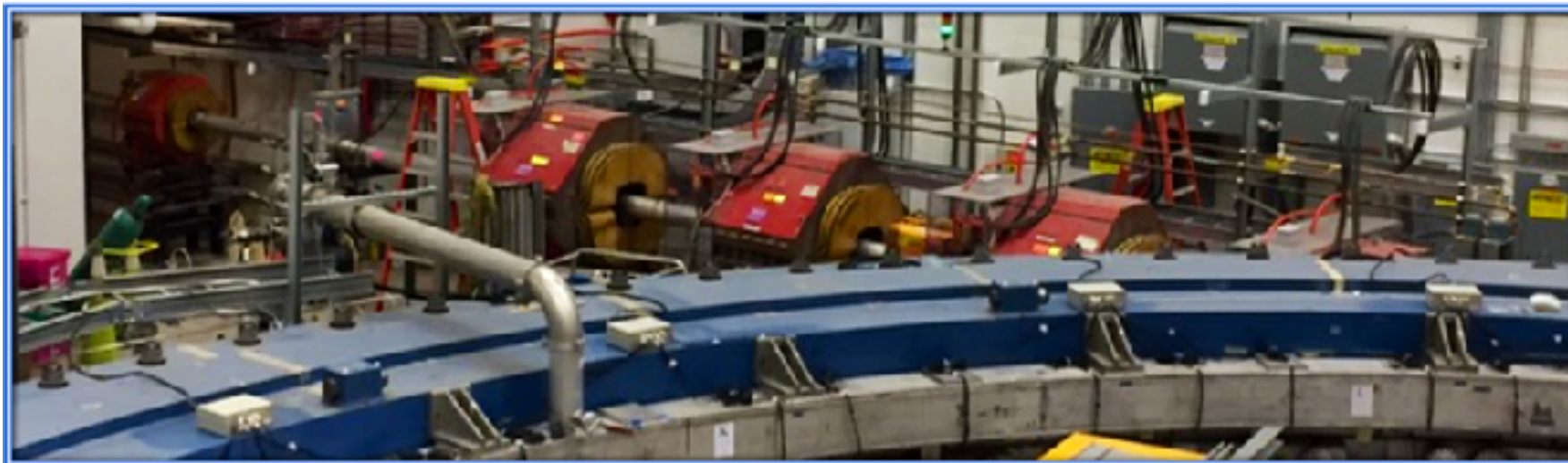

Laplace's Equation

- The curl equations imply the field may be derived from a potential,

$$\nabla \times \{\mathbf{E}, \mathbf{B}\} = \mathbf{0} \quad \Rightarrow \quad \{\mathbf{E}, \mathbf{B}\} = -\nabla \{V_e, V_m\}.$$

- The divergence equations then imply Laplace's equation,

$$\nabla \cdot \{\mathbf{E}, \mathbf{B}\} = \nabla \cdot (-\nabla \{V_e, V_m\}) = -\nabla^2 \{V_e, V_m\} = 0.$$

- Also, don't forget about these 3 copies of Laplace's equation,

$$\nabla \times \mathbf{B} = \nabla \times (\nabla \times \mathbf{A}) = \nabla(\nabla \cdot \mathbf{A}) - \nabla^2 \mathbf{A} = \mathbf{0} \quad \Rightarrow \quad -\nabla^2 \mathbf{A} = \mathbf{0}$$

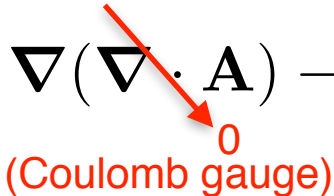
(Coulomb gauge)

- Laplace's equation is all over the place! We should spend some time trying to understand how to solve it....

Laplace's Equation

- EM fields are derivable from potentials. The complex plane really helps with the analysis...

$$f(z) = u(z) + iv(z), \quad z \equiv x + iy \in \mathbb{C}.$$

$$f'(z) \equiv \frac{\partial f}{\partial z} = \lim_{\Delta z \rightarrow 0} \frac{\Delta f}{\Delta z} = \lim_{\substack{\Delta x \rightarrow 0 \\ \Delta y \rightarrow 0}} \frac{\Delta u + i\Delta v}{\Delta x + i\Delta y}$$

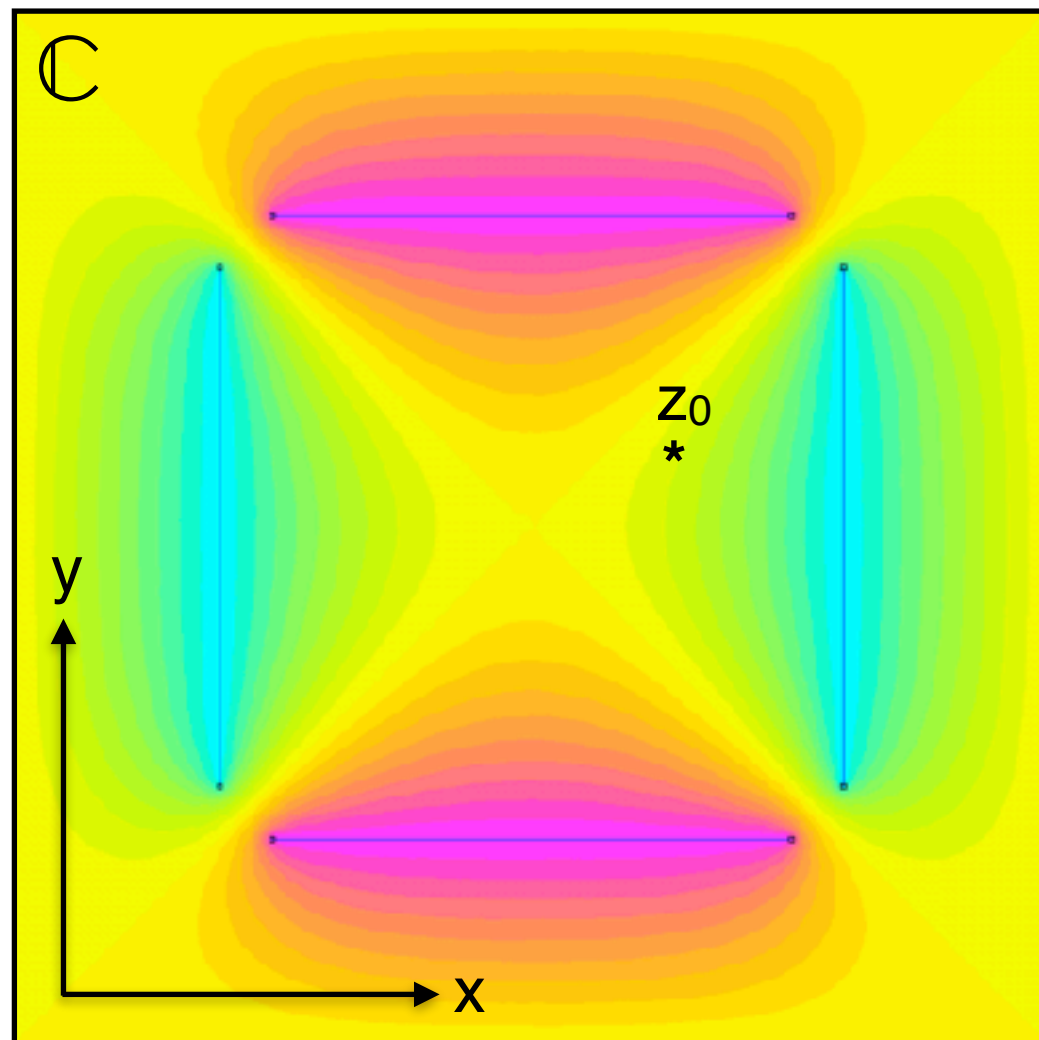

Suppose we have a particle here. We need to know the field (since $\mathbf{F} = q(\mathbf{E} + \mathbf{v} \times \mathbf{B})$), so we need to calculate a derivative of the potential

Laplace's Equation

- EM fields are derivable from potentials, and the complex plane really helps with the analysis:

$$f(z) = u(z) + iv(z), \quad z \equiv x + iy \in \mathbb{C}.$$

$$f'(z) \equiv \frac{\partial f}{\partial z} = \lim_{\Delta z \rightarrow 0} \frac{\Delta f}{\Delta z} = \lim_{\substack{\Delta x \rightarrow 0 \\ \Delta y = 0}} \frac{\Delta u + i\Delta v}{\Delta x + i\Delta y} = \frac{\partial u}{\partial x} + i \frac{\partial v}{\partial x}$$

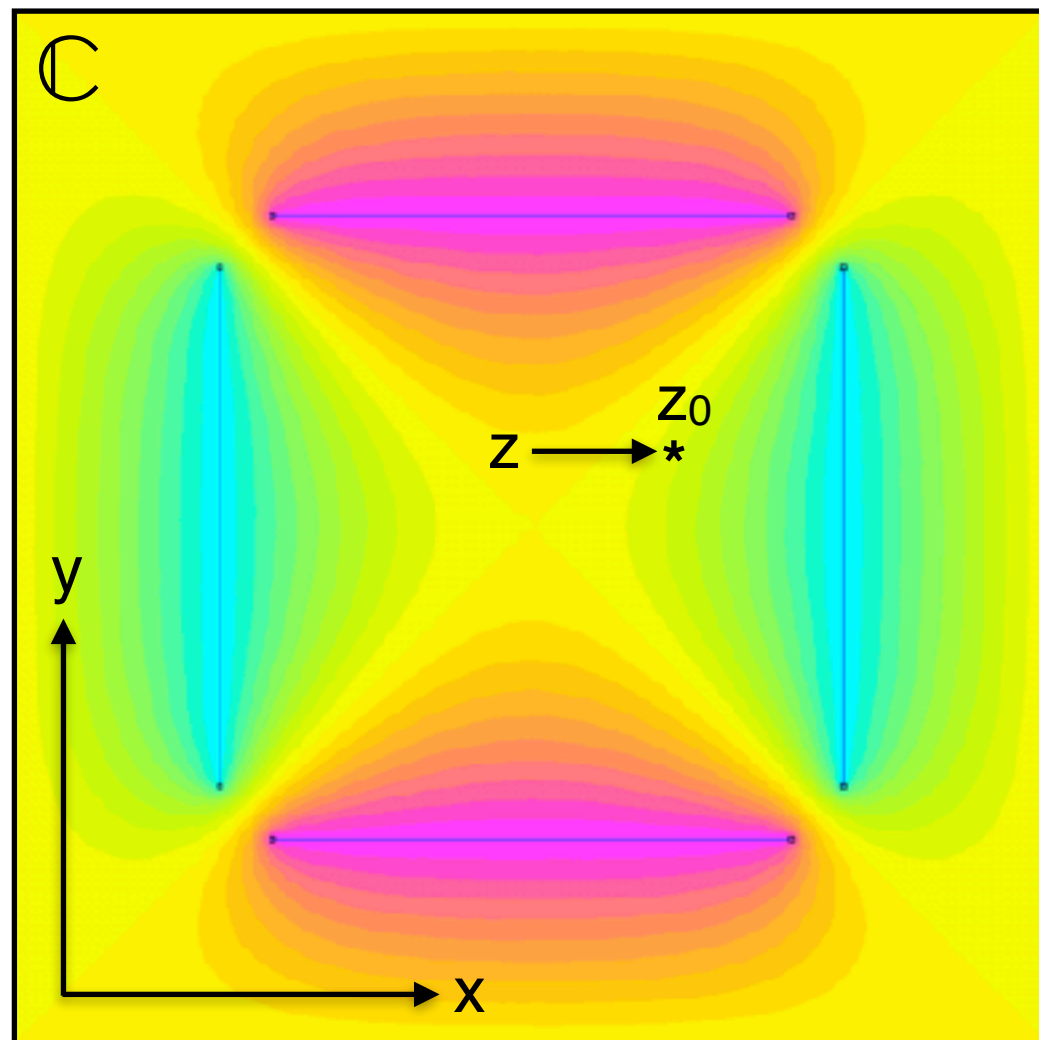

Approach1: Let $\Delta y = 0$, and approach z_0 purely along the x-direction....

Laplace's Equation

- EM fields are derivable from potentials, and the complex plane really helps with the analysis:

$$f(z) = u(z) + iv(z), \quad z \equiv x + iy \in \mathbb{C}.$$

$$f'(z) \equiv \frac{\partial f}{\partial z} = \lim_{\Delta z \rightarrow 0} \frac{\Delta f}{\Delta z} = \lim_{\substack{\Delta x \rightarrow 0 \\ \Delta y \rightarrow 0}} \frac{\Delta u + i\Delta v}{\Delta x + i\Delta y} = \frac{\partial v}{\partial y} - i \frac{\partial u}{\partial y}$$

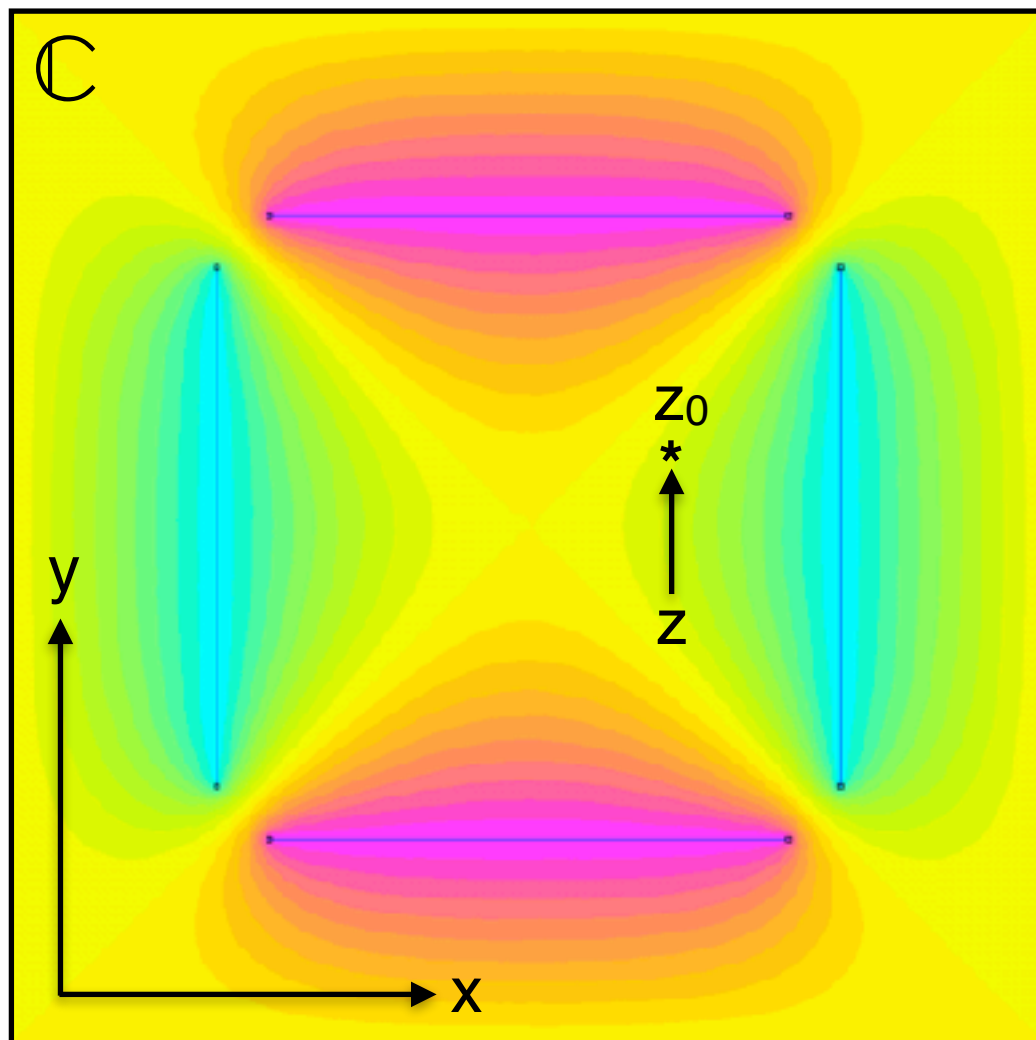

Approach2: Now let $\Delta x = 0$, and approach z_0 purely along the y-direction

Laplace's Equation

- EM fields are derivable from potentials, and the complex plane really helps with the analysis:

$$f(z) = u(z) + iv(z), \quad z \equiv x + iy \in \mathbb{C}.$$

$$f'(z) \equiv \frac{\partial f}{\partial z} = \lim_{\Delta z \rightarrow 0} \frac{\Delta f}{\Delta z} = \lim_{\substack{\Delta x \rightarrow 0 \\ \Delta y \rightarrow 0}} \frac{\Delta u + i\Delta v}{\Delta x + i\Delta y} = \frac{\partial v}{\partial y} - i \frac{\partial u}{\partial y}$$

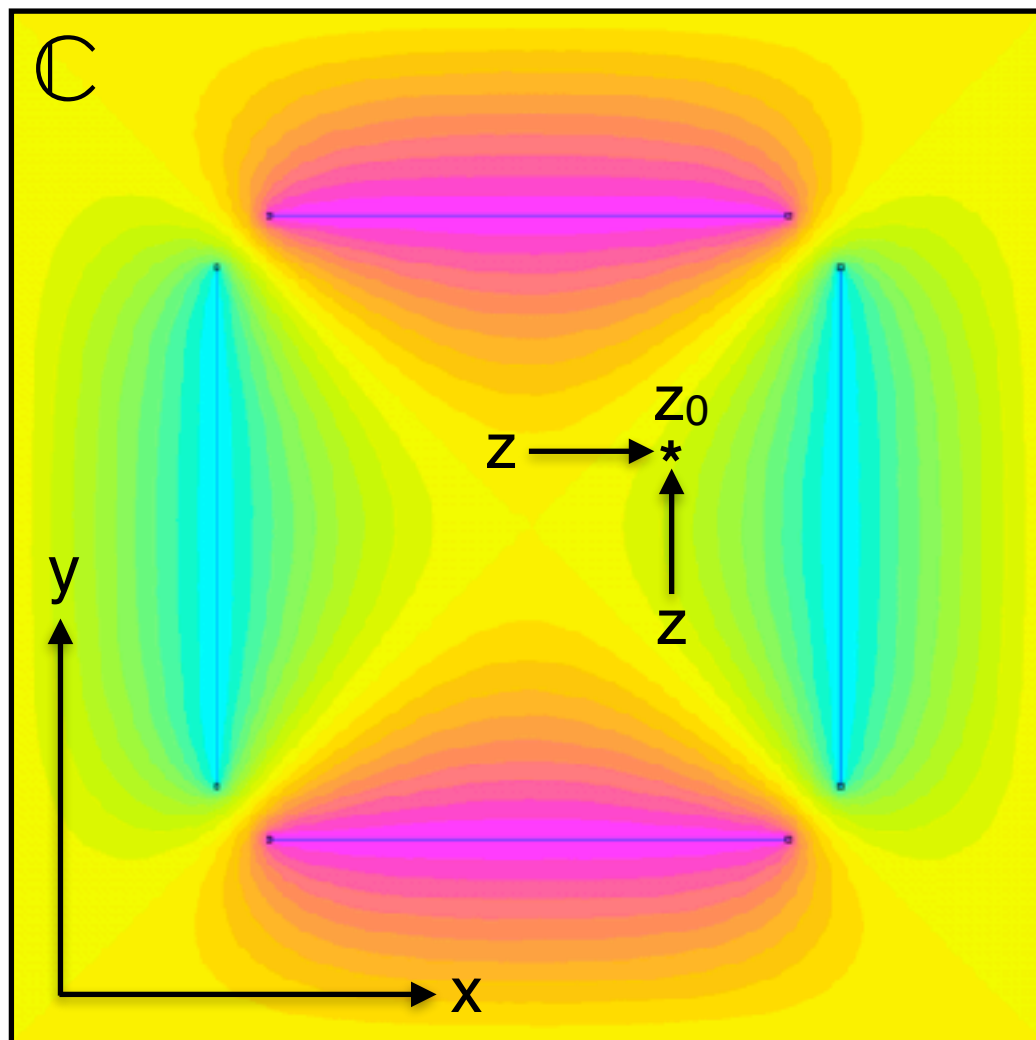

If the derivative of $f(z)$ exists, the two approaches outlined above must give the same result!

Equating the real and the imaginary parts of the equations on the last two slides, we get the celebrated Cauchy-Riemann equations! 😊

$$\frac{\partial u}{\partial x} = + \frac{\partial v}{\partial y}, \quad \frac{\partial u}{\partial y} = - \frac{\partial v}{\partial x}.$$

Laplace's Equation

- The Cauchy-Riemann equations are deeply connected to Laplace's equation

$$f(z) = u(z) + iv(z), \quad z \equiv x + iy \in \mathbb{C}.$$

$$\boxed{\frac{\partial u}{\partial x} = +\frac{\partial v}{\partial y}, \quad \frac{\partial u}{\partial y} = -\frac{\partial v}{\partial x}.$$

Cauchy-Riemann (CR)

- The Cauchy-Riemann (CR) equations imply two separate copies of Laplace's equations, one for both the real and the imaginary parts of $f(z)$!

$$\partial_x^2 u = \partial_x(\partial_x u) = \partial_x(\partial_y v) = \partial_y(\partial_x v) = -\partial_y^2 u \quad \Rightarrow \quad \boxed{-(\partial_x^2 + \partial_y^2)u = 0}$$

$$\partial_y^2 v = \partial_y(\partial_y v) = \partial_y(\partial_x u) = \partial_x(\partial_y u) = -\partial_x^2 v \quad \Rightarrow \quad \boxed{-(\partial_x^2 + \partial_y^2)v = 0}.$$

- On Thursday, we'll talk more about multipole expansions, $f(z) = \sum c_n \cdot z^n$

Conformal Transformations

- Conformal transformations of the complex plane are basically functions that preserve orientation and angles locally (“conformal”)

Example from [Mathematica](#)

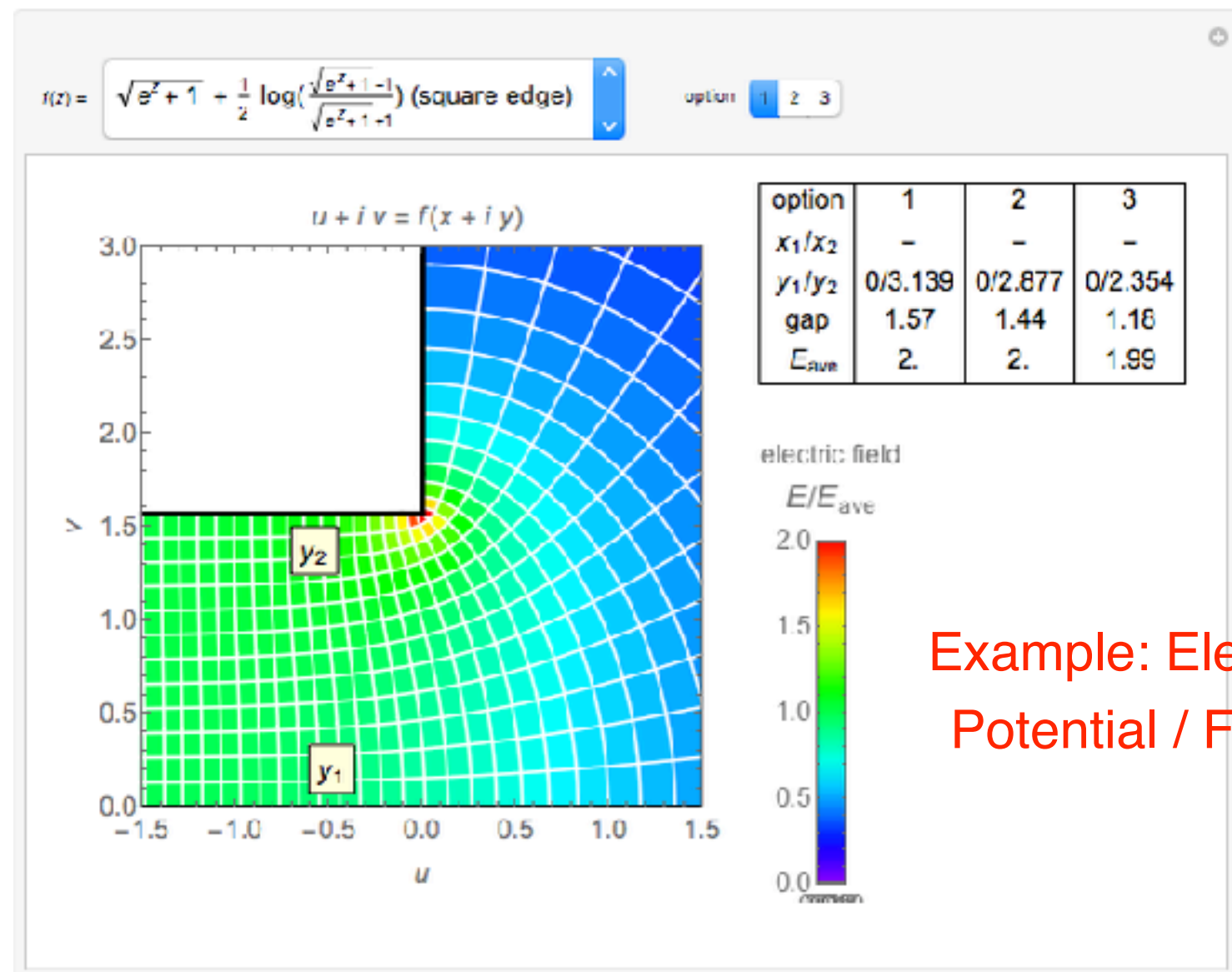
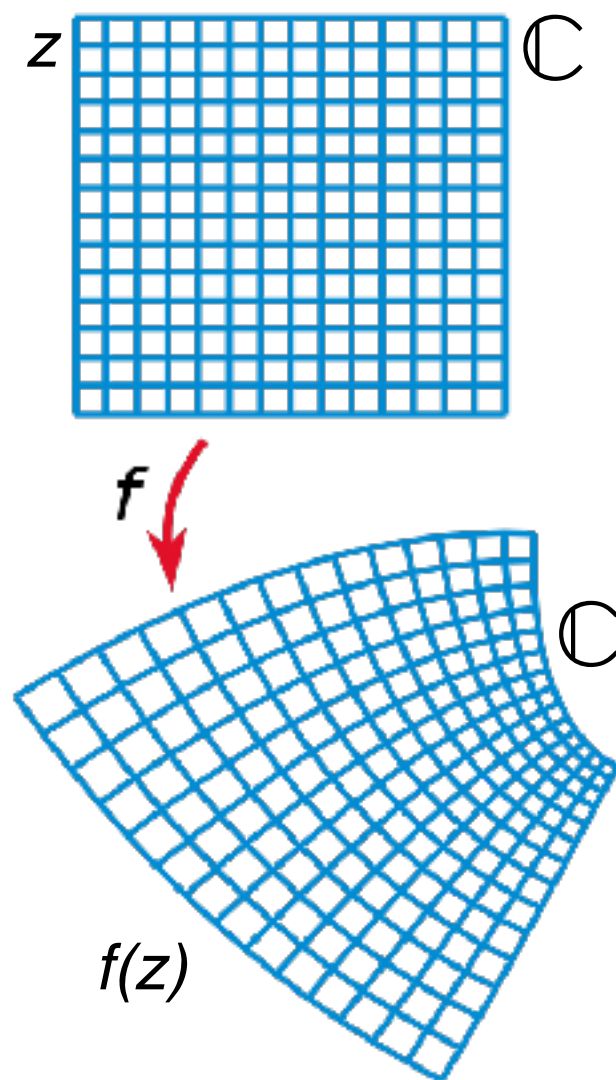

Example: Electric Potential / Field

Conformal Transformations \Rightarrow Finite-Element Methods

- Mathematical expressions quickly get out of control. Limited to all but this simplest cases. Nowadays, with computers, we can do much more....

Conformal transformations
(i.e. math equations on paper)
were basically superseded by
numerical methods on
computers c. 1960-1970

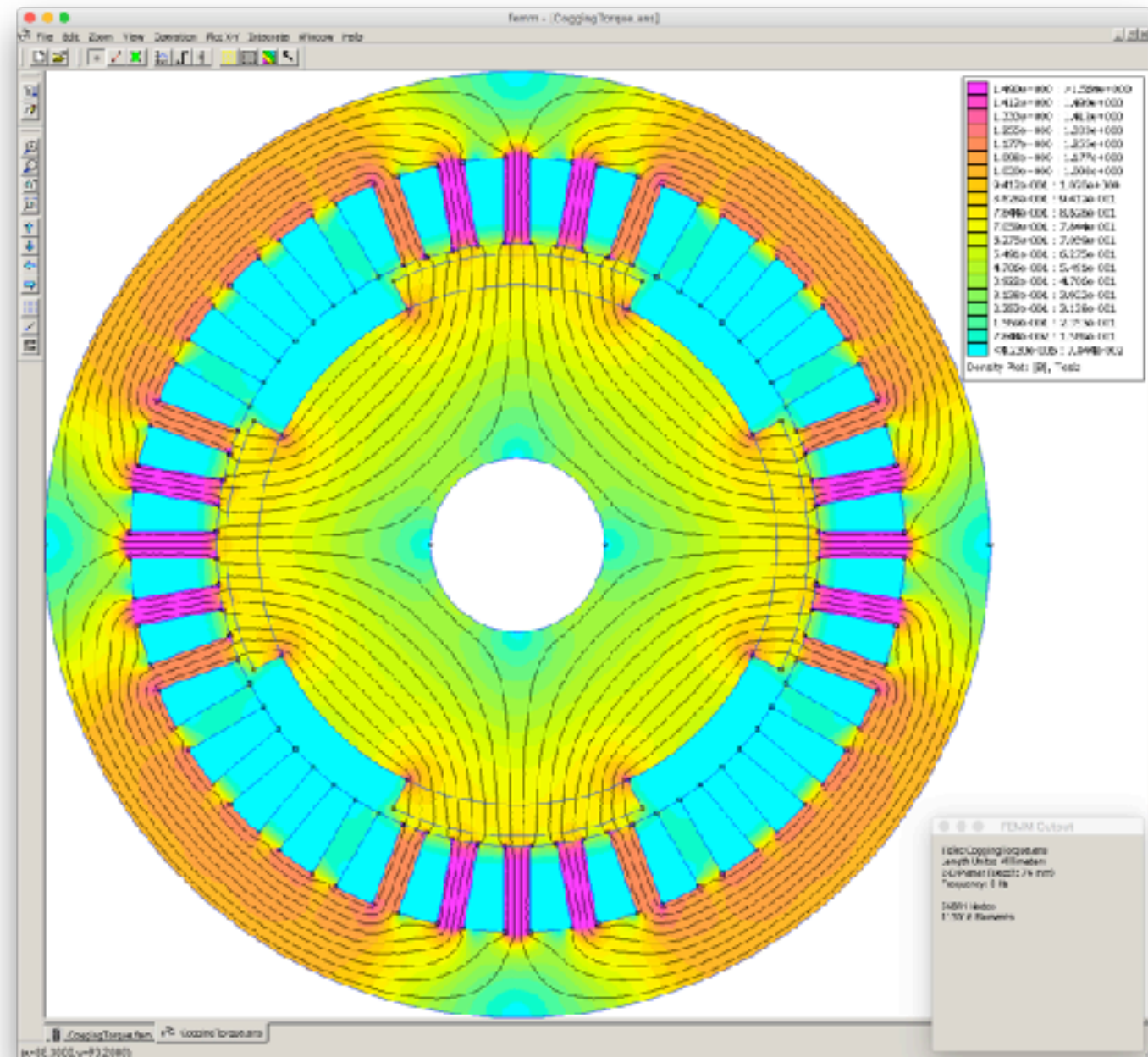

Finite-Element Methods (FEM)?

- Essentially, (FEM) “puts differential equations on a grid/mesh” and solves numerically with computers (fluid flow, heat flow, stress/strain, electromagnetism, etc.)

“Finite Elements”
(a.k.a. “mesh”)

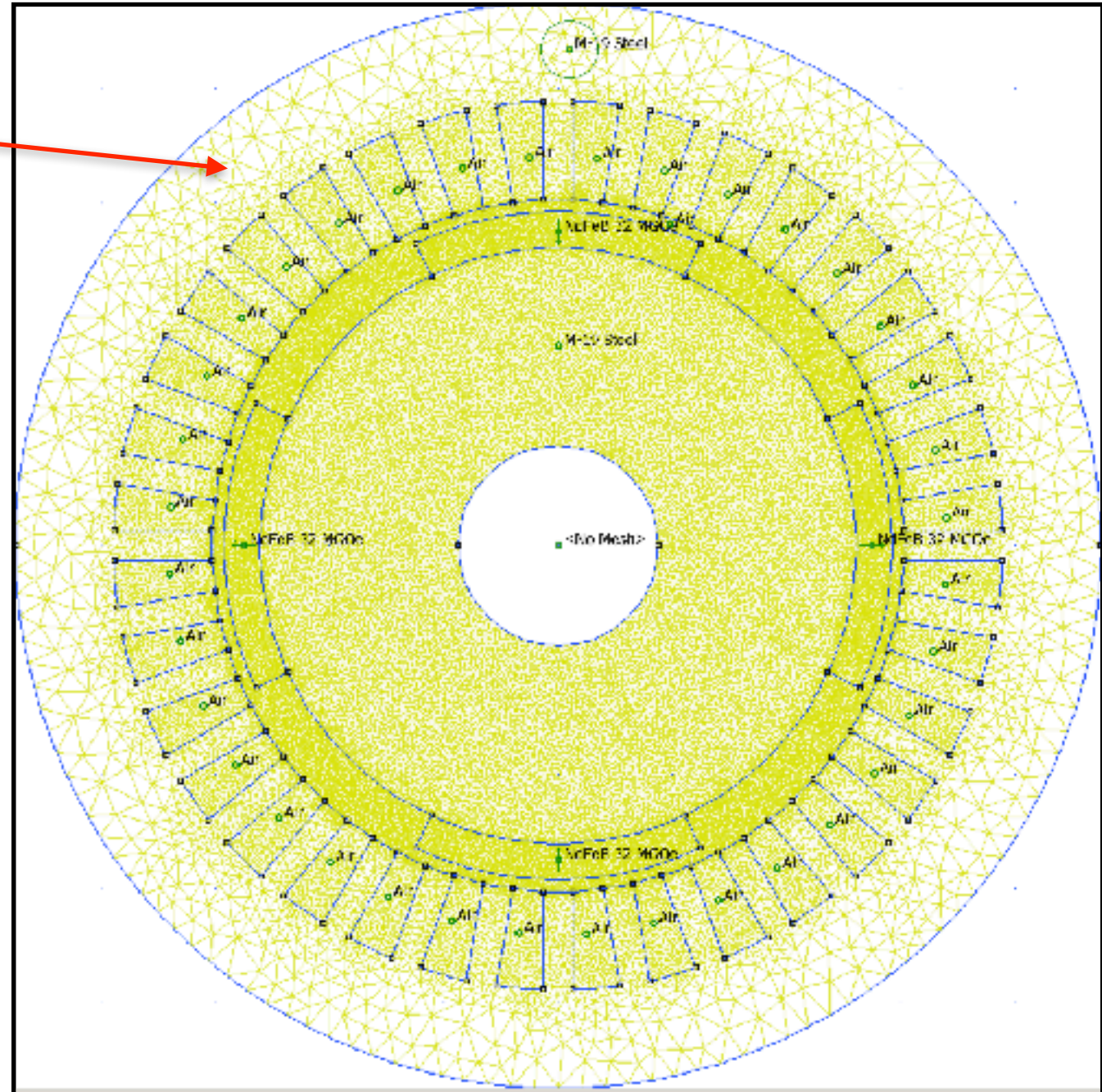
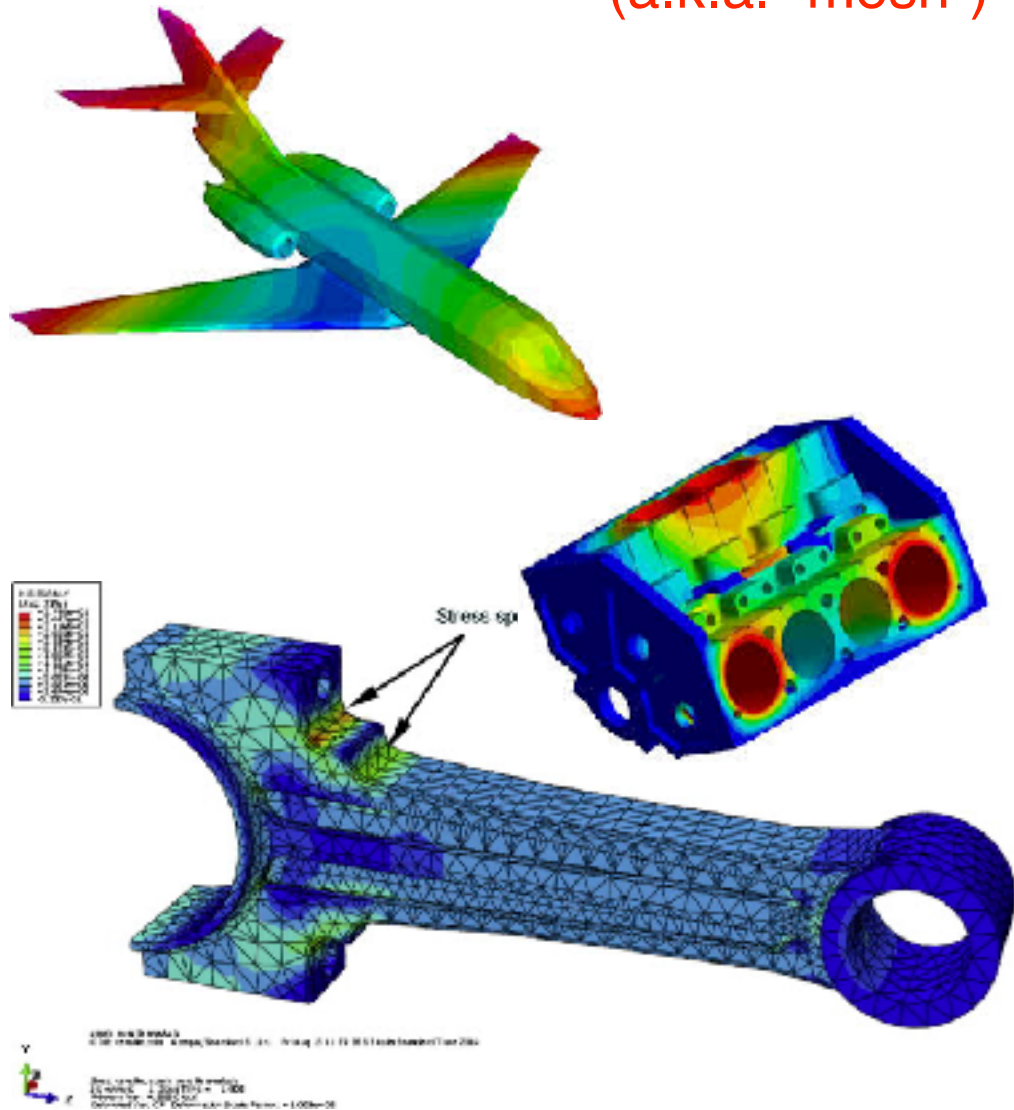

Finite-Element Methods (FEM): Laplace's equation

- A simple example of solving Laplace's equation via "grid relaxation"

Problem domain ("mesh")

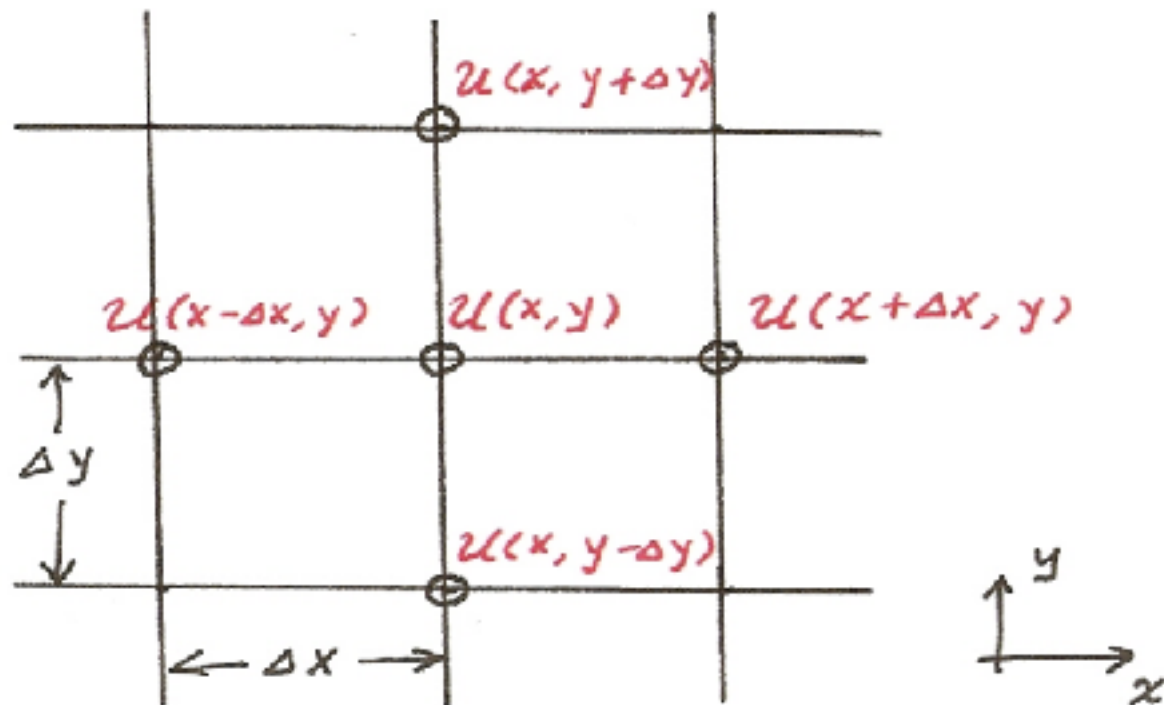

Laplace's equation on the grid

$$\left(\frac{\partial^2 u}{\partial x^2}\right) \approx \frac{u(x - \Delta x, y) - 2u(x, y) + u(x + \Delta x, y)}{(\Delta x)^2},$$

$$\left(\frac{\partial^2 u}{\partial y^2}\right) \approx \frac{u(x, y - \Delta y) - 2u(x, y) + u(x, y + \Delta y)}{(\Delta y)^2}.$$

(quick derivation on the board)

Finite-Element Methods (FEM): Laplace's equation

- We can rewrite the last slide using “index notation”

Problem domain (“mesh”)

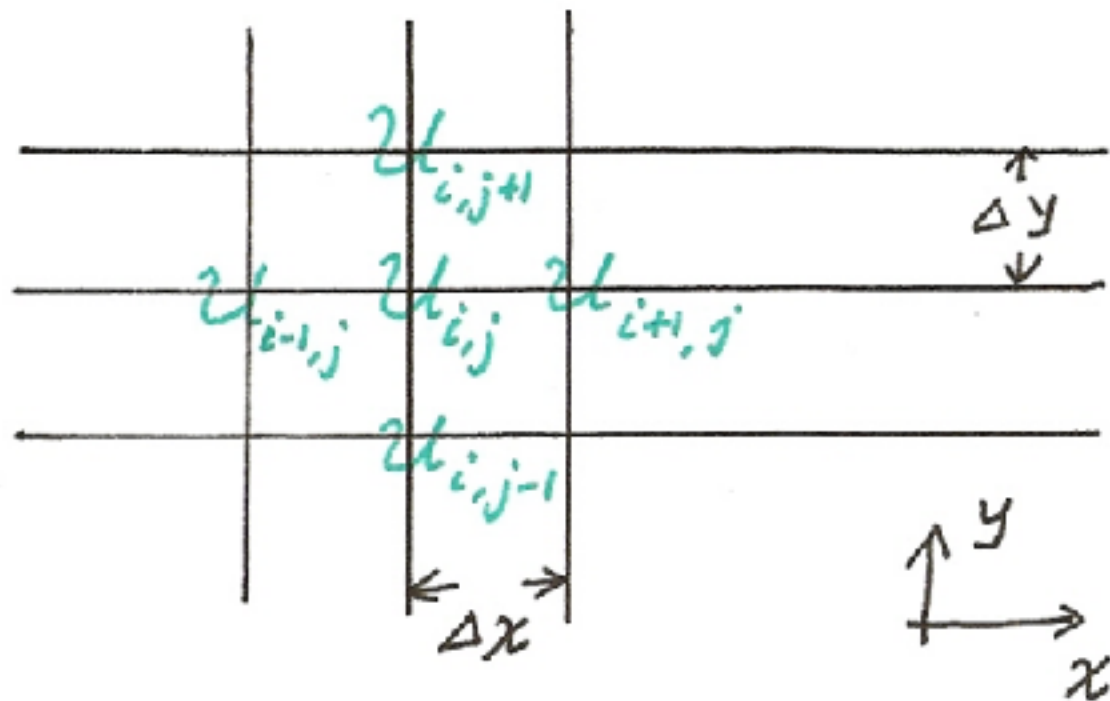

Laplace's equation on the grid, $u(i, j)$

$$\frac{u_{i-1,j} - 2u_{i,j} + u_{i+1,j}}{(\Delta x)^2} + \frac{u_{i,j-1} - 2u_{i,j} + u_{i,j+1}}{(\Delta y)^2} = 0$$

(this is the same equation as on the last slide)

Finite-Element Methods (FEM): Laplace's equation

- Let $\Delta x = \Delta y = 1$ for simplicity. Then the solution at $u(i, j)$ is just the average value of its neighbors!

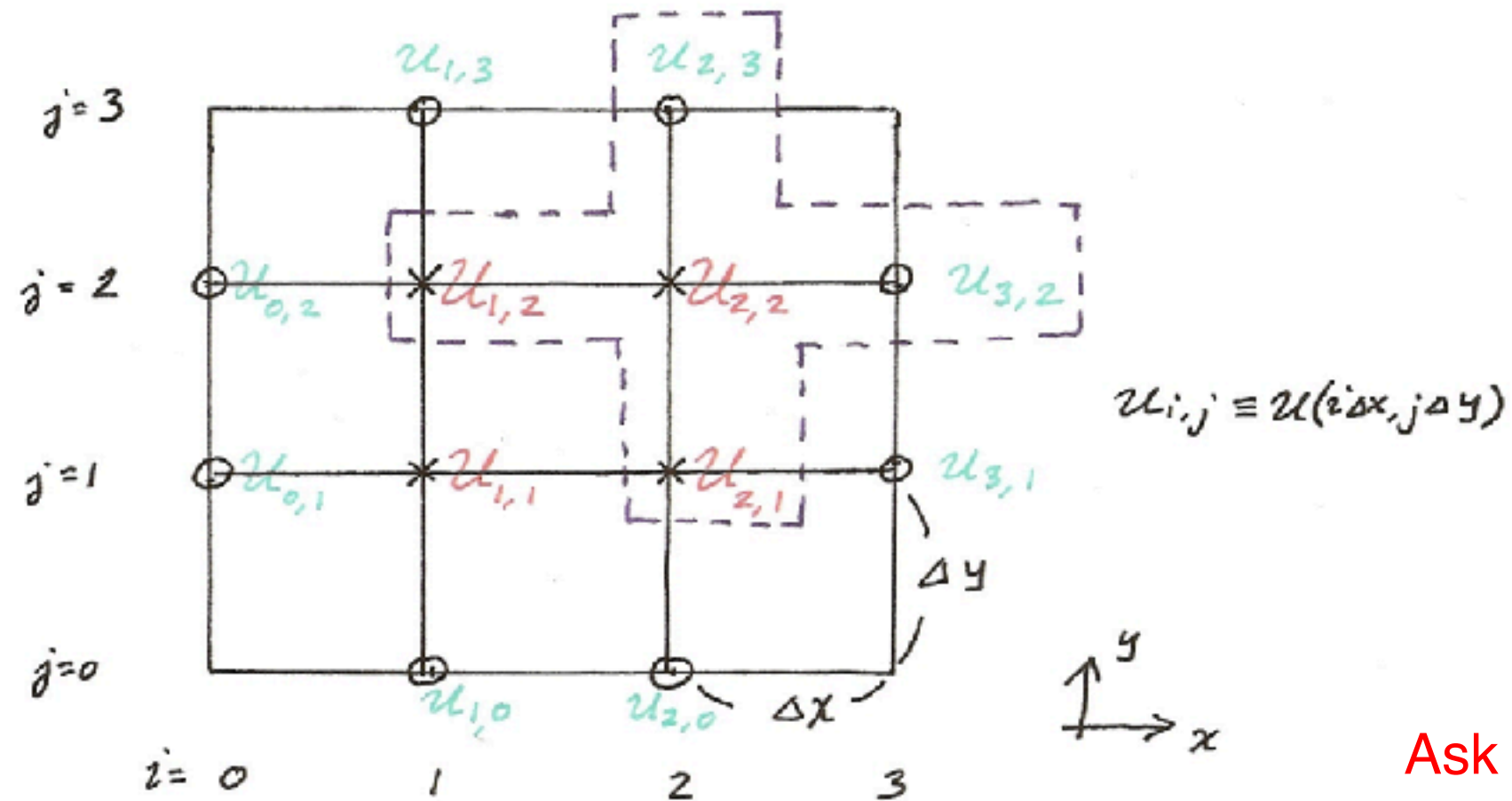

Ask to see Prof.
Syphers' notebook :)

$$-4u_{2,2} + u_{1,2} + u_{2,1} + \underbrace{u_{2,3} + u_{3,2}}_{\text{known from B.C.}} = 0$$

Outline

- Overview Laplace's equation and solutions
 - Cauchy-Riemann equations; Connection to electromagnetism (EM)
 - Conformal mappings
 - Shortcomings
- Finite-Element methods and codes (OPERA, COMSOL, FEMM, ...)
- Getting FEMM setup on your local machine
- FEMM electric example
 - Problem setup: Electric dipole/quadrupole
 - How to extract the potential/E-field from FEMM
- FEMM magnetic example (next time)
 - Problem setup: H-dipole, quadrupole (more challenging)
 - How to extract the potential/B-field from FEMM
- Pro Tips And Tricks (next time)
 - Scripting in `lua` and `python`; Jupyter notebooks; WebPlotDigitizer; etc.
- Conclusions

Getting FEMM Setup On Your Local Windows/Linux/Mac

- Instructions at the PHYS 790D course website ([here](#))
- Windows installation is very easy
- Linux/Mac installation requires one additional step: [Wine](#)

FEMM (a Windows application)

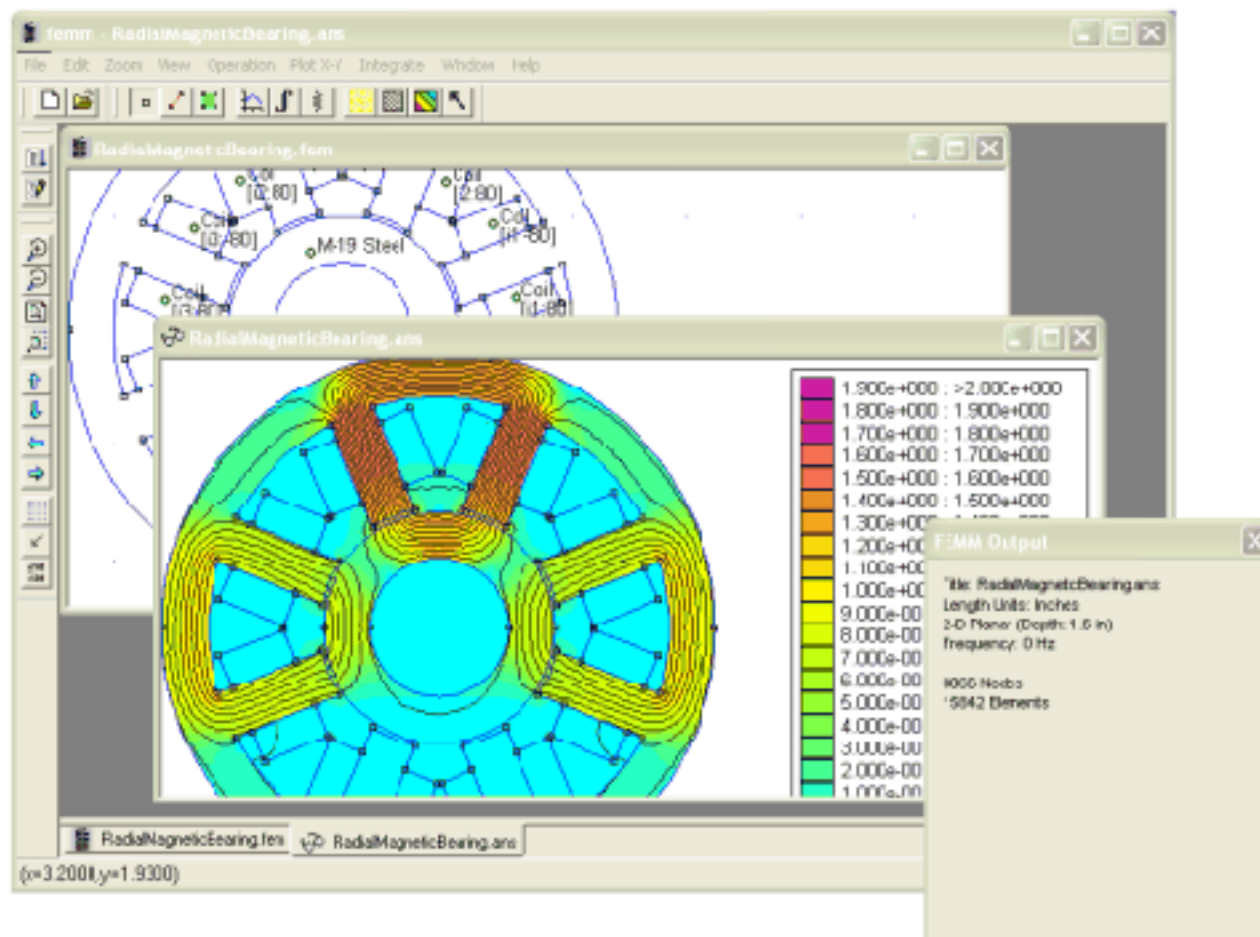

WINE allows you to run Windows Apps on your Linux/Mac!

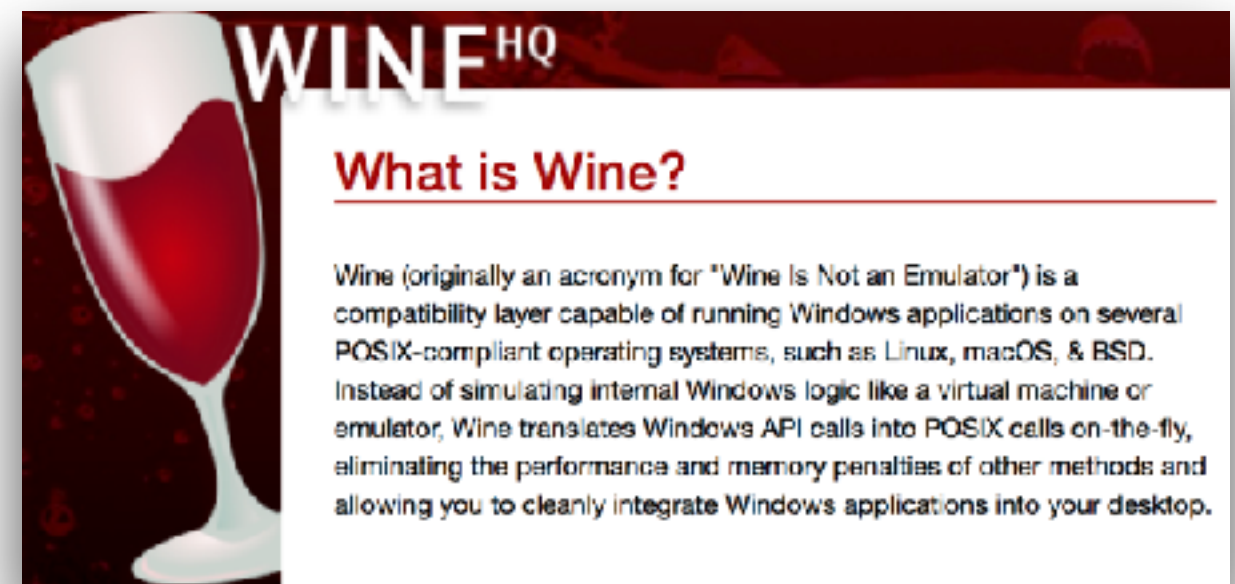

FEMM Tutorial: Electrostatics

- Electric problems are easier to setup in FEMM, so that's where we'll start
- Two simple examples: (1) electric dipole, (2) electric quadrupole

Electric storage ring: EDM measurements

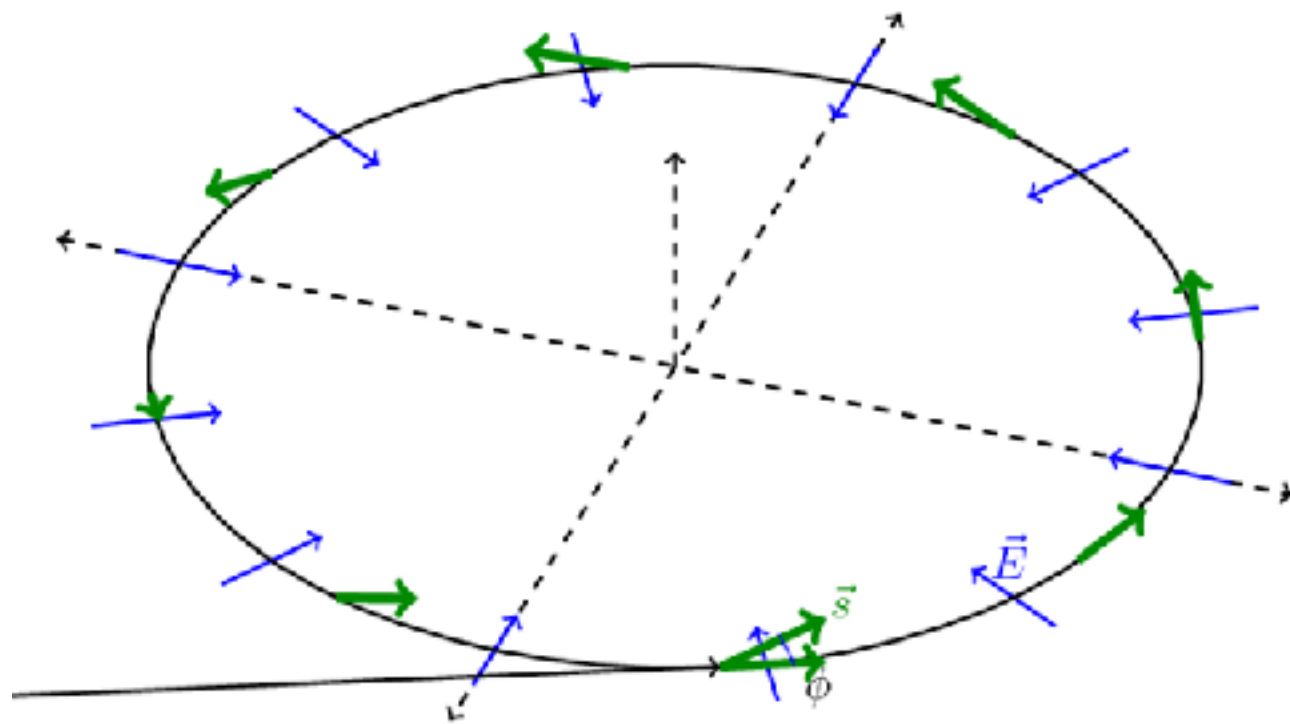

Example electric dipole FEMM simulation

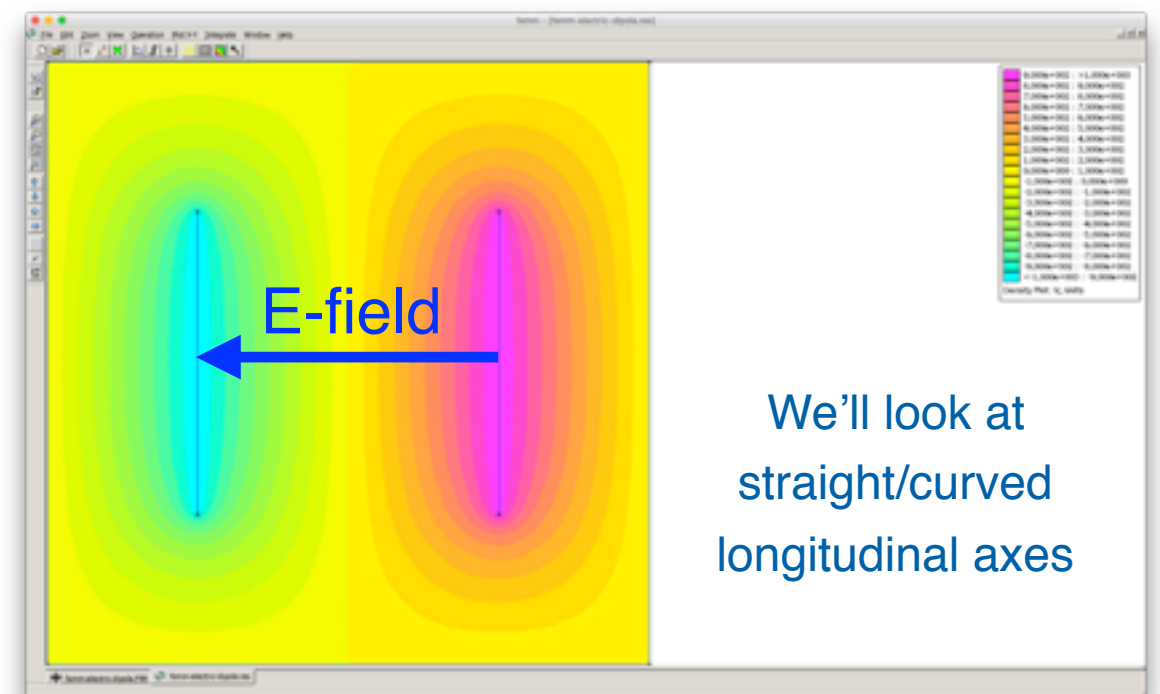

FEMM Tutorial: Electrostatics

- Here we go! Start FEMM and create a new “Electrostatics Problem”

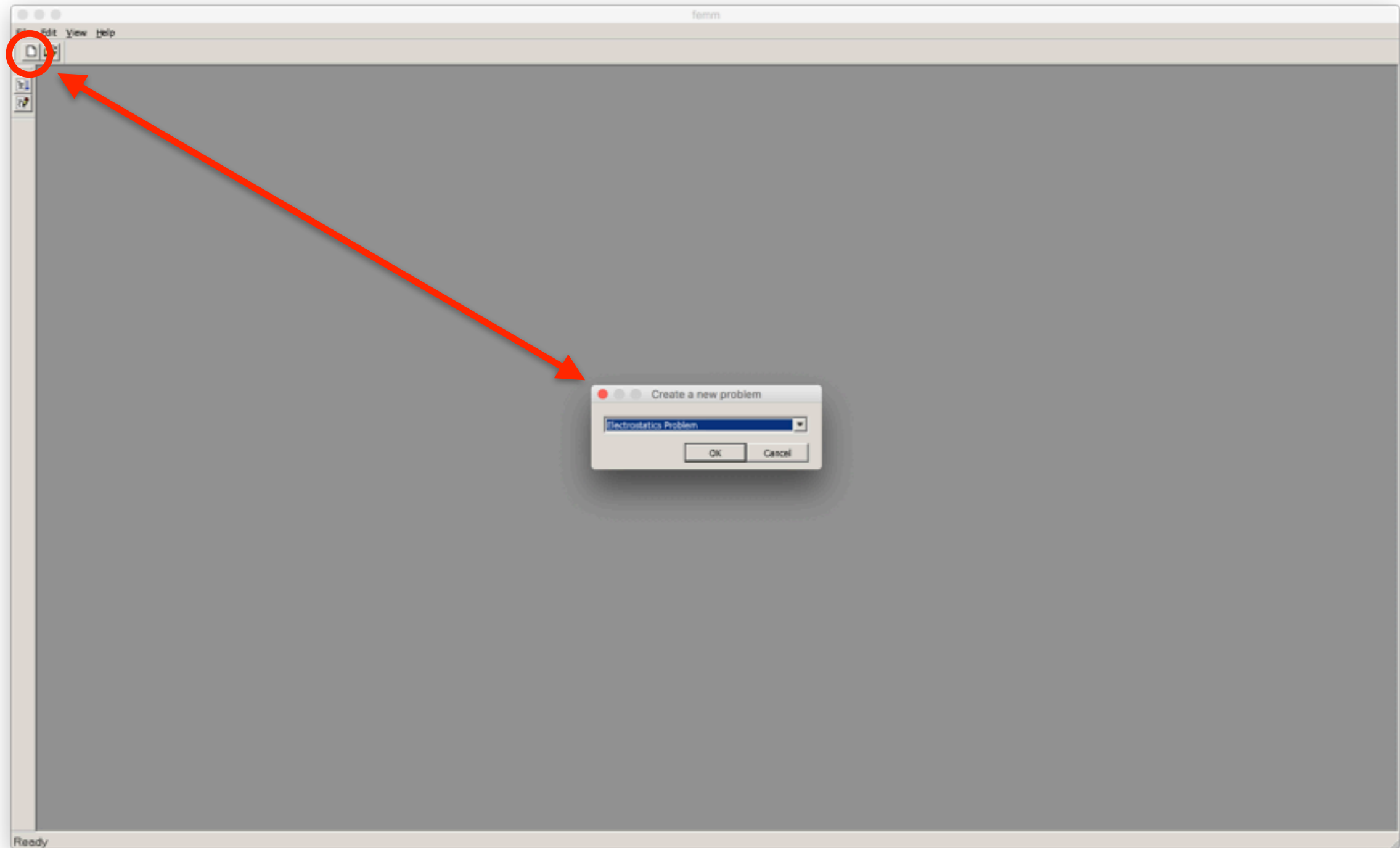

FEMM Tutorial: Electrostatics

- Can define global properties of the FEMM simulation here

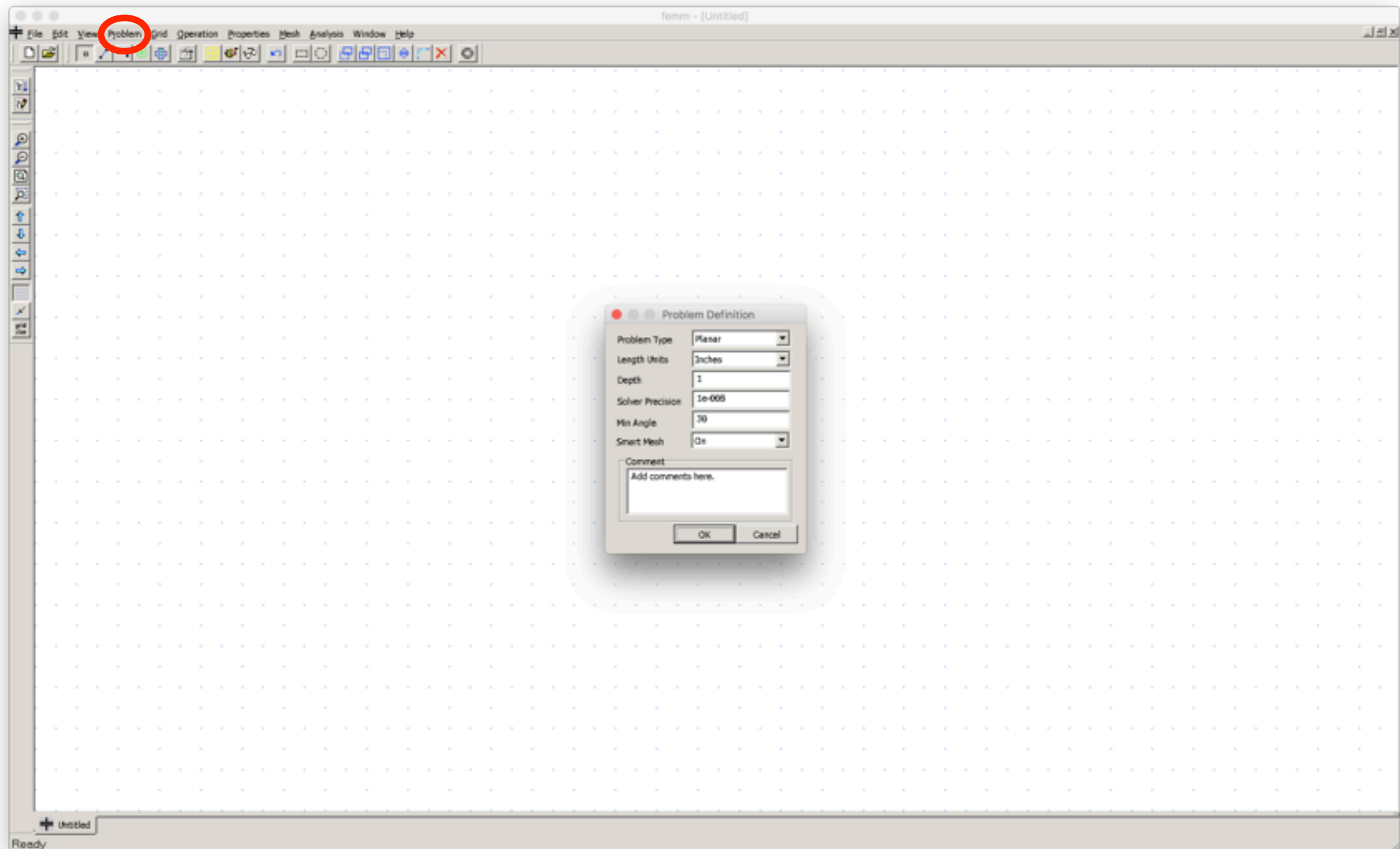

FEMM Tutorial: Electrostatics

- Always save your work! (I chose filename = “femm-electric-dipole”)

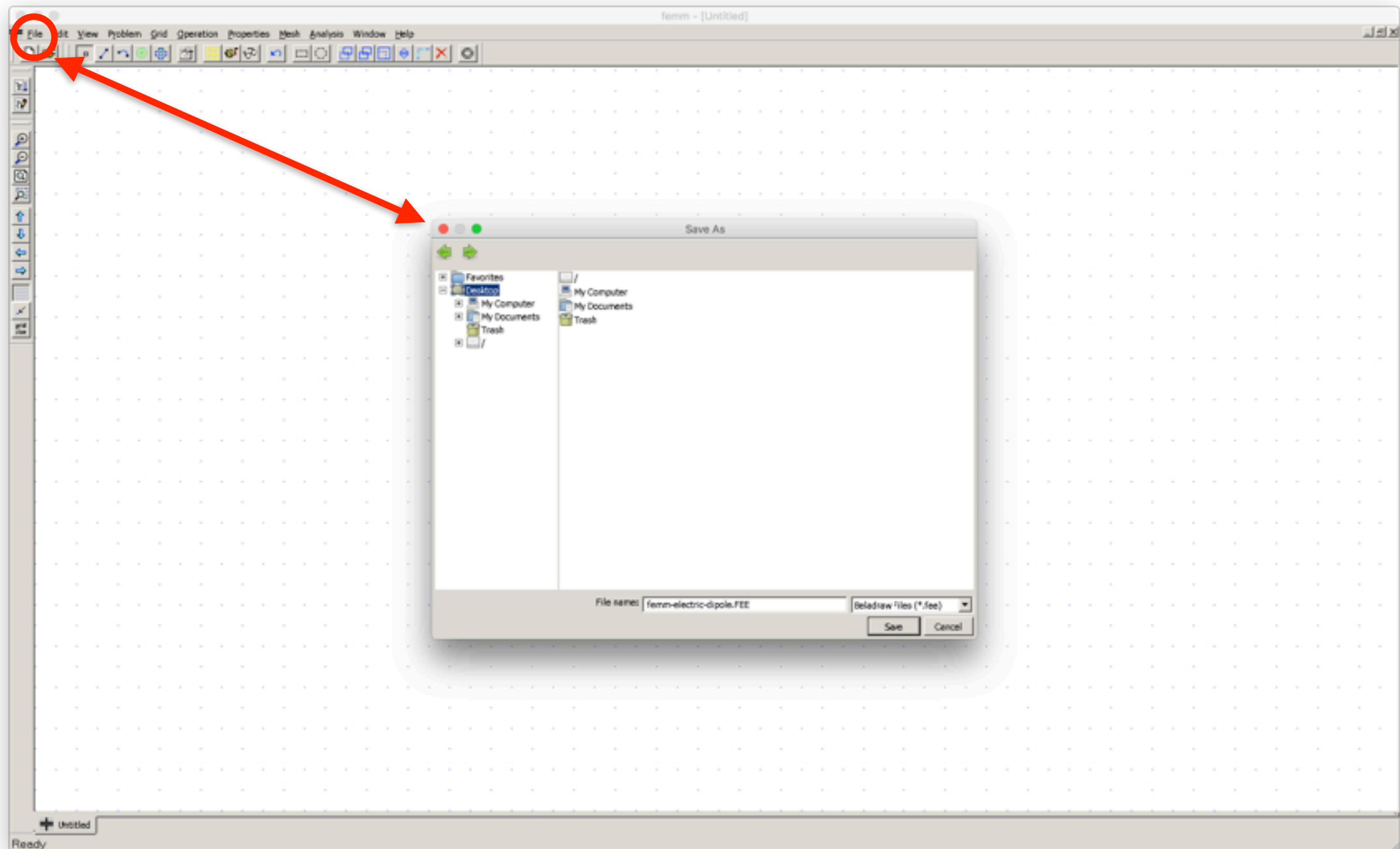

FEMM Tutorial: Electrostatics

- Build a “vacuum chamber” shape. Start by defining corners & edges

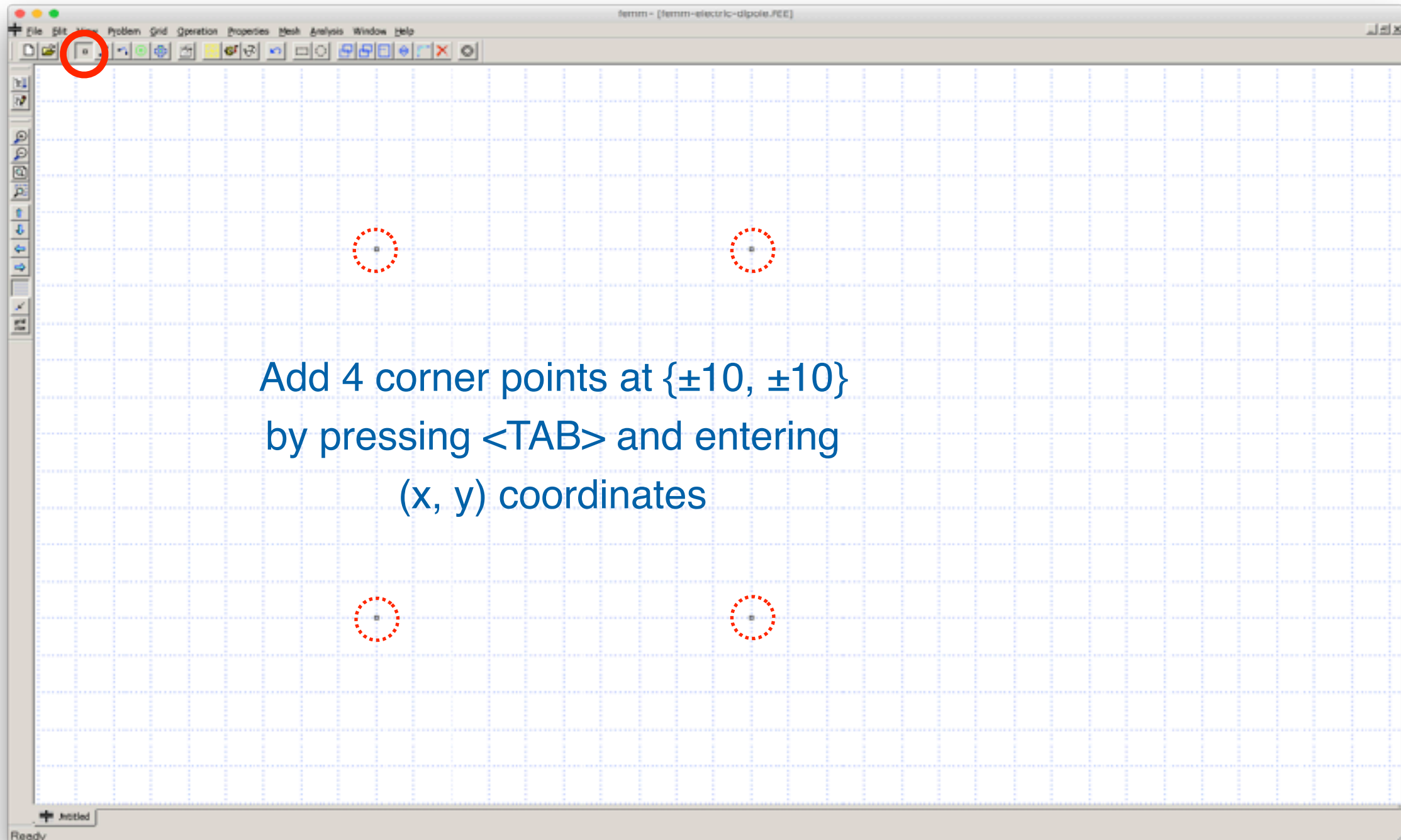

FEMM Tutorial: Electrostatics

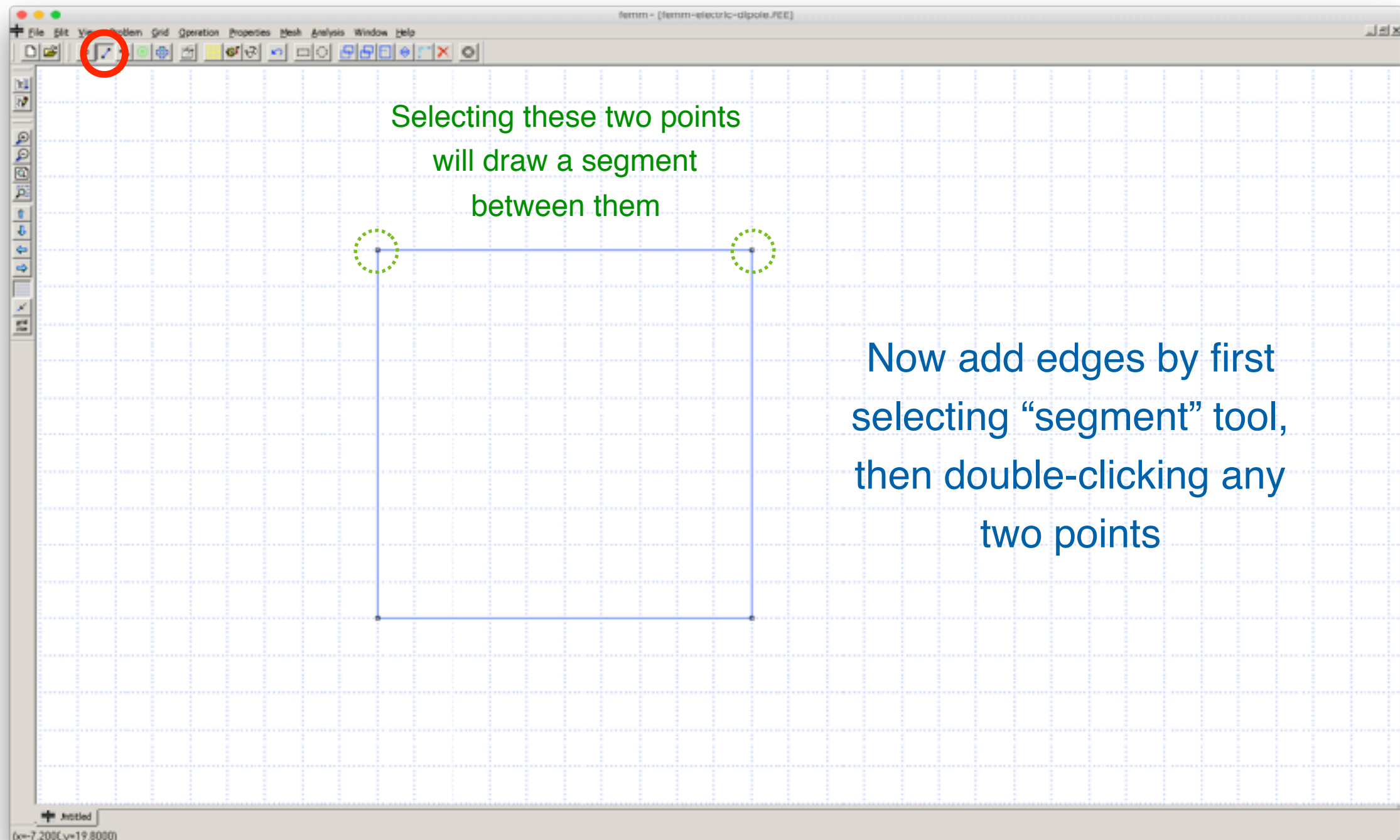

FEMM Tutorial: Electrostatics

- The vacuum chamber is at 0V — add a boundary condition

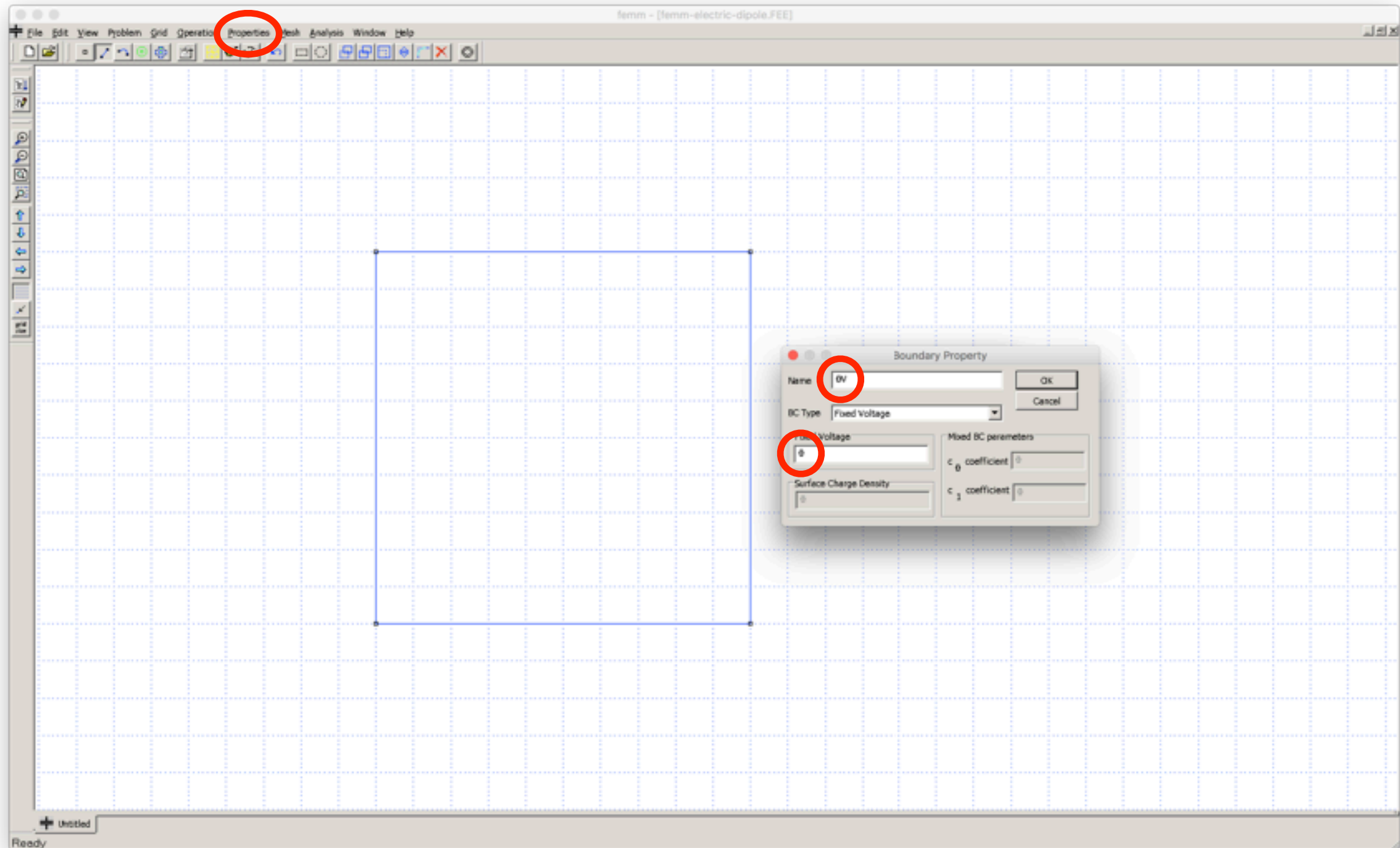

FEMM Tutorial: Electrostatics

- The vacuum chamber is at 0V — add a boundary condition

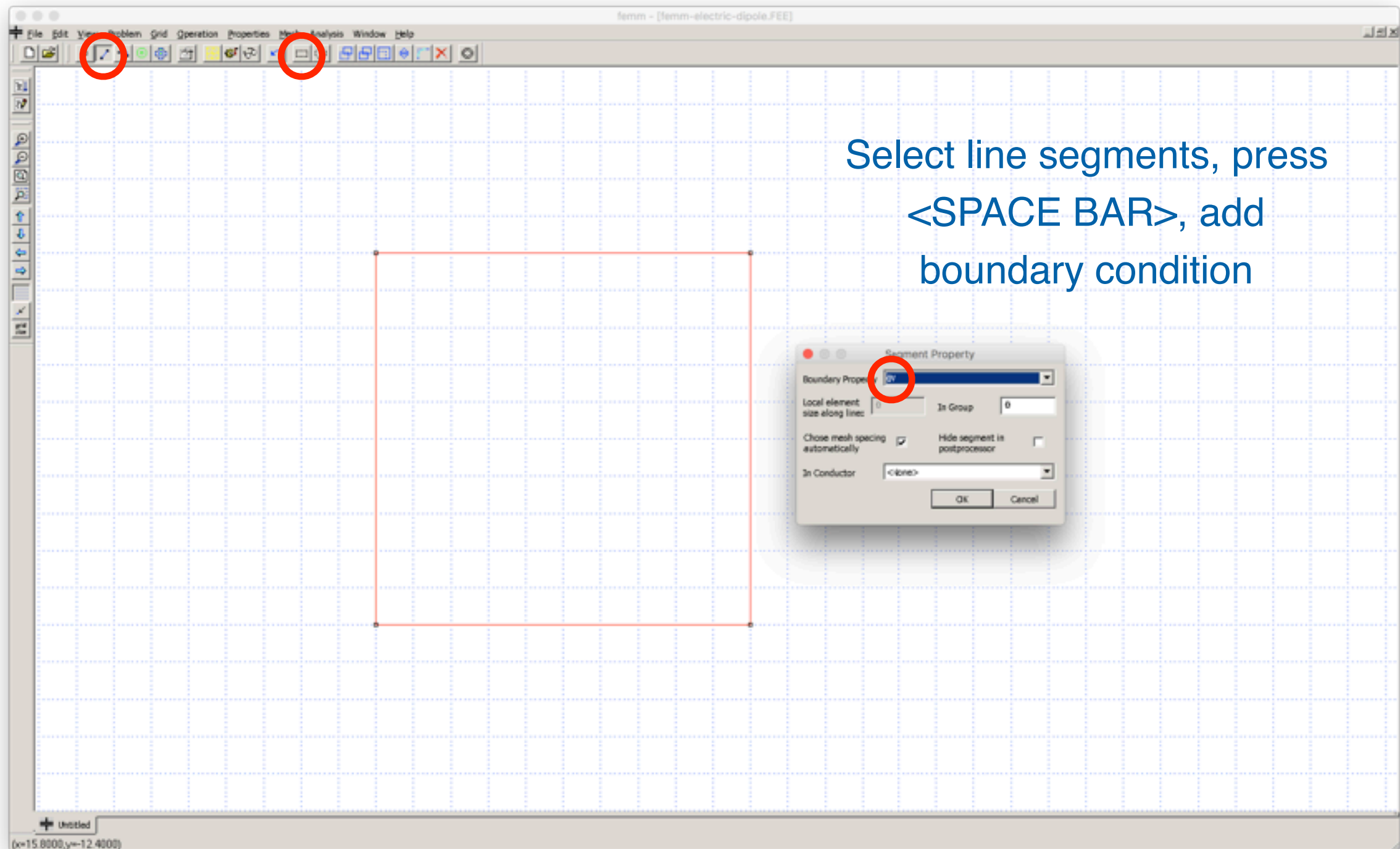

FEMM Tutorial: Electrostatics

- Add material, “Vacuum”

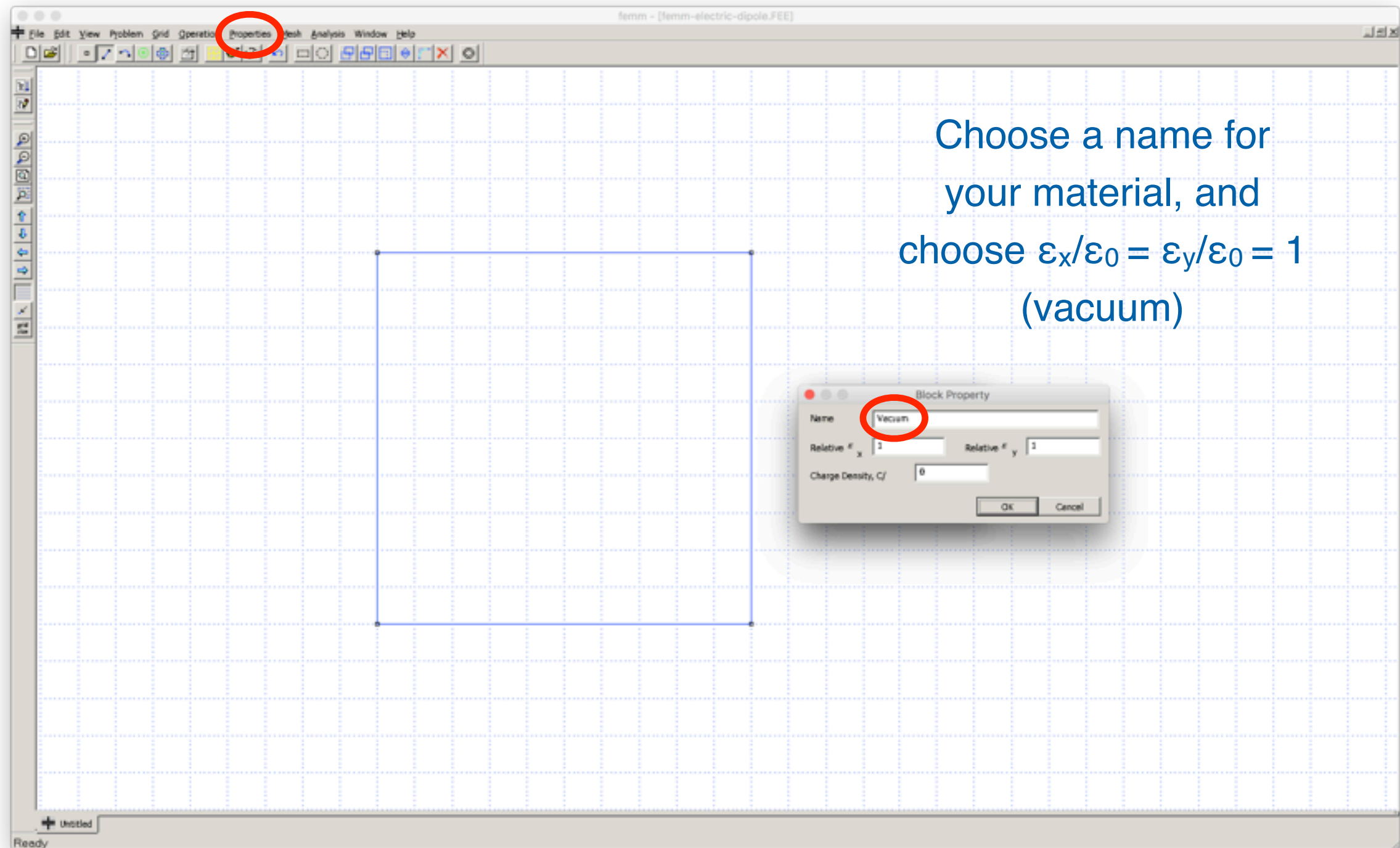

FEMM Tutorial: Electrostatics

- Add material, “Vacuum”

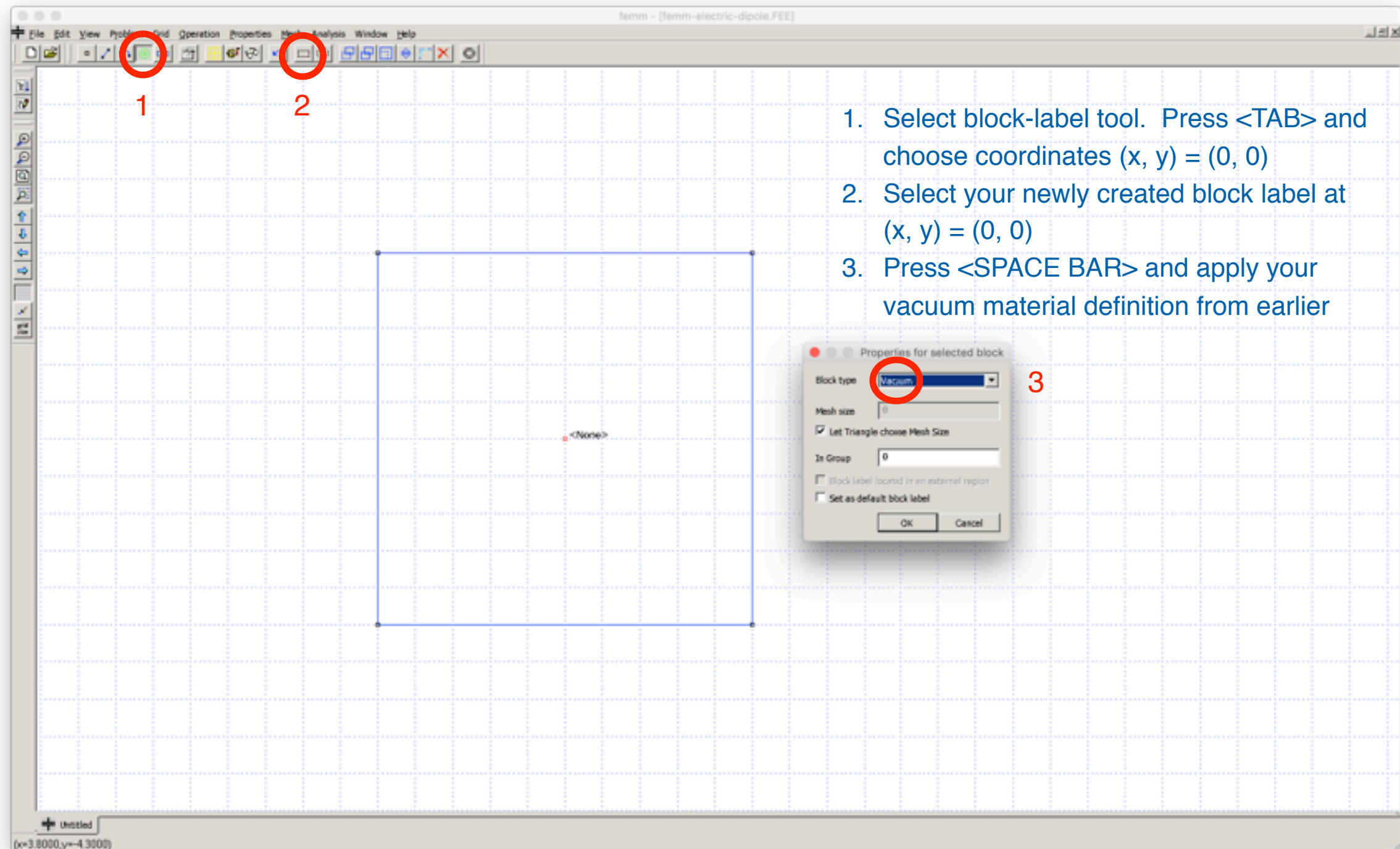

1. Select block-label tool. Press <TAB> and choose coordinates $(x, y) = (0, 0)$
2. Select your newly created block label at $(x, y) = (0, 0)$
3. Press <SPACE BAR> and apply your vacuum material definition from earlier

FEMM Tutorial: Electrostatics

- Create the “outer electrode” by first drawing a line segment

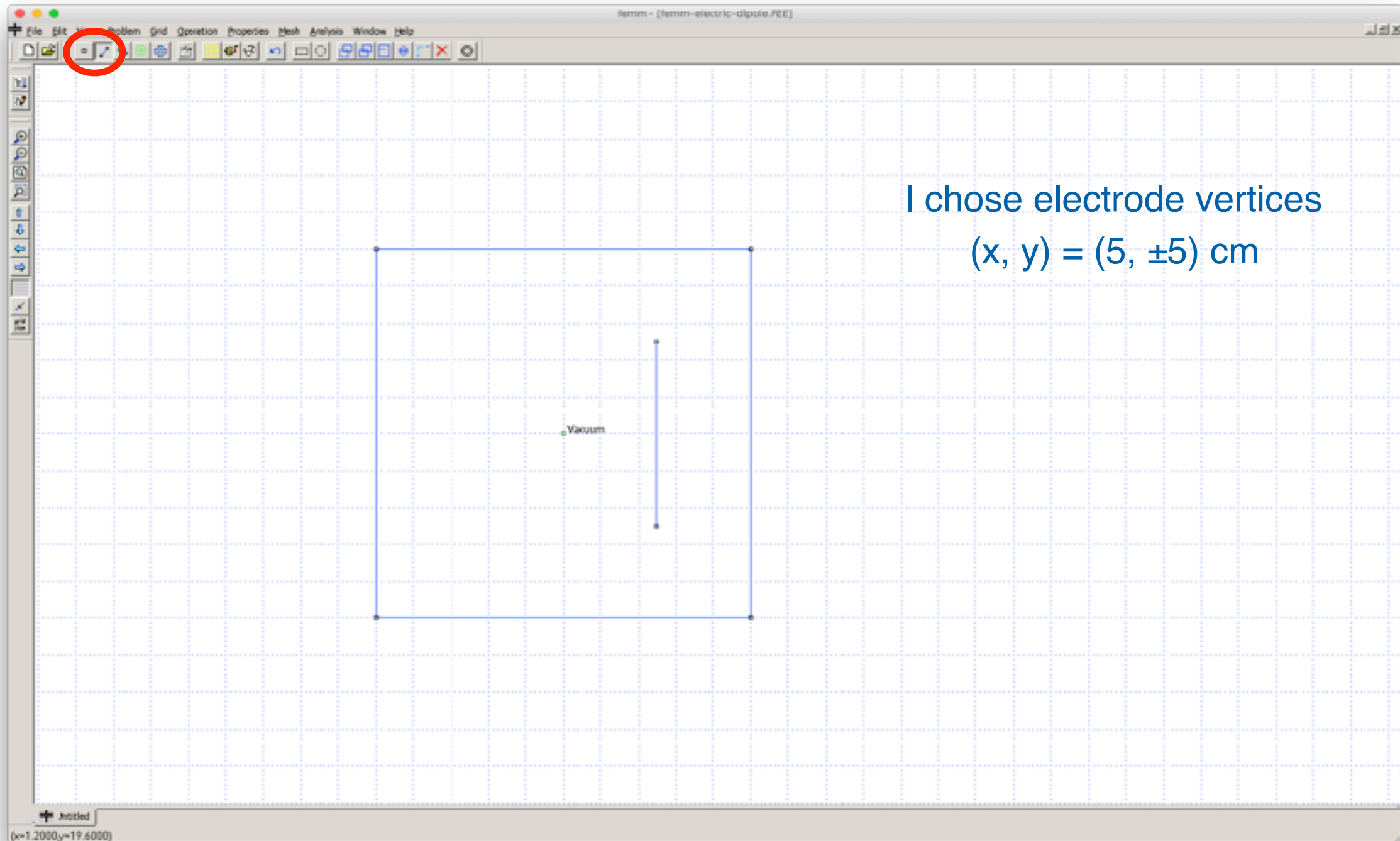

FEMM Tutorial: Electrostatics

- Define the potential for the outer electrode, e.g. +1kV

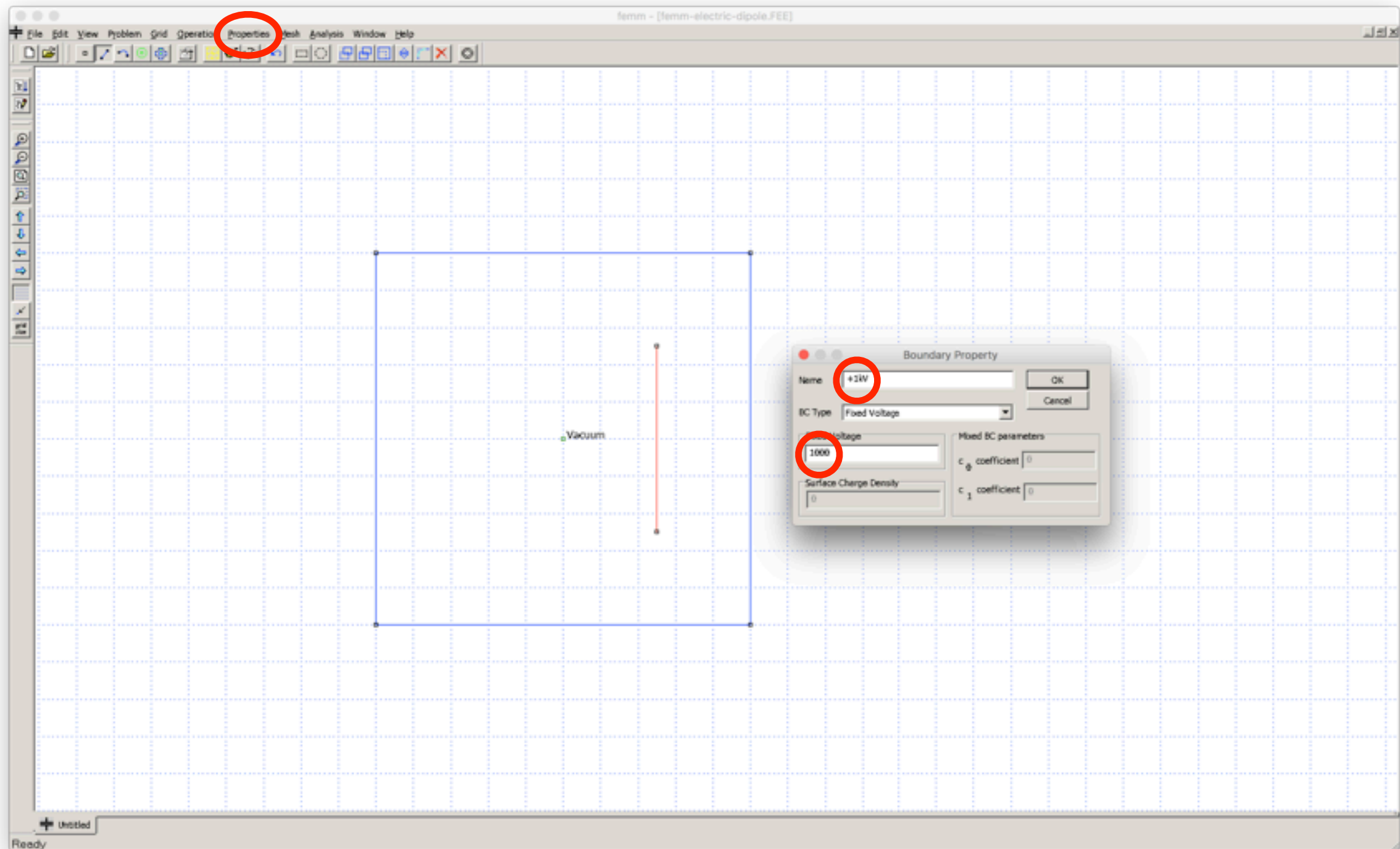

FEMM Tutorial: Electrostatics

- Apply potential to outer electrode, e.g. +1kV

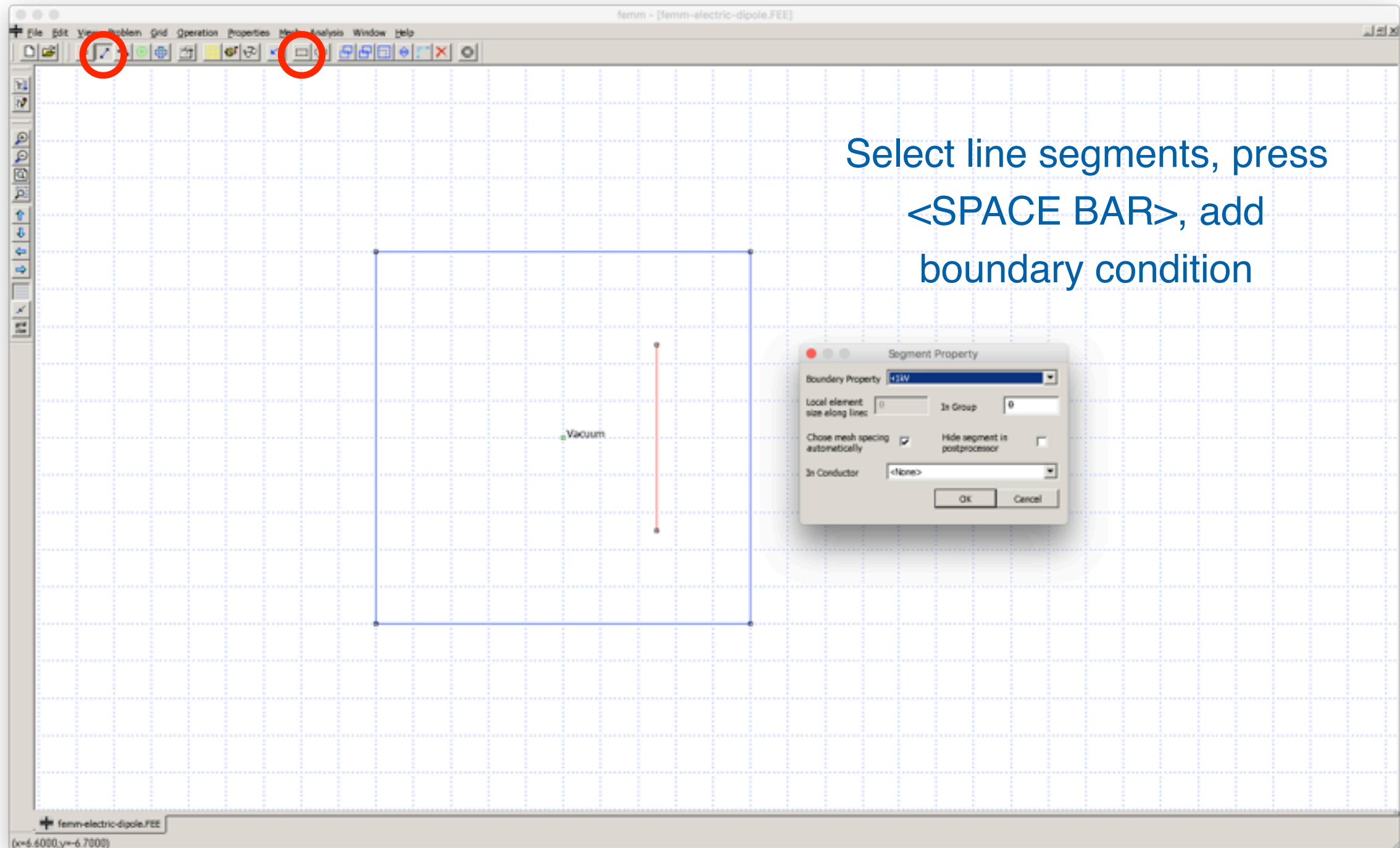

FEMM Tutorial: Electrostatics

- Now create the “inner electrode” by drawing a line, as before

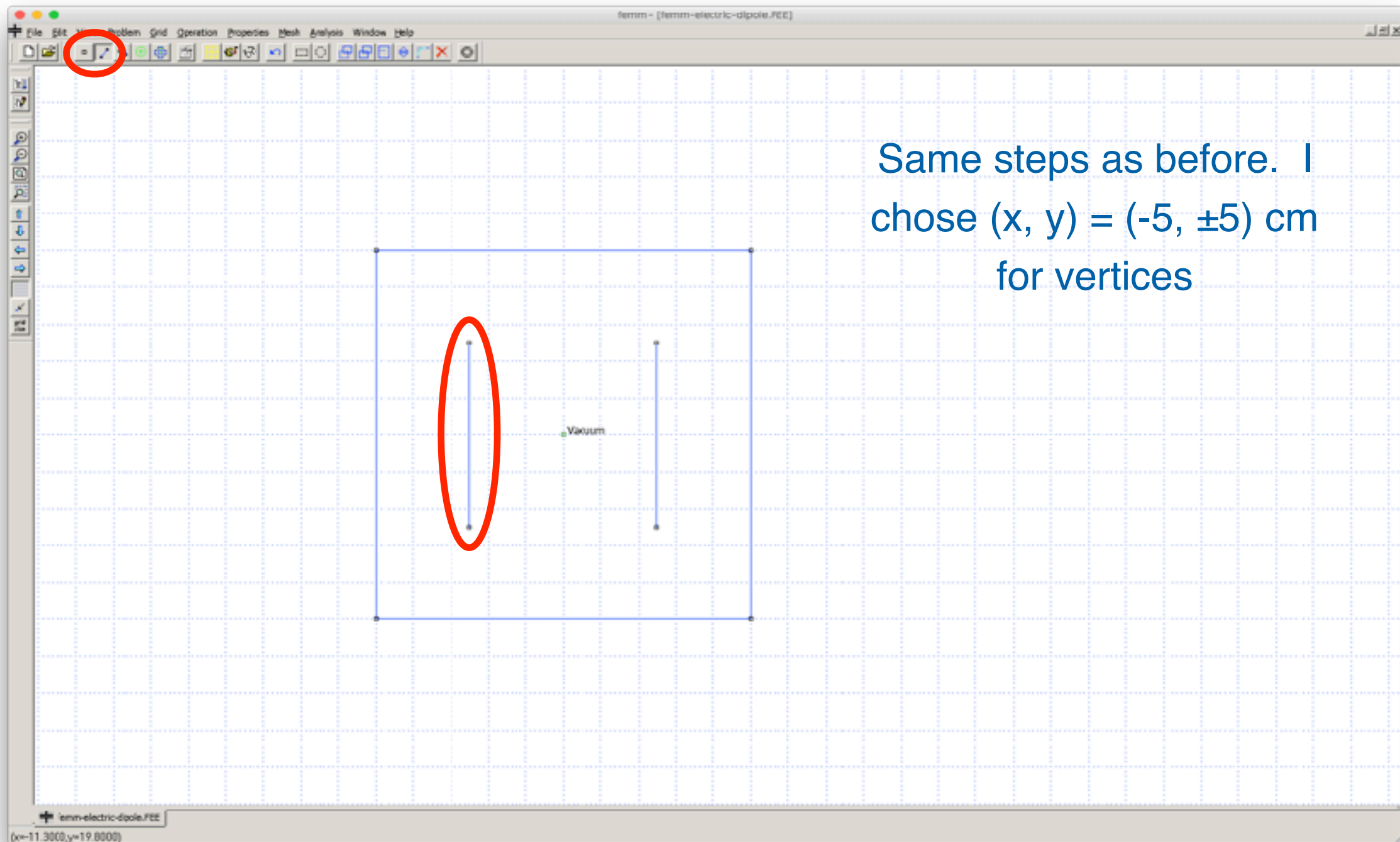

FEMM Tutorial: Electrostatics

- Define the potential for the inner electrode, e.g. -1kV

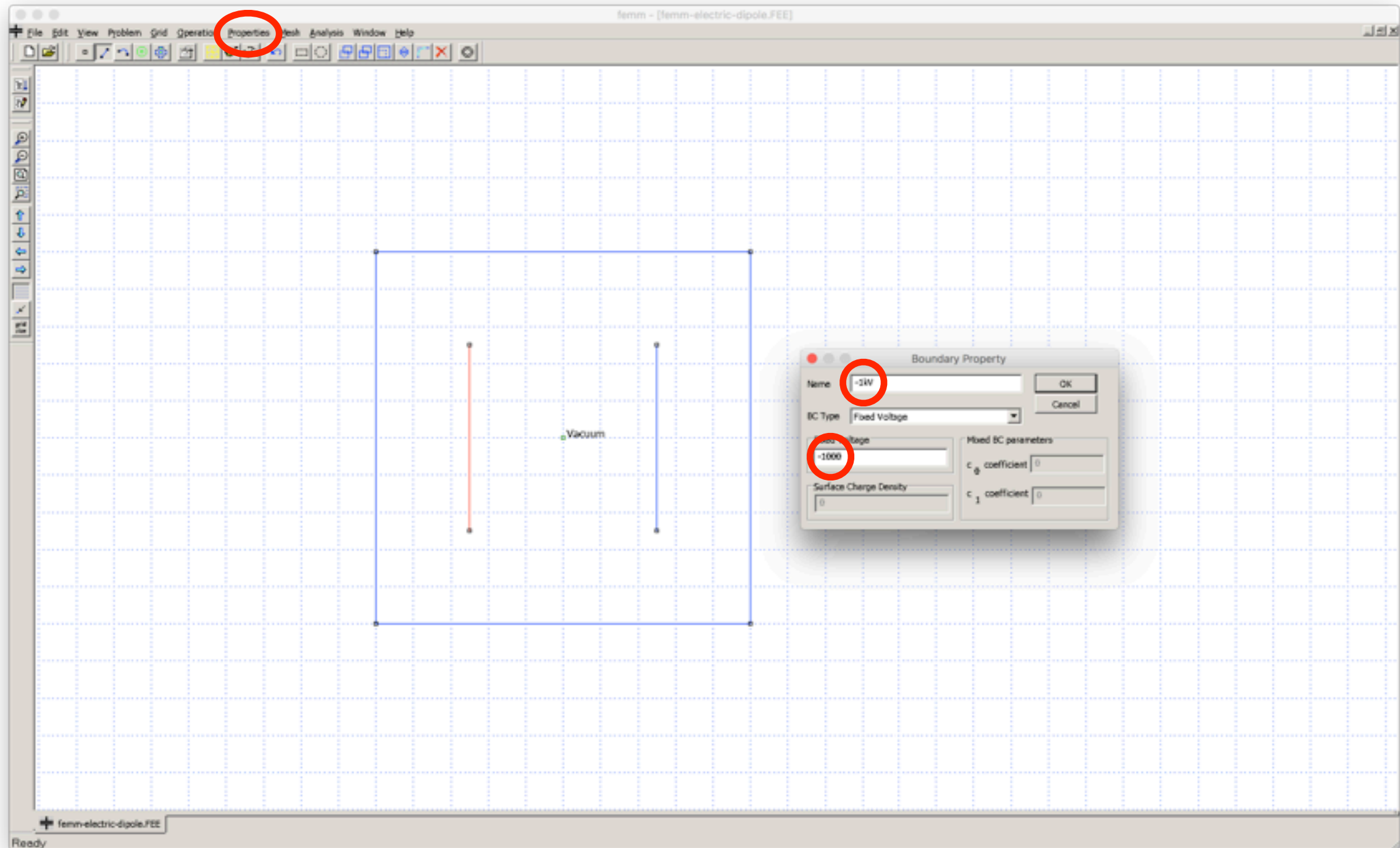

FEMM Tutorial: Electrostatics

- Apply potential to inner electrode, e.g. -1kV

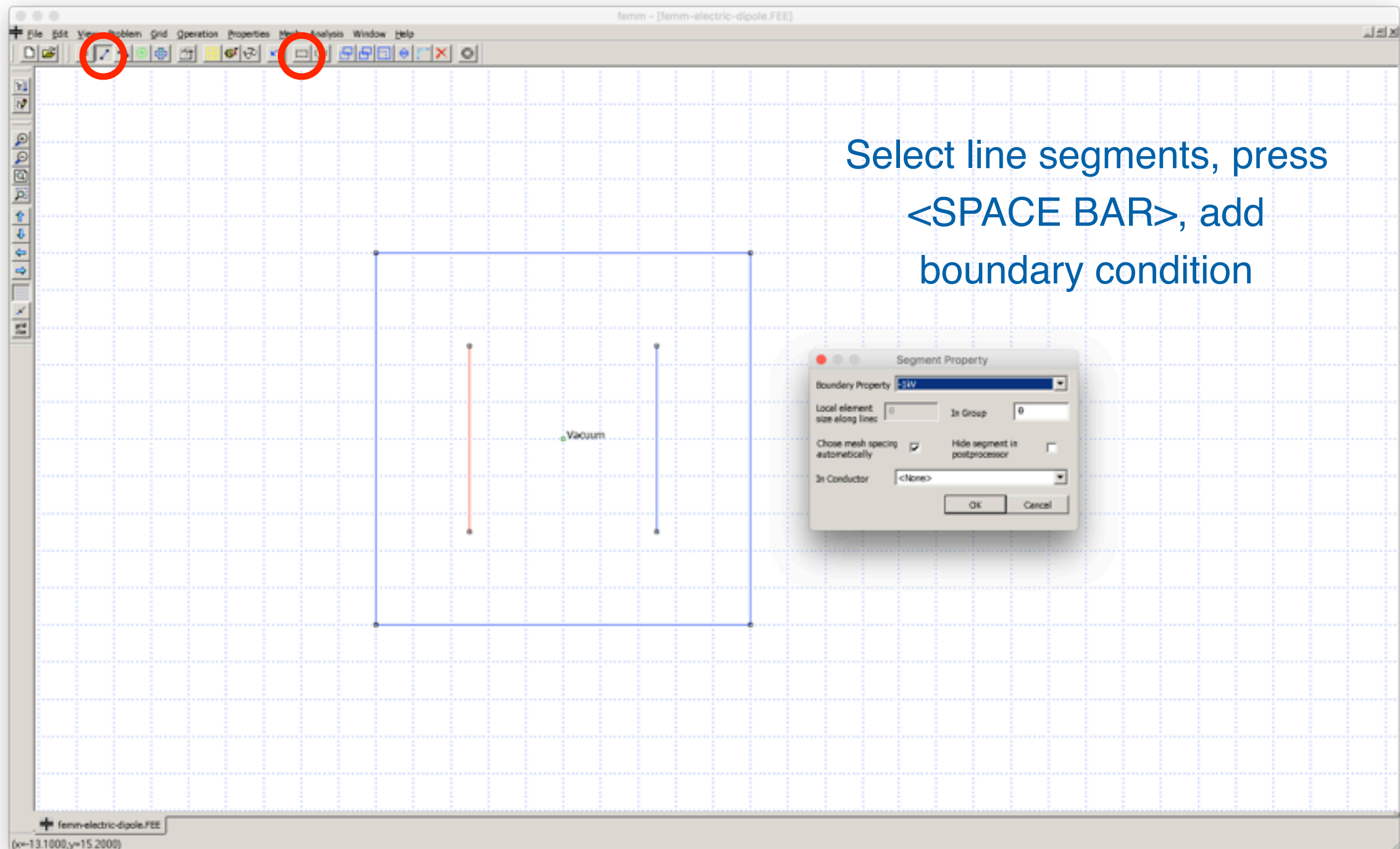

FEMM Tutorial: Electrostatics

- Mesh, analyze, and see the results!

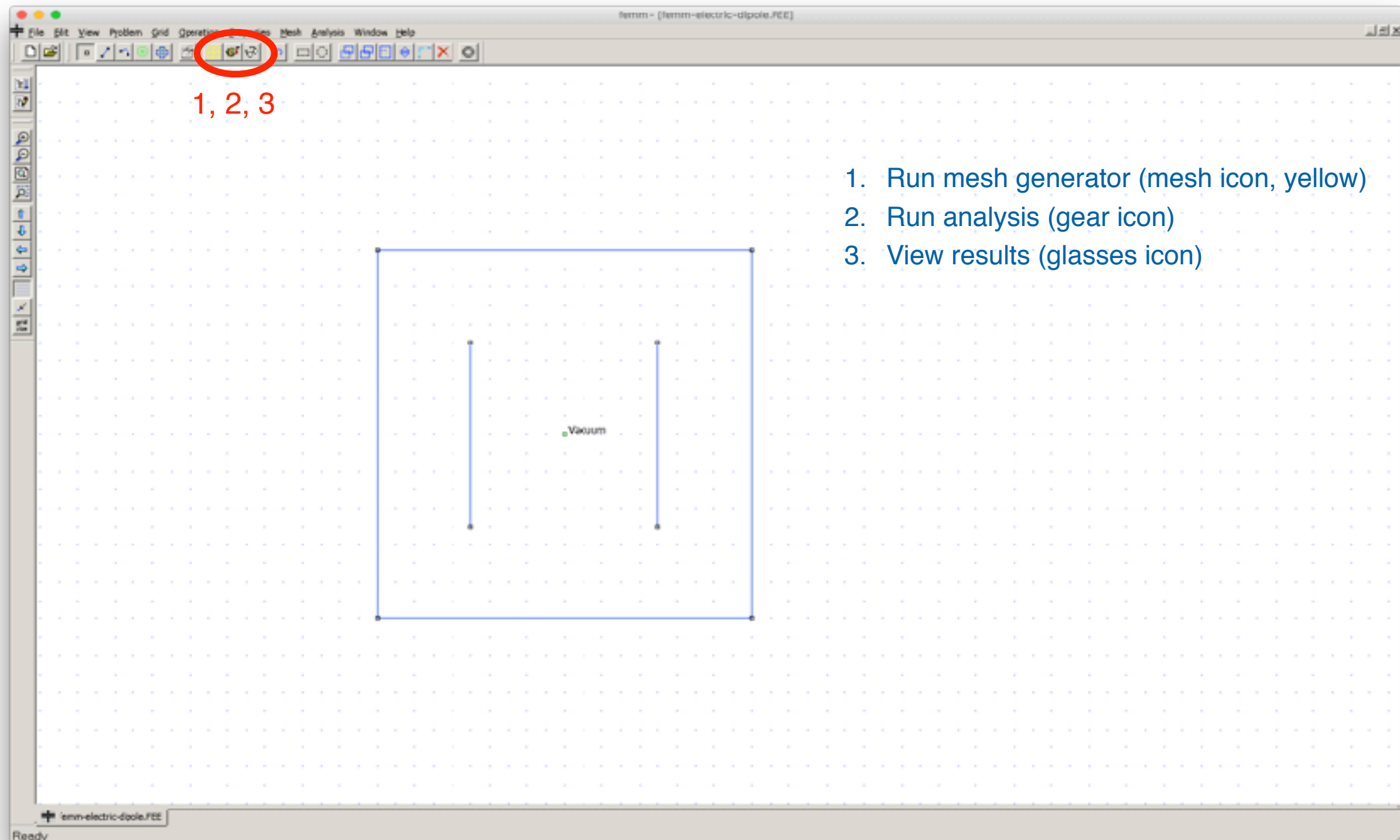

FEMM Tutorial: Electrostatics

- This is what you should see. If not, I can help!

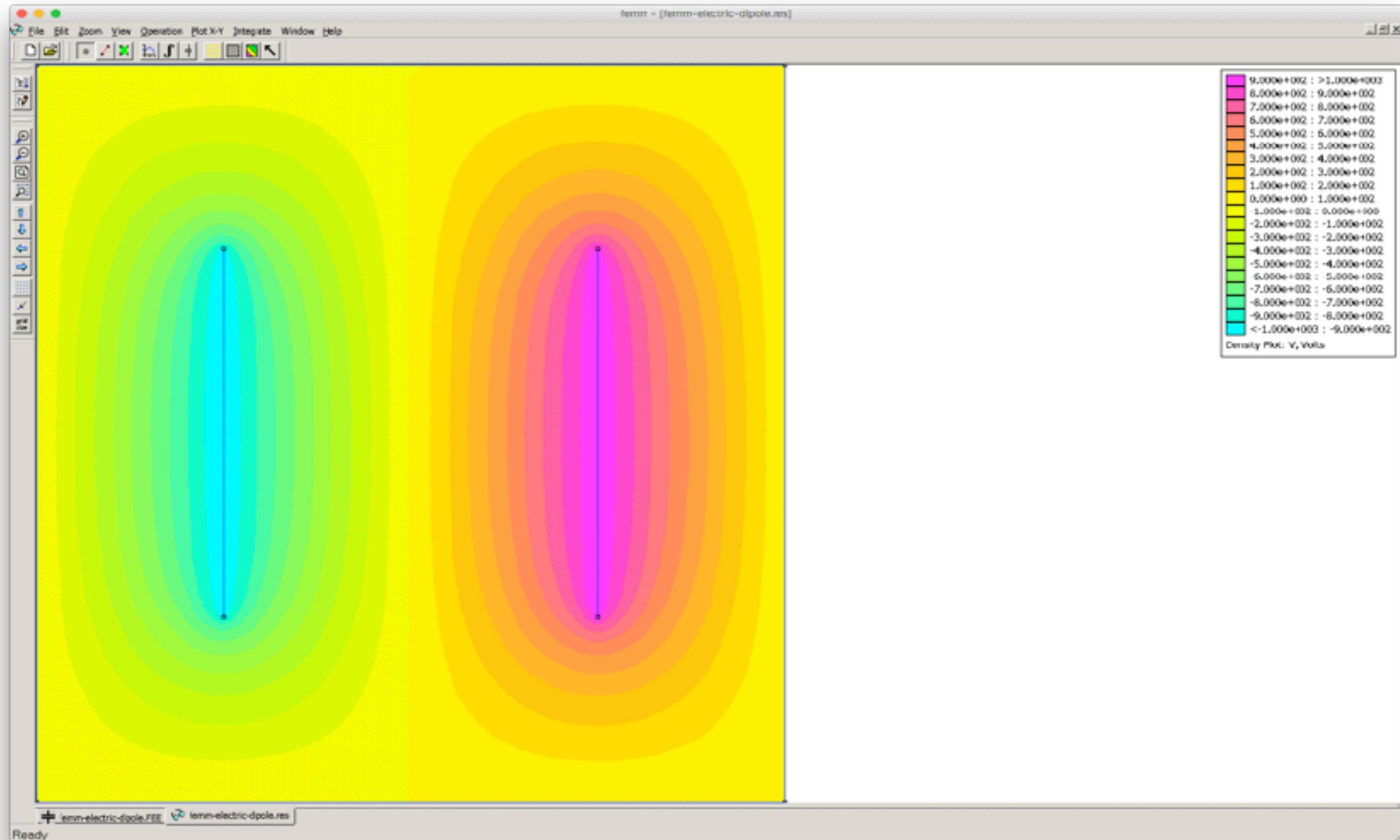

FEMM Tutorial: Electrostatics

- Suppose we want the E-field in the horizontal midplane....

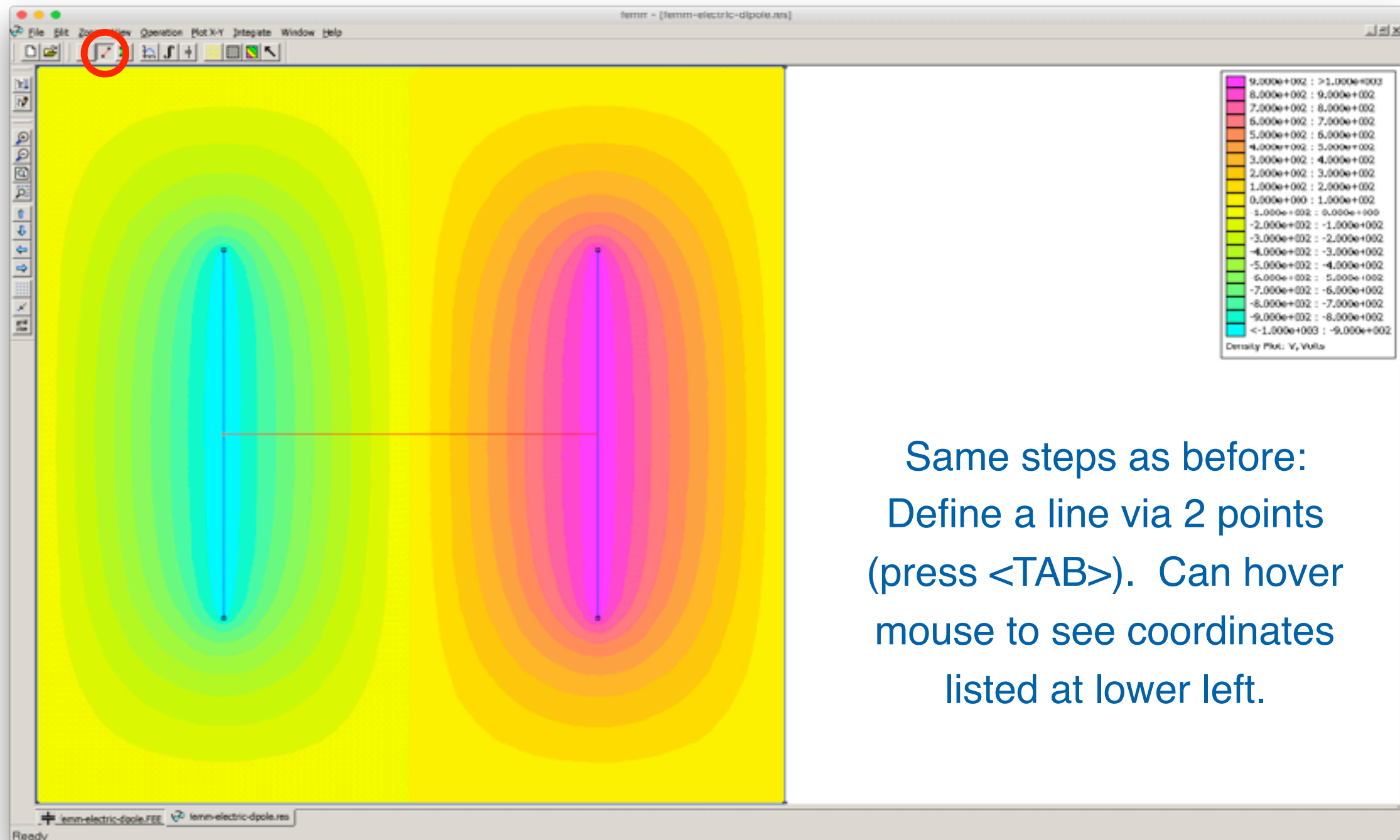

Same steps as before:
Define a line via 2 points
(press <TAB>). Can hover
mouse to see coordinates
listed at lower left.

FEMM Tutorial: Electrostatics

- Now make a plot by clicking the “plot” icon. Can export to text file....

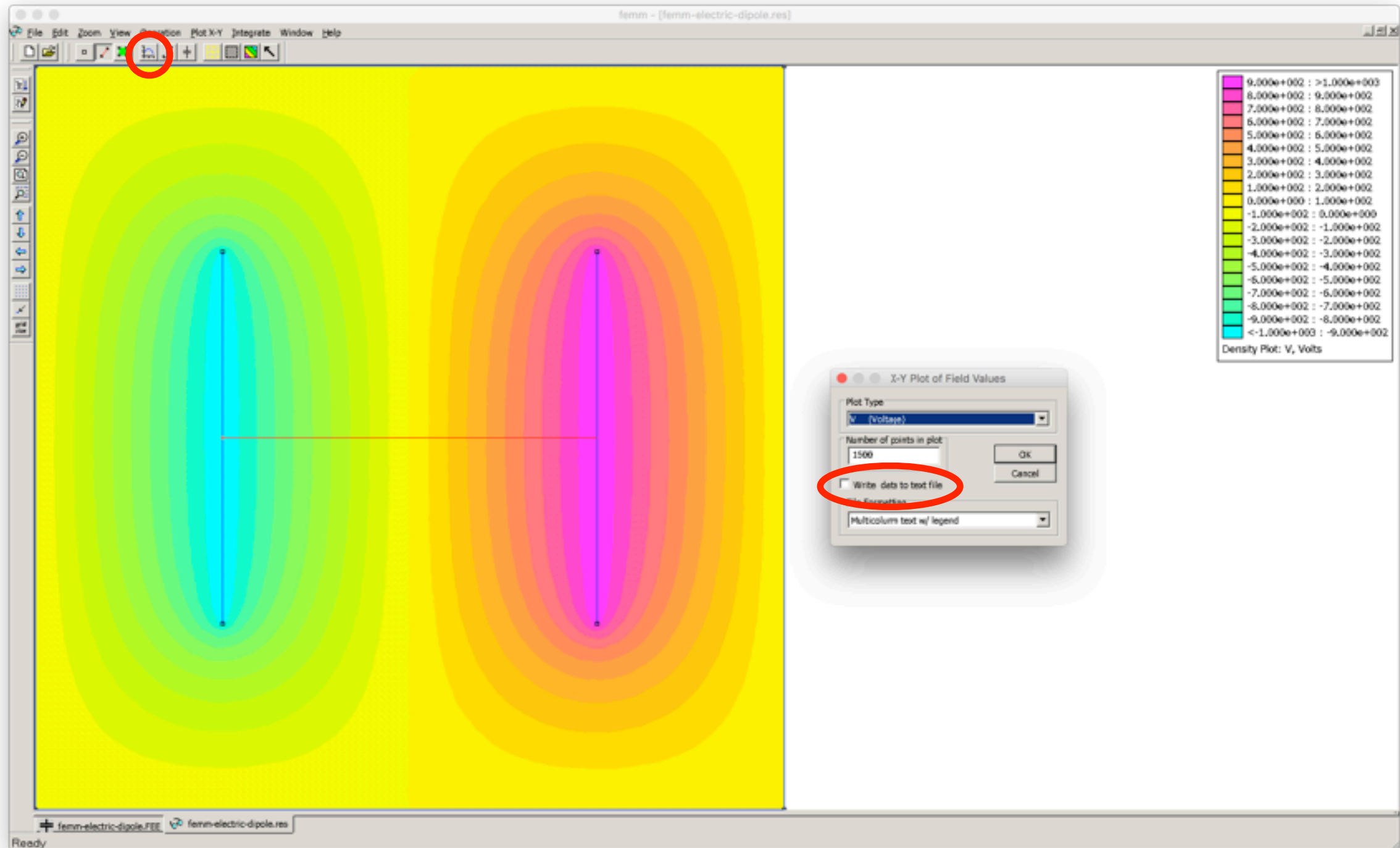

FEMM Tutorial: Electrostatics

- Our first results! (Does the plot make sense?)

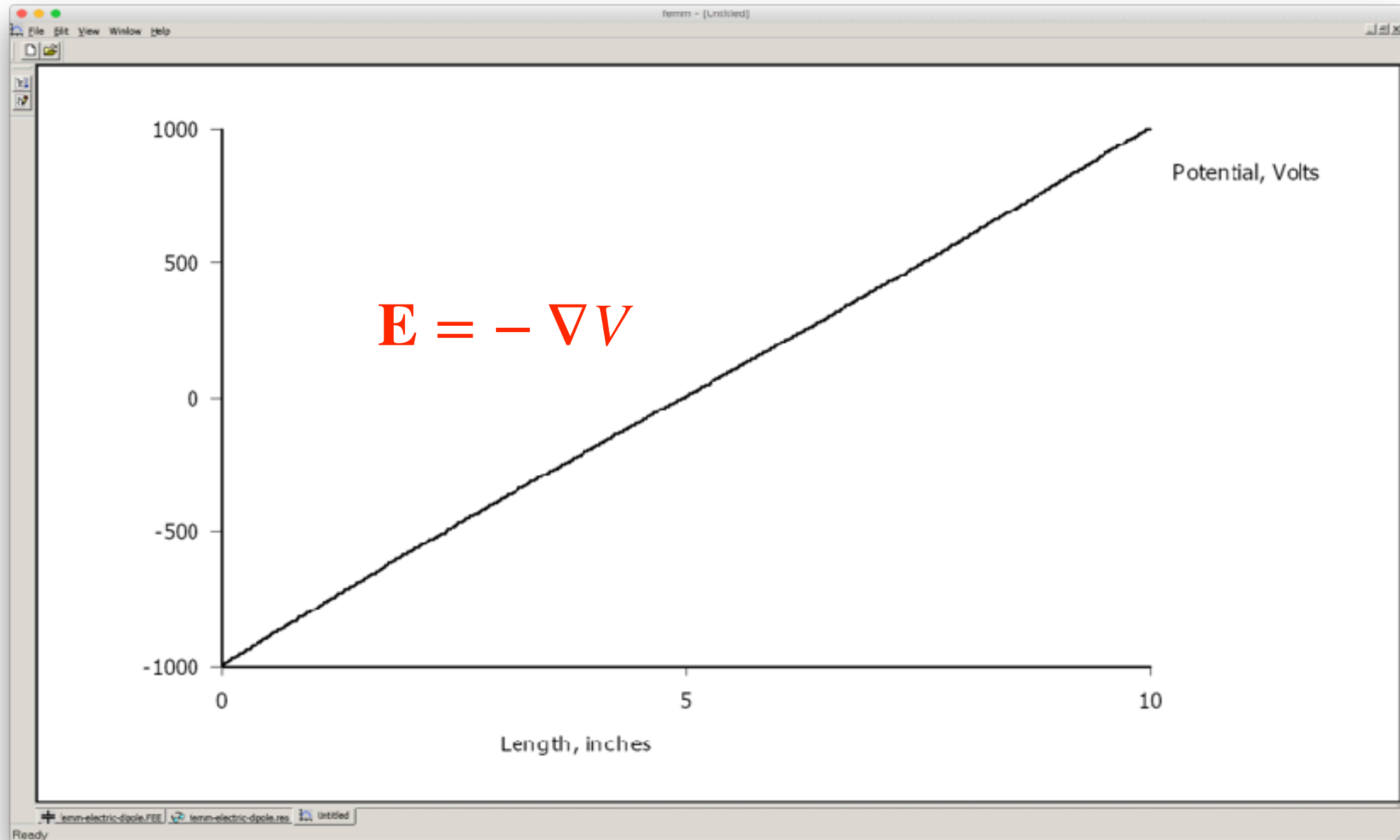

FEMM Tutorial: Electrostatics

- Now we'll modify the dipole to make a quadrupole. Always save your work!

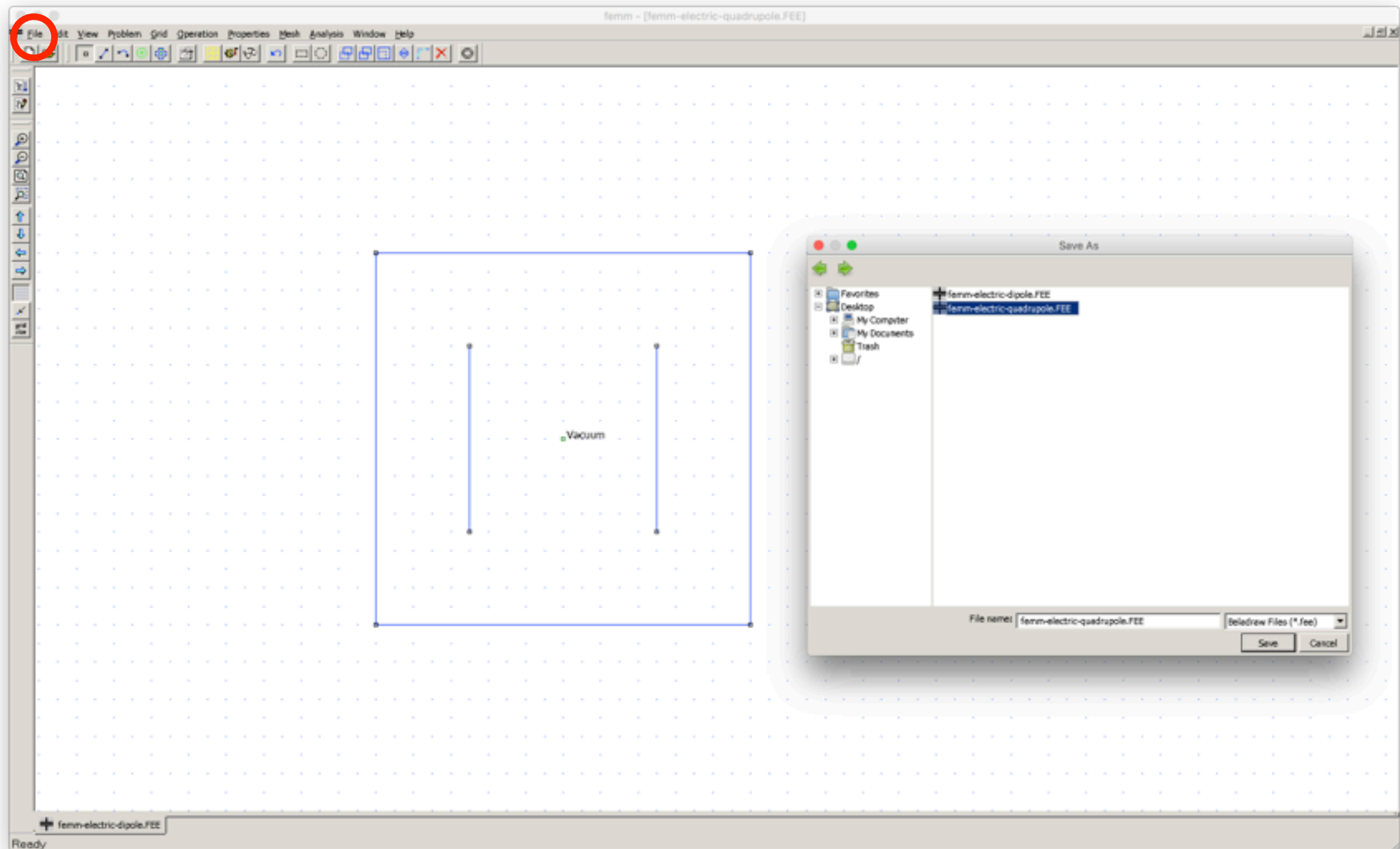

FEMM Tutorial: Electrostatics

- Add another couple of electrodes to make quadrupole

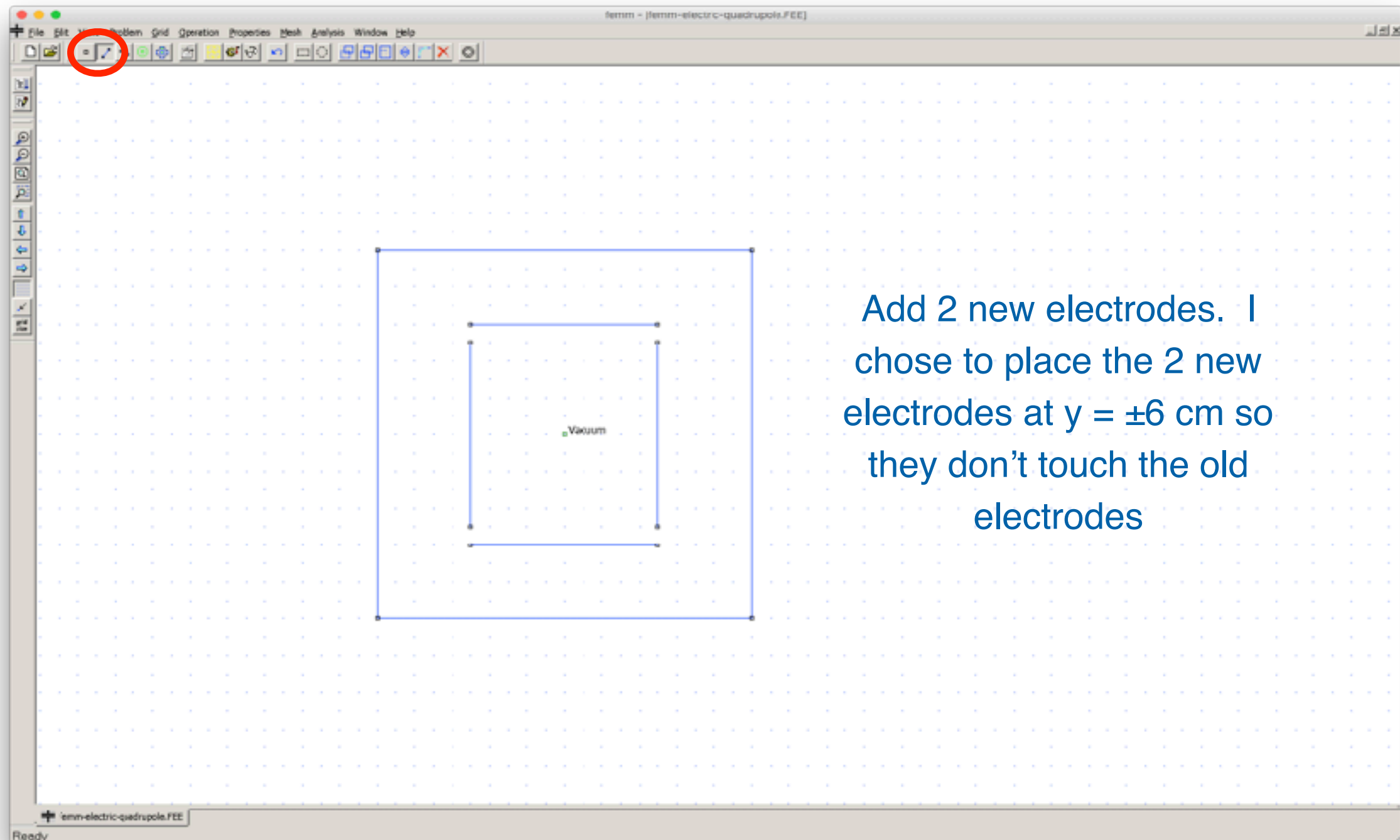

Add 2 new electrodes. I chose to place the 2 new electrodes at $y = \pm 6$ cm so they don't touch the old electrodes

FEMM Tutorial: Electrostatics

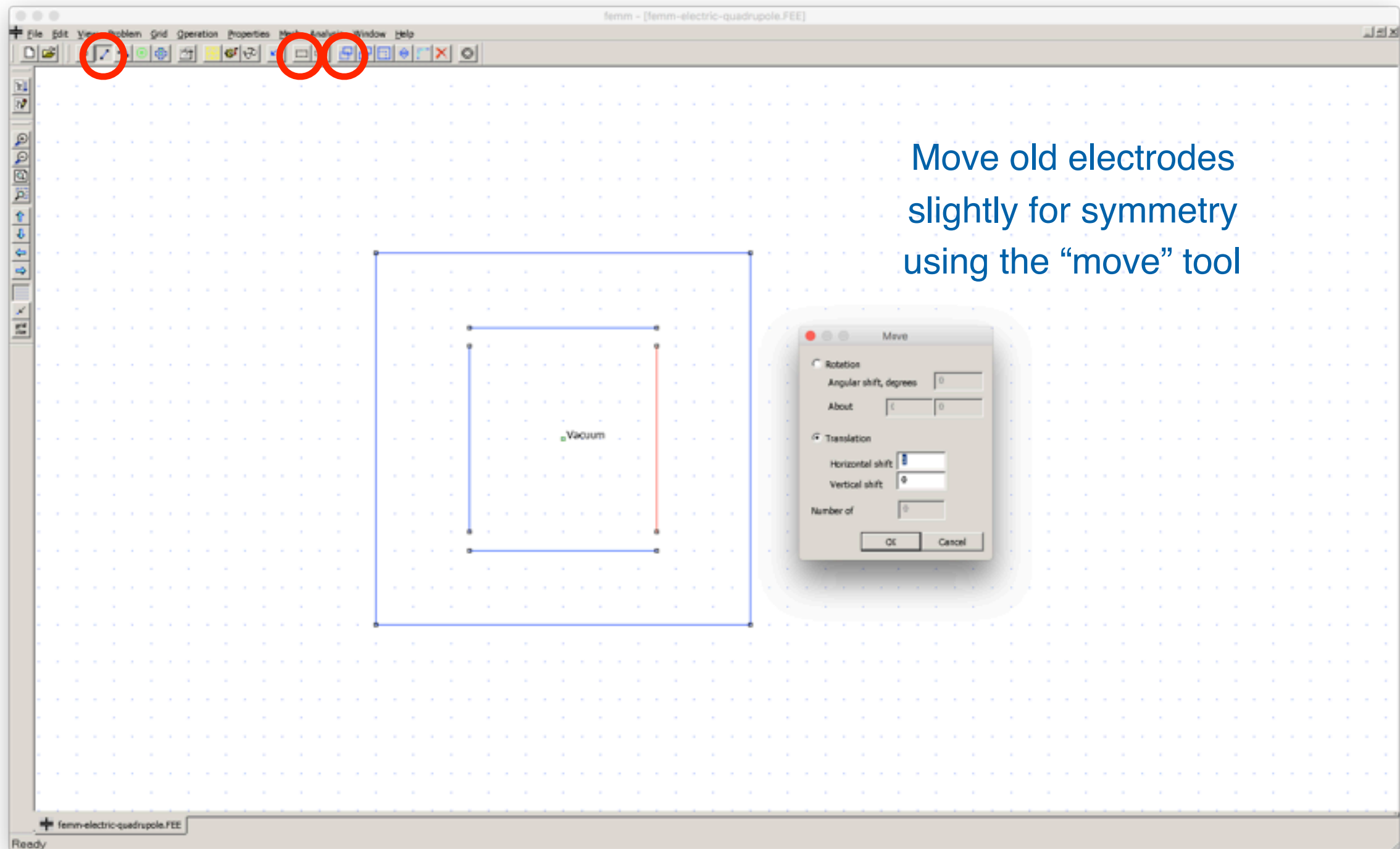

FEMM Tutorial: Electrostatics

- Set electrode voltages for vertical focusing of positively-charged particles

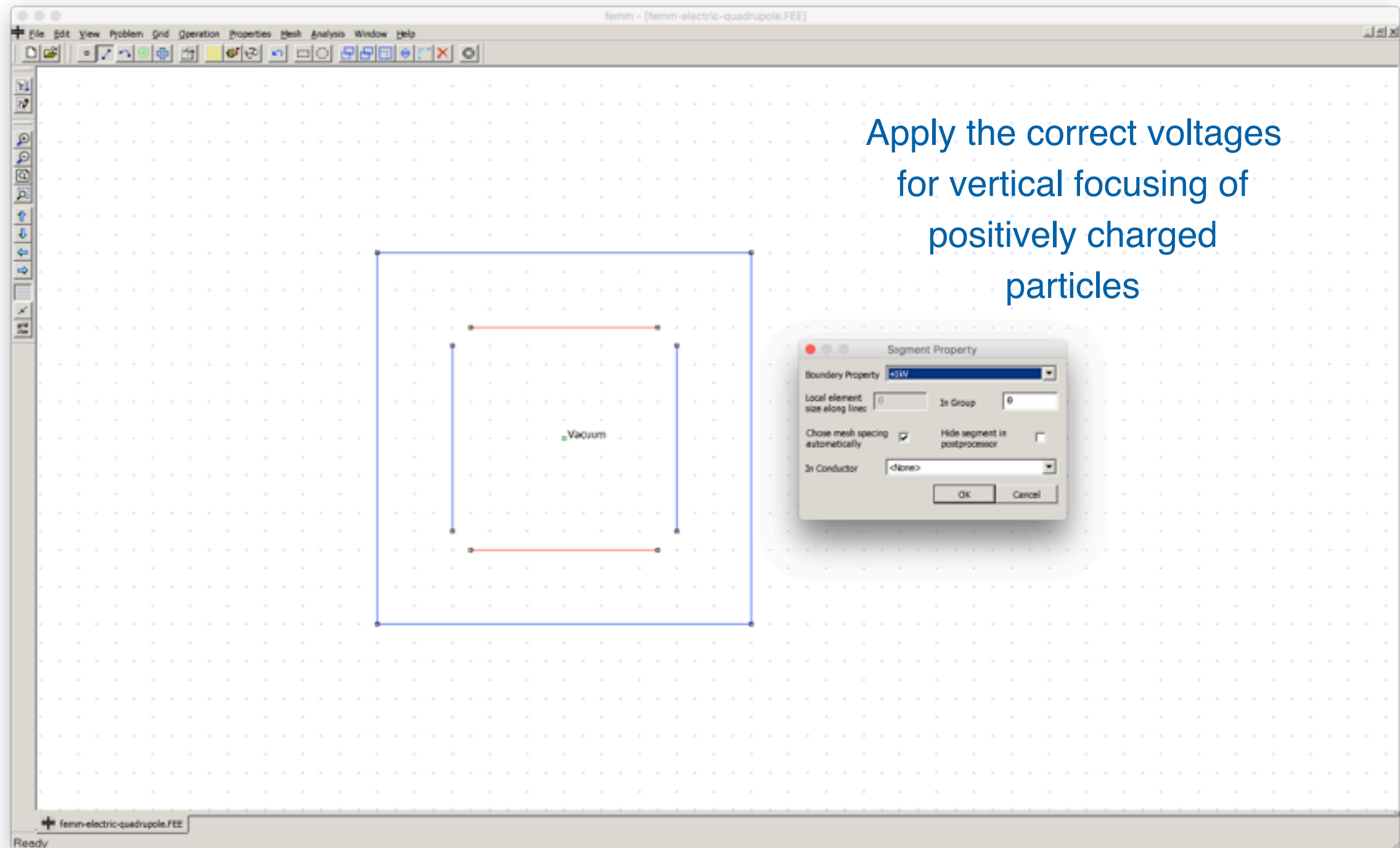

FEMM Tutorial: Electrostatics

- This is what your solution should look like. If not, I can help!

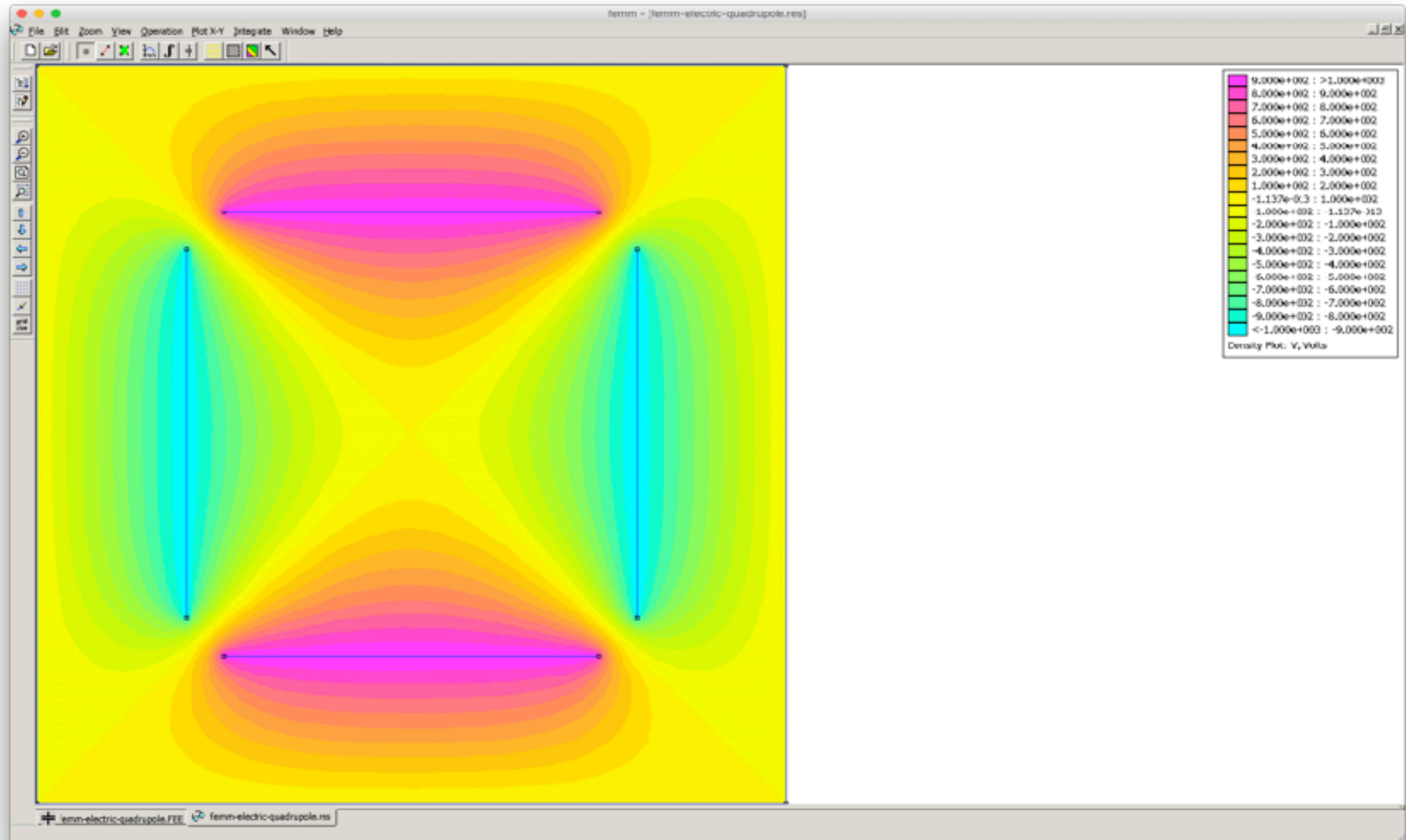

FEMM Tutorial: Electrostatics

- Plot the potential in the horizontal midplane. (Does it make sense?)

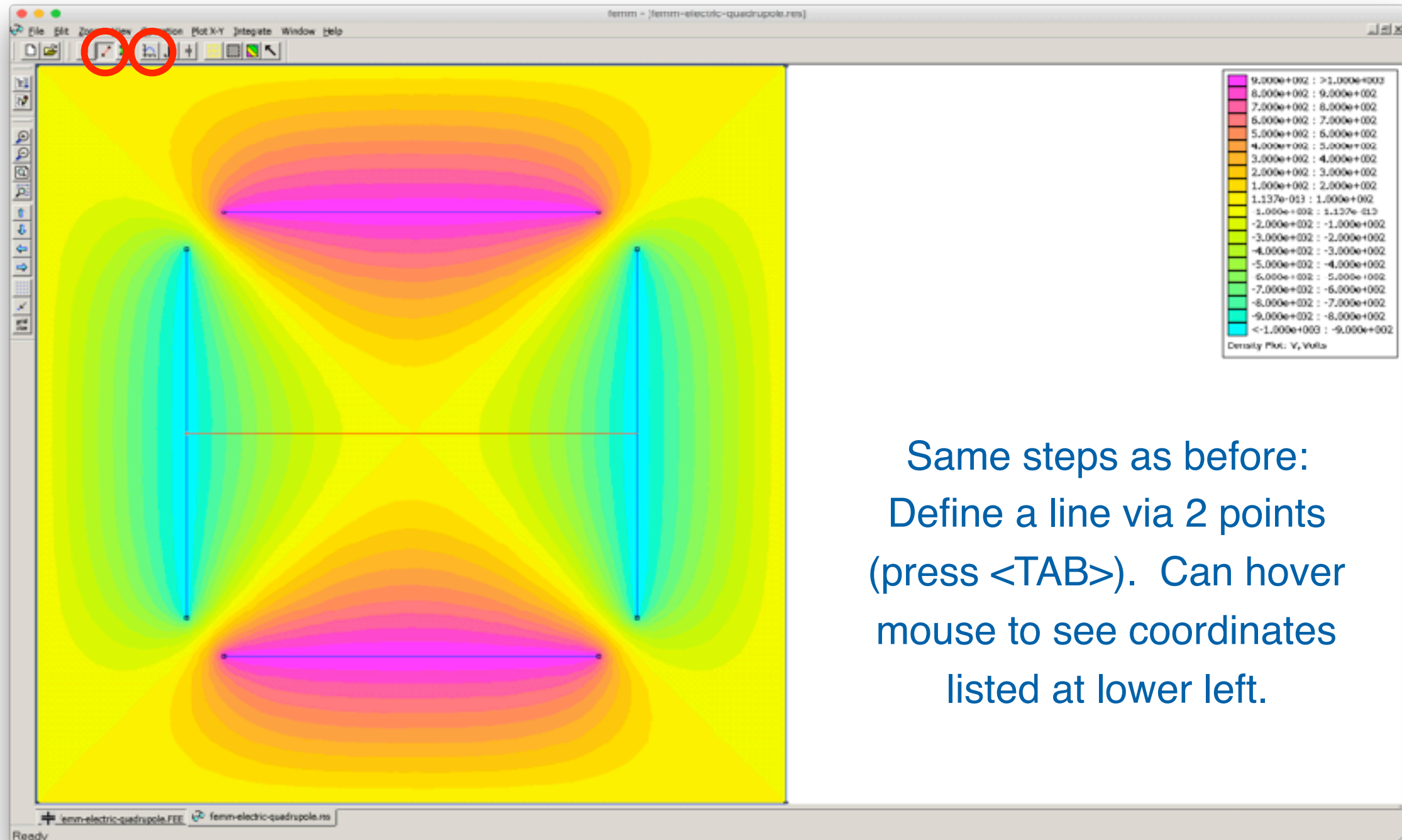

FEMM Tutorial: Electrostatics

- Plot the potential in the horizontal midplane. (Does it make sense?)

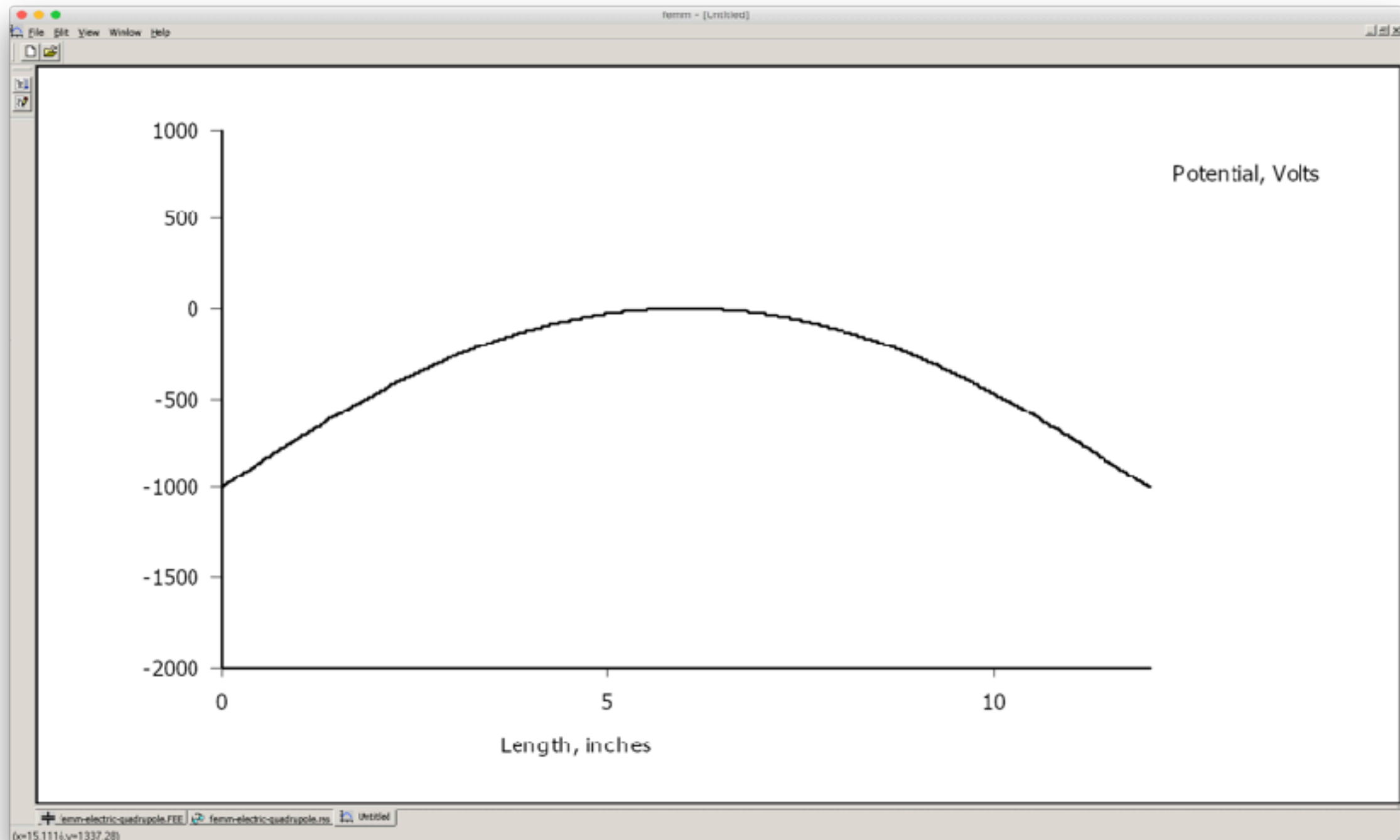

FEMM Tutorial: Electrostatics

- What about a curved longitudinal axis, i.e. cylindrical symmetry?

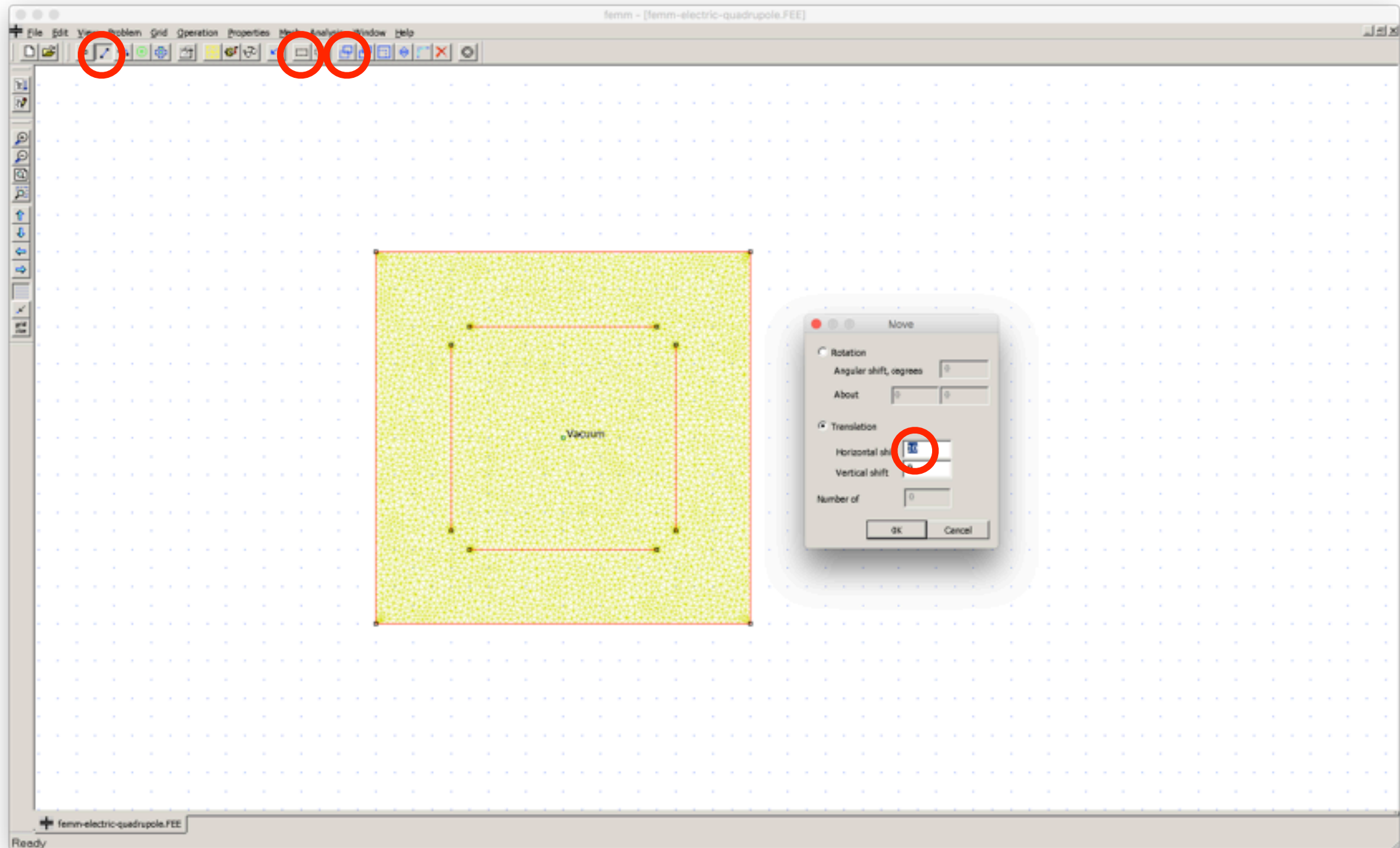

FEMM Tutorial: Electrostatics

- What about a curved longitudinal axis, i.e. cylindrical symmetry?

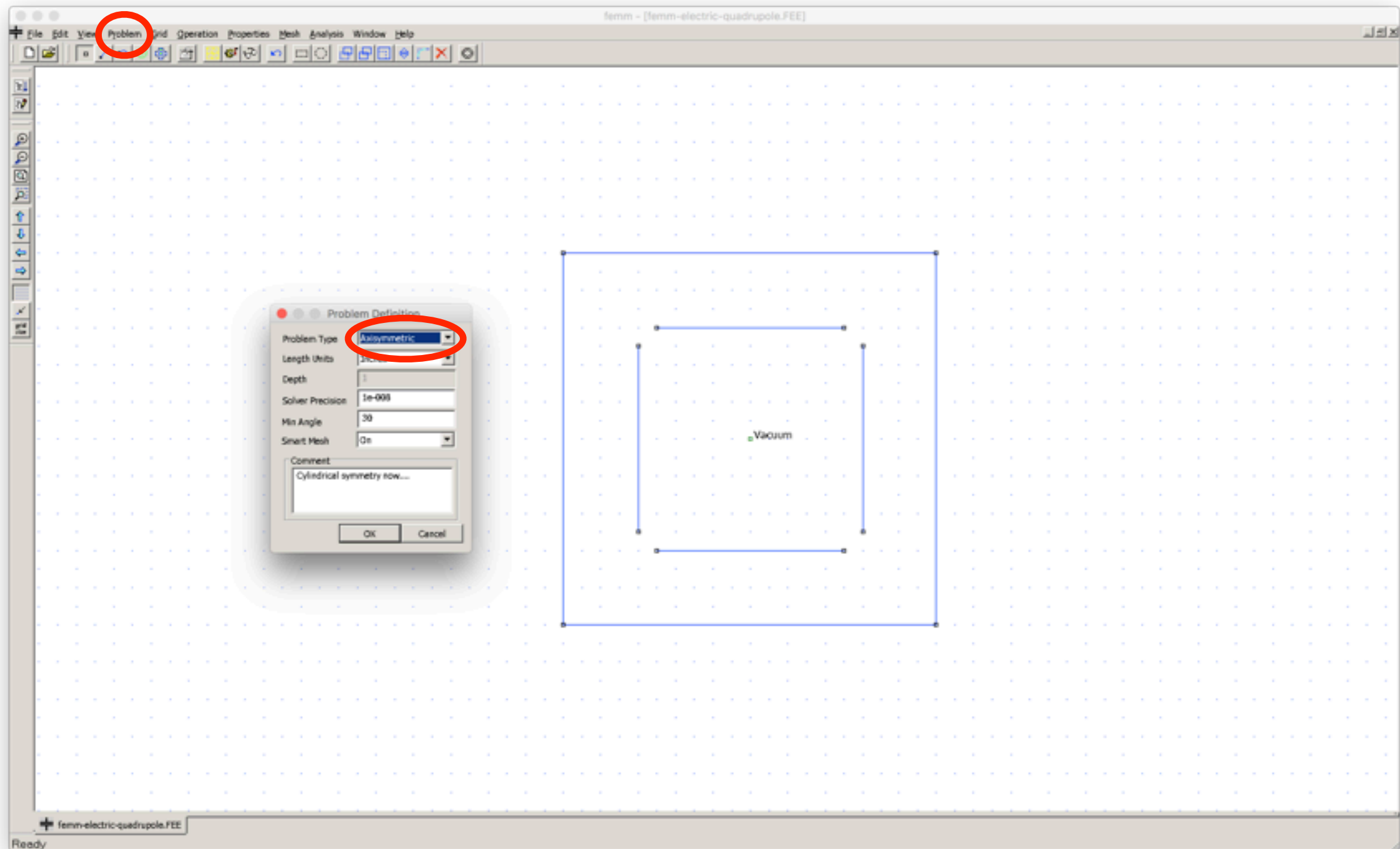

FEMM Tutorial: Electrostatics

- Does the new solution (with cylindrical symmetry) look any different?

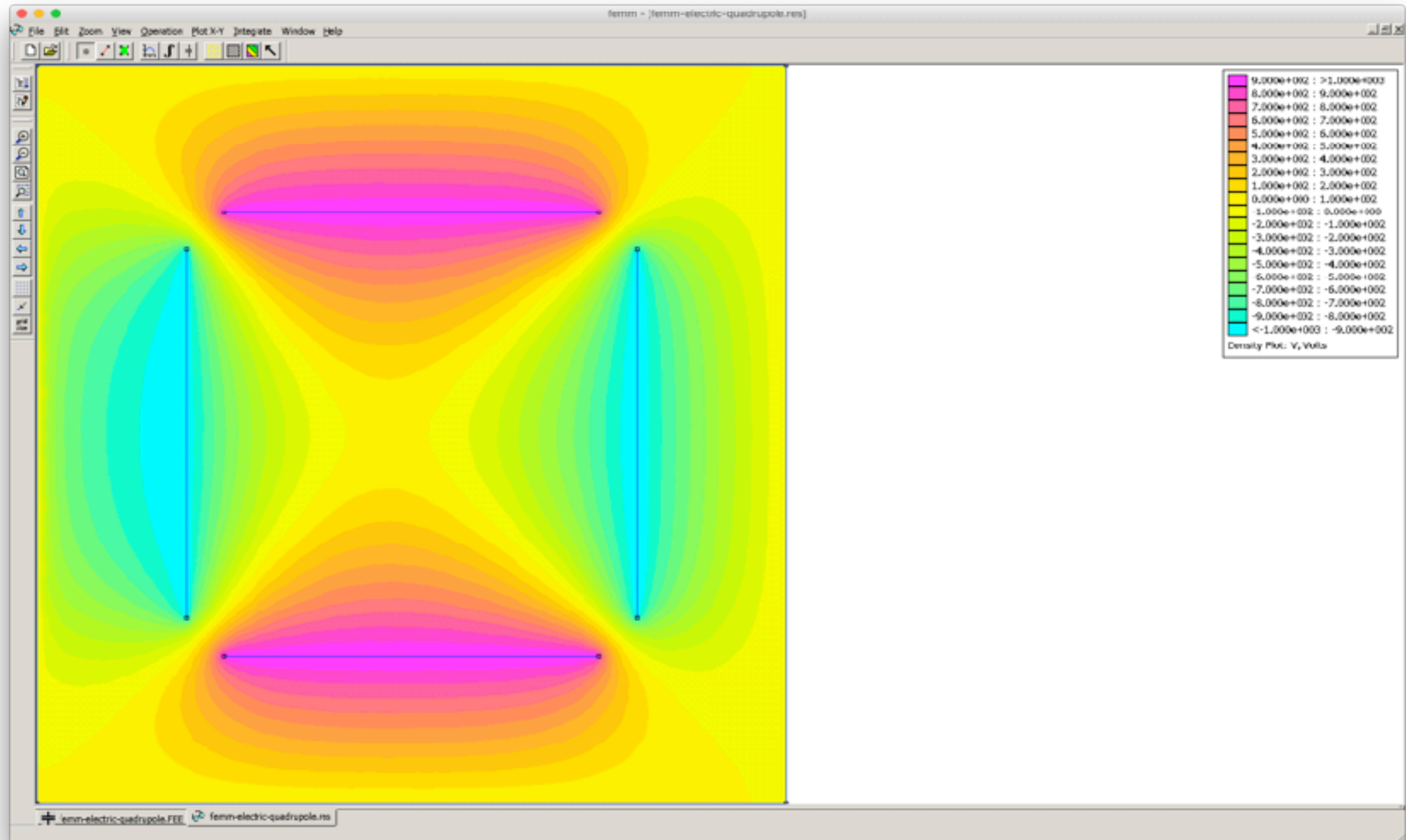

FEMM Tutorial: Electrostatics

- Plot the potential in the horizontal midplane

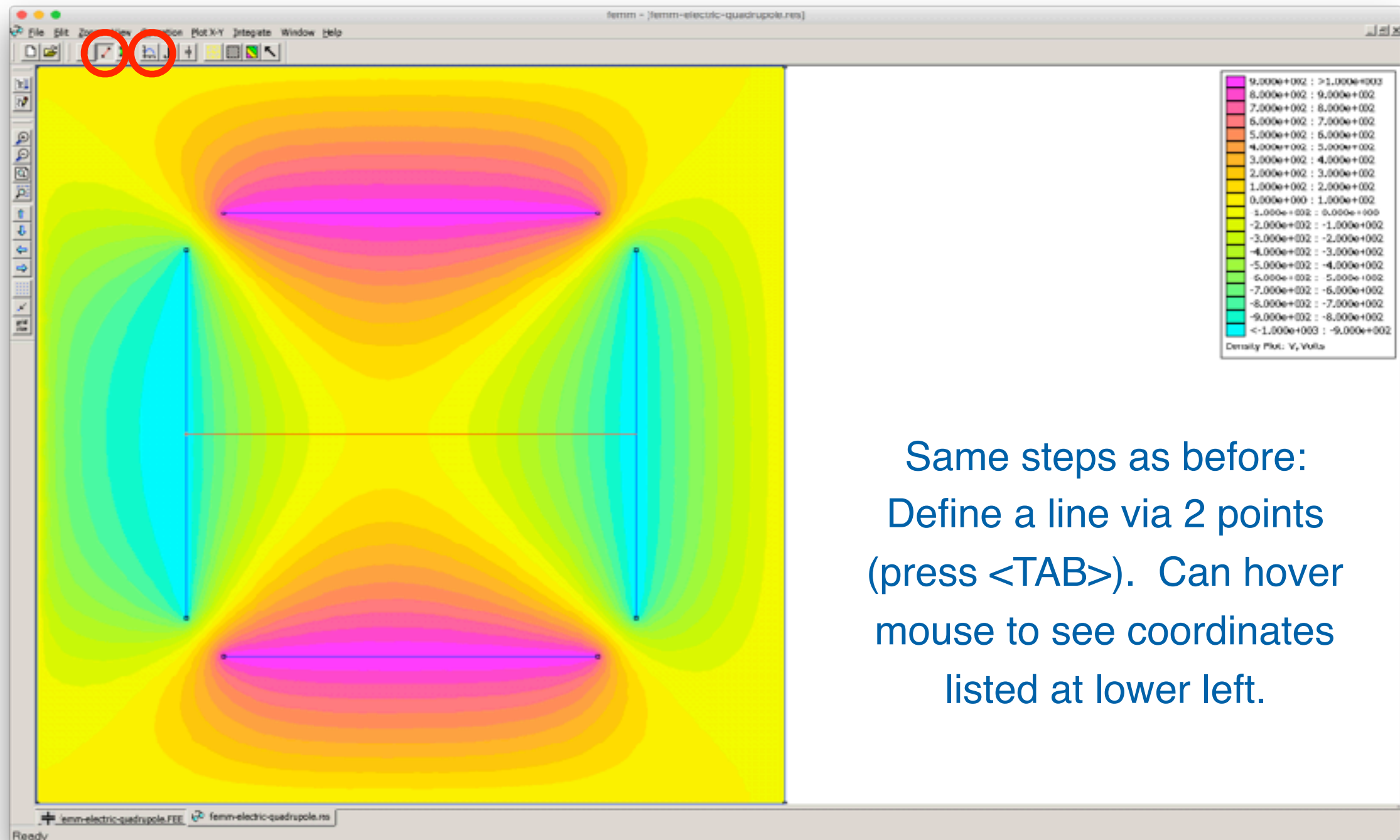

Same steps as before:
Define a line via 2 points
(press <TAB>). Can hover
mouse to see coordinates
listed at lower left.

FEMM Tutorial: Electrostatics

- Plot the potential in the horizontal midplane

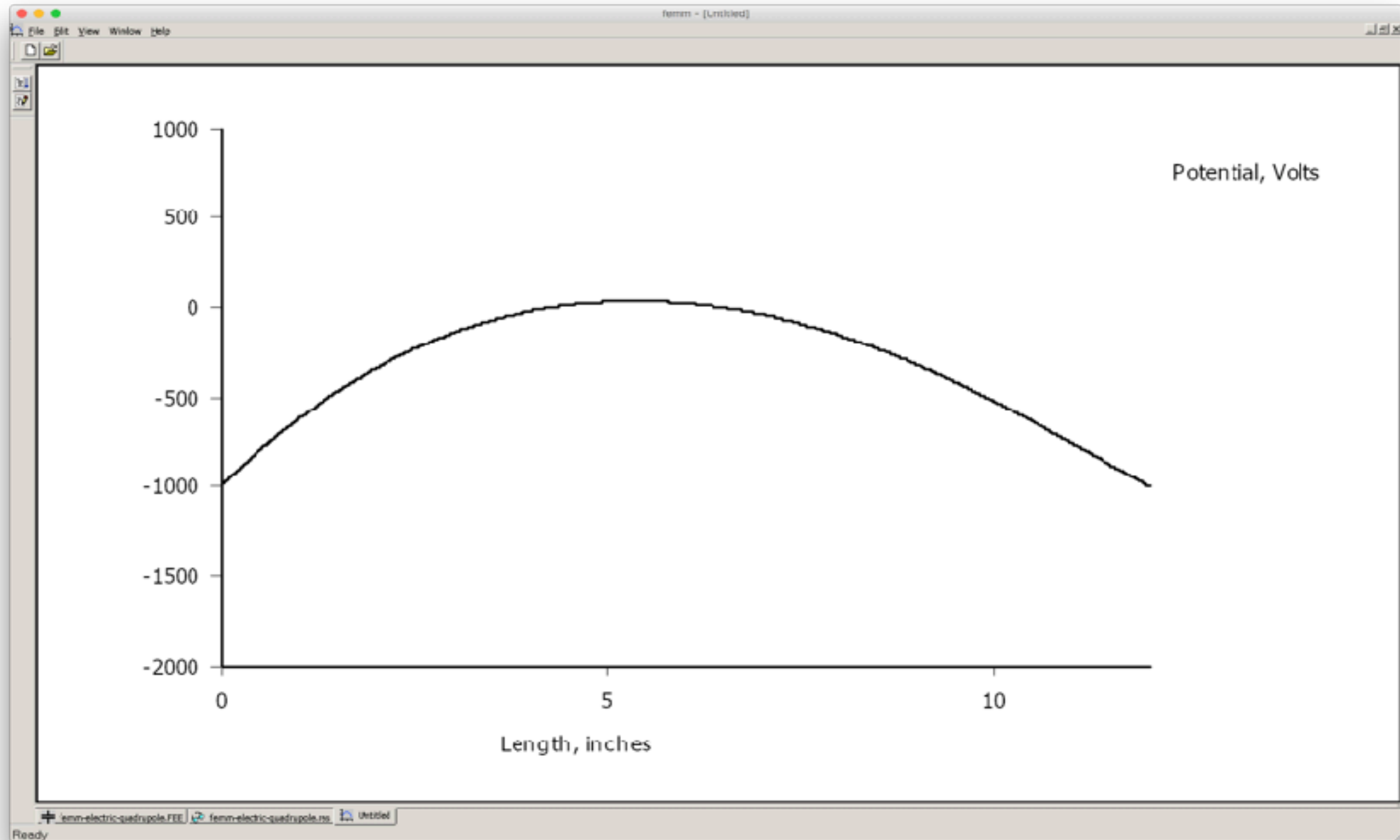

FEMM Tutorial: Electrostatics

- Compare the two cases, i.e. Cartesian vs. Cylindrical coordinates

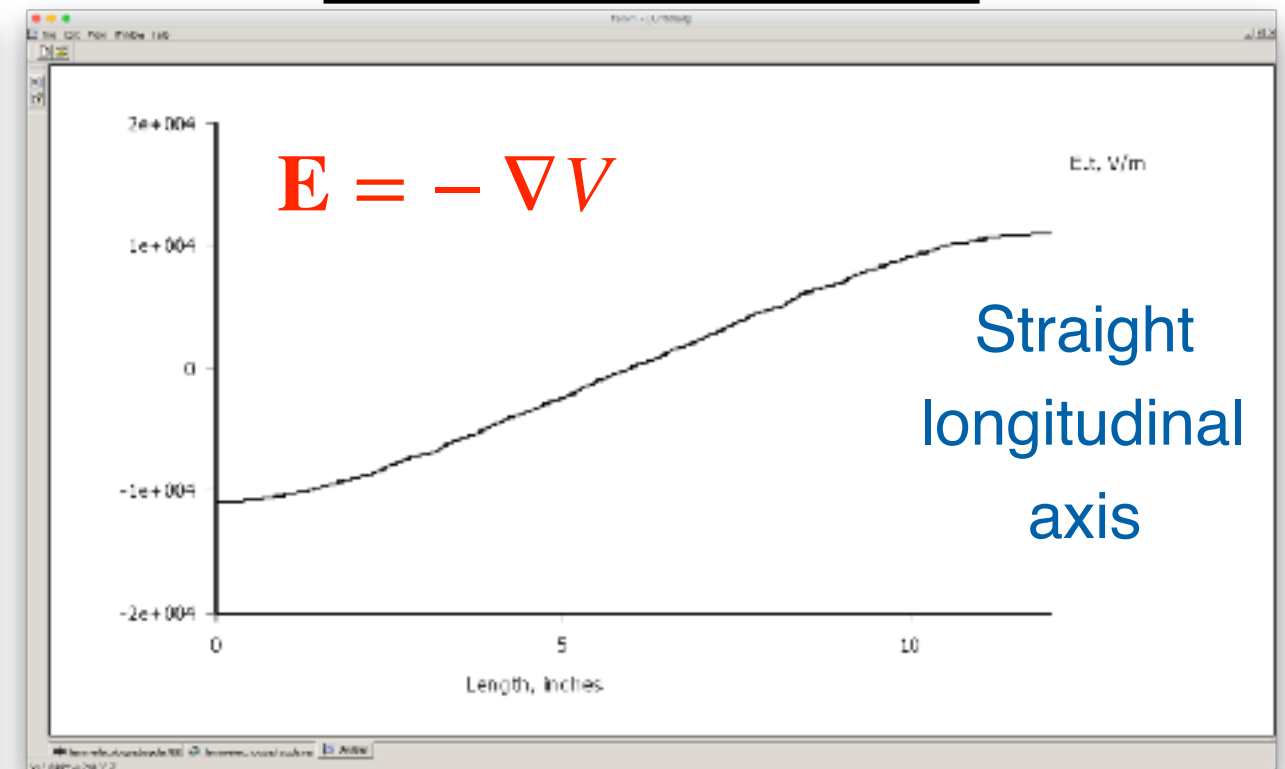
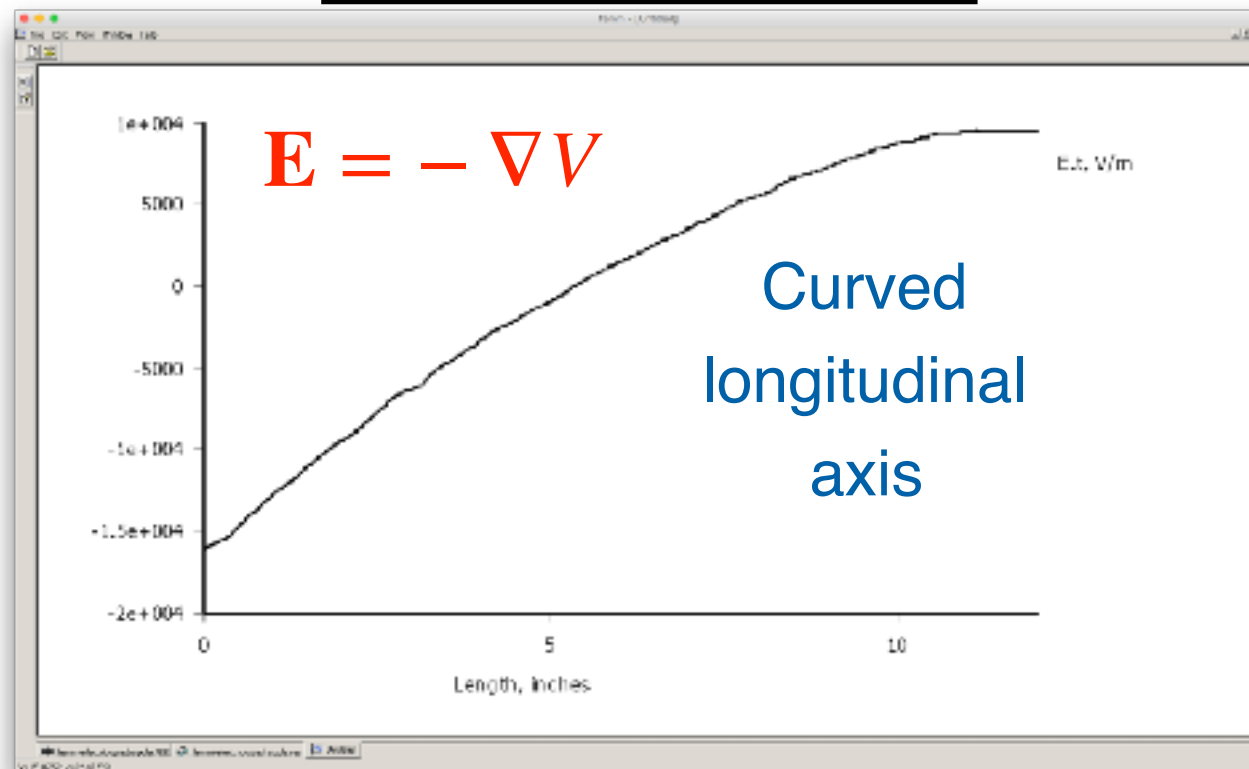
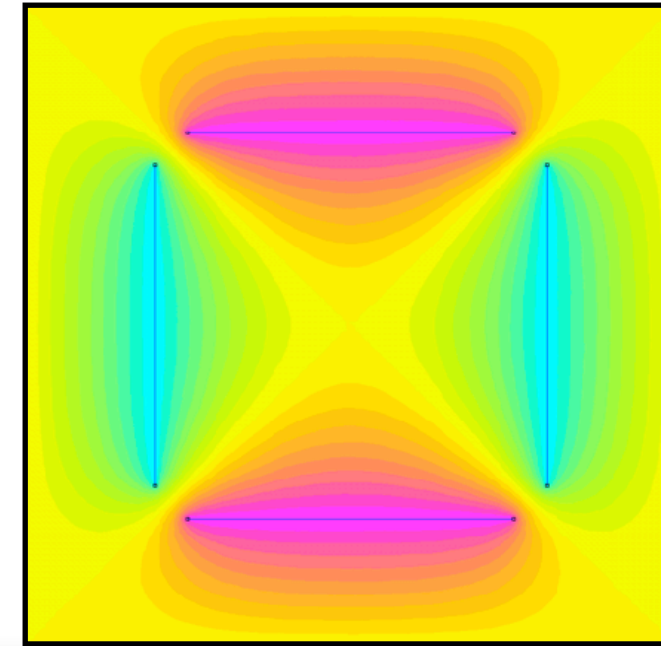
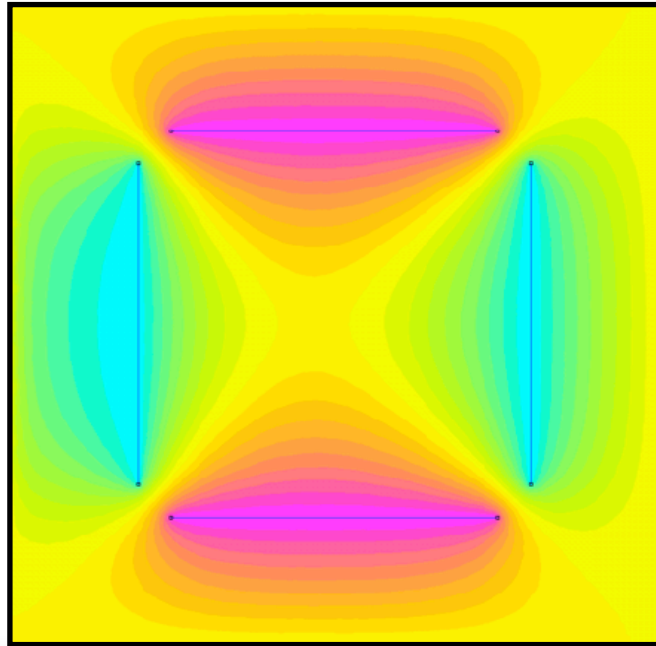

That's All For Today — See You On Thursday!

- Overview Laplace's equation and solutions
 - Cauchy-Riemann equations; Connection to electromagnetism (EM)
 - Conformal mappings
 - Shortcomings
- Finite-Element methods and codes (OPERA, COMSOL, FEMM, ...)
- Getting FEMM setup on your local machine
- FEMM electric example
 - Problem setup: Electric dipole/quadrupole
 - How to extract the potential/E-field from FEMM
- FEMM magnetic example (next time)
 - Problem setup: H-dipole, quadrupole (more challenging)
 - How to extract the potential/B-field from FEMM
- Pro Tips And Tricks (next time)
 - Scripting in `lua` and `python`; Jupyter notebooks; WebPlotDigitizer; etc.
- Conclusions